

R&S®ESCI EMI Test Receiver Operating Manual

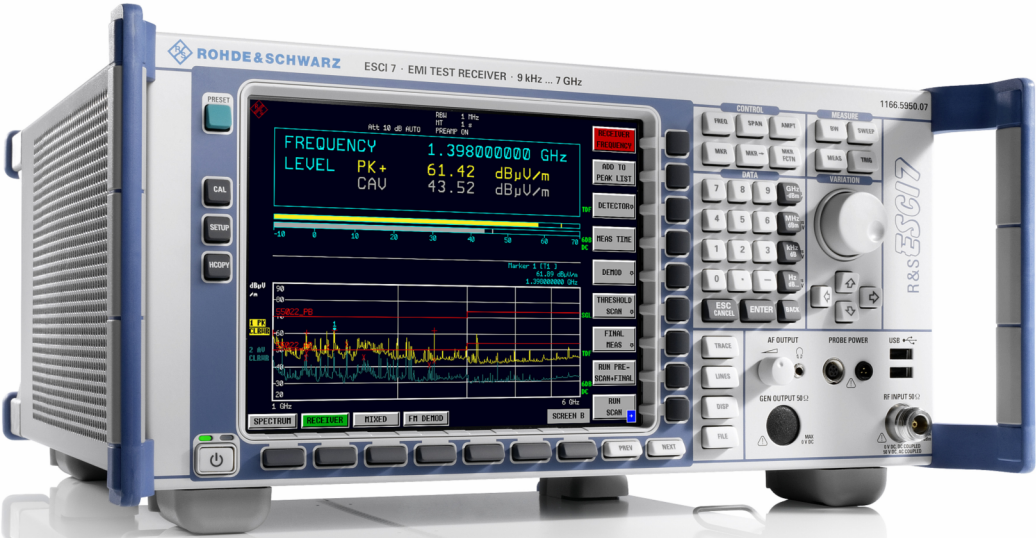

1166.6256.12 – 03

The Operating Manual describes the following R&S® ESCI models and options:

- R&S ESCI (1166.5950K03)
- R&S ESCI7 (1166.5950K07)
- R&S FSP-B6 (1129.8594.02)
- R&S FSP-B9 (1129.6991.02)
- R&S FSP-B10 (1129.8042.03)
- R&S FSP-B16 (1129.8042.03)

© 2009 Rohde & Schwarz GmbH & Co. KG

81671 Munich, Germany

Printed in Germany – Subject to change – Data without tolerance limits is not binding.

R&S® is a registered trademark of Rohde & Schwarz GmbH & Co. KG.

Trade names are trademarks of the owners.

The following abbreviations are used throughout this manual:

R&S® ESCI is abbreviated as R&S ESCI.

Basic Safety Instructions

Always read through and comply with the following safety instructions!









All plants and locations of the Rohde & Schwarz group of companies make every effort to keep the safety standards of our products up to date and to offer our customers the highest possible degree of safety. Our products and the auxiliary equipment they require are designed, built and tested in accordance with the safety standards that apply in each case. Compliance with these standards is continuously monitored by our quality assurance system. The product described here has been designed, built and tested in accordance with the attached EC Certificate of Conformity and has left the manufacturer's plant in a condition fully complying with safety standards. To maintain this condition and to ensure safe operation, you must observe all instructions and warnings provided in this manual. If you have any questions regarding these safety instructions, the Rohde & Schwarz group of companies will be happy to answer them.







Furthermore, it is your responsibility to use the product in an appropriate manner. This product is designed for use solely in industrial and laboratory environments or, if expressly permitted, also in the field and must not be used in any way that may cause personal injury or property damage. You are responsible if the product is used for any intention other than its designated purpose or in disregard of the manufacturer's instructions. The manufacturer shall assume no responsibility for such use of the product.

The product is used for its designated purpose if it is used in accordance with its product documentation and within its performance limits (see data sheet, documentation, the following safety instructions). Using the product requires technical skills and a basic knowledge of English. It is therefore essential that only skilled and specialized staff or thoroughly trained personnel with the required skills be allowed to use the product. If personal safety gear is required for using Rohde & Schwarz products, this will be indicated at the appropriate place in the product documentation. Keep the basic safety instructions and the product documentation in a safe place and pass them on to the subsequent users.

Observing the safety instructions will help prevent personal injury or damage of any kind caused by dangerous situations. Therefore, carefully read through and adhere to the following safety instructions before and when using the product. It is also absolutely essential to observe the additional safety instructions on personal safety, for example, that appear in relevant parts of the product documentation. In these safety instructions, the word "product" refers to all merchandise sold and distributed by the Rohde & Schwarz group of companies, including instruments, systems and all accessories.

Symbols and safety labels

							
Notice, general danger location Observe product documentation	Caution when handling heavy equipment	Danger of electric shock	Warning! Hot surface	PE terminal	Ground	Ground terminal	Be careful when handling electrostatic sensitive devices

					
ON/OFF supply voltage	Standby indication	Direct current (DC)	Alternating current (AC)	Direct/alternating current (DC/AC)	Device fully protected by double (reinforced) insulation

Tags and their meaning

The following signal words are used in the product documentation in order to warn the reader about risks and dangers.



indicates a hazardous situation which, if not avoided, will result in death or serious injury.



indicates a hazardous situation which, if not avoided, could result in death or serious injury.



indicates a hazardous situation which, if not avoided, could result in minor or moderate injury.



indicates the possibility of incorrect operation which can result in damage to the product.

In the product documentation, the word ATTENTION is used synonymously.

These tags are in accordance with the standard definition for civil applications in the European Economic Area. Definitions that deviate from the standard definition may also exist in other economic areas or military applications. It is therefore essential to make sure that the tags described here are always used only in connection with the related product documentation and the related product. The use of tags in connection with unrelated products or documentation can result in misinterpretation and in personal injury or material damage.

Operating states and operating positions

The product may be operated only under the operating conditions and in the positions specified by the manufacturer, without the product's ventilation being obstructed. If the manufacturer's specifications are not observed, this can result in electric shock, fire and/or serious personal injury or death. Applicable local or national safety regulations and rules for the prevention of accidents must be observed in all work performed.

1. Unless otherwise specified, the following requirements apply to Rohde & Schwarz products: predefined operating position is always with the housing floor facing down, IP protection 2X, pollution severity 2, overvoltage category 2, use only indoors, max. operating altitude 2000 m above sea level, max. transport altitude 4500 m above sea level. A tolerance of $\pm 10\%$ shall apply to the nominal voltage and $\pm 5\%$ to the nominal frequency.
2. Do not place the product on surfaces, vehicles, cabinets or tables that for reasons of weight or stability are unsuitable for this purpose. Always follow the manufacturer's installation instructions when installing the product and fastening it to objects or structures (e.g. walls and shelves). An installation that is not carried out as described in the product documentation could result in personal injury or death.
3. Do not place the product on heat-generating devices such as radiators or fan heaters. The ambient temperature must not exceed the maximum temperature specified in the product documentation or in the data sheet. Product overheating can cause electric shock, fire and/or serious personal injury or death.

Electrical safety

If the information on electrical safety is not observed either at all to the extent necessary, electric shock, fire and/or serious personal injury or death may occur.

1. Prior to switching on the product, always ensure that the nominal voltage setting on the product matches the nominal voltage of the AC supply network. If a different voltage is to be set, the power fuse of the product may have to be changed accordingly.
2. In the case of products of safety class I with movable power cord and connector, operation is permitted only on sockets with an earthing contact and protective earth connection.
3. Intentionally breaking the protective earth connection either in the feed line or in the product itself is not permitted. Doing so can result in the danger of an electric shock from the product. If extension cords or connector strips are implemented, they must be checked on a regular basis to ensure that they are safe to use.
4. If the product does not have a power switch for disconnection from the AC supply network, the plug of the connecting cable is regarded as the disconnecting device. In such cases, always ensure that the power plug is easily reachable and accessible at all times (corresponding to the length of connecting cable, approx. 2 m). Functional or electronic switches are not suitable for providing disconnection from the AC supply network. If products without power switches are integrated into racks or systems, a disconnecting device must be provided at the system level.
5. Never use the product if the power cable is damaged. Check the power cable on a regular basis to ensure that it is in proper operating condition. By taking appropriate safety measures and carefully laying the power cable, you can ensure that the cable will not be damaged and that no one can be hurt by, for example, tripping over the cable or suffering an electric shock.
6. The product may be operated only from TN/TT supply networks fused with max. 16 A (higher fuse only after consulting with the Rohde & Schwarz group of companies).
7. Do not insert the plug into sockets that are dusty or dirty. Insert the plug firmly and all the way into the socket. Otherwise, sparks that result in fire and/or injuries may occur.
8. Do not overload any sockets, extension cords or connector strips; doing so can cause fire or electric shocks.
9. For measurements in circuits with voltages $V_{\text{rms}} > 30 \text{ V}$, suitable measures (e.g. appropriate measuring equipment, fusing, current limiting, electrical separation, insulation) should be taken to avoid any hazards.
10. Ensure that the connections with information technology equipment, e.g. PCs or other industrial computers, comply with the IEC60950-1/EN60950-1 or IEC61010-1/EN 61010-1 standards that apply in each case.
11. Unless expressly permitted, never remove the cover or any part of the housing while the product is in operation. Doing so will expose circuits and components and can lead to injuries, fire or damage to the product.
12. If a product is to be permanently installed, the connection between the PE terminal on site and the product's PE conductor must be made first before any other connection is made. The product may be installed and connected only by a licensed electrician.
13. For permanently installed equipment without built-in fuses, circuit breakers or similar protective devices, the supply circuit must be fused in such a way that anyone who has access to the product, as well as the product itself, is adequately protected from injury or damage.

Basic Safety Instructions

14. Use suitable overvoltage protection to ensure that no overvoltage (such as that caused by a bolt of lightning) can reach the product. Otherwise, the person operating the product will be exposed to the danger of an electric shock.
15. Any object that is not designed to be placed in the openings of the housing must not be used for this purpose. Doing so can cause short circuits inside the product and/or electric shocks, fire or injuries.
16. Unless specified otherwise, products are not liquid-proof (see also section "Operating states and operating positions", item 1. Therefore, the equipment must be protected against penetration by liquids. If the necessary precautions are not taken, the user may suffer electric shock or the product itself may be damaged, which can also lead to personal injury.
17. Never use the product under conditions in which condensation has formed or can form in or on the product, e.g. if the product has been moved from a cold to a warm environment. Penetration by water increases the risk of electric shock.
18. Prior to cleaning the product, disconnect it completely from the power supply (e.g. AC supply network or battery). Use a soft, non-linting cloth to clean the product. Never use chemical cleaning agents such as alcohol, acetone or diluents for cellulose lacquers.

Operation

1. Operating the products requires special training and intense concentration. Make sure that persons who use the products are physically, mentally and emotionally fit enough to do so; otherwise, injuries or material damage may occur. It is the responsibility of the employer/operator to select suitable personnel for operating the products.
2. Before you move or transport the product, read and observe the section titled "Transport".
3. As with all industrially manufactured goods, the use of substances that induce an allergic reaction (allergens) such as nickel cannot be generally excluded. If you develop an allergic reaction (such as a skin rash, frequent sneezing, red eyes or respiratory difficulties) when using a Rohde & Schwarz product, consult a physician immediately to determine the cause and to prevent health problems or stress.
4. Before you start processing the product mechanically and/or thermally, or before you take it apart, be sure to read and pay special attention to the section titled "Waste disposal", item 1.
5. Depending on the function, certain products such as RF radio equipment can produce an elevated level of electromagnetic radiation. Considering that unborn babies require increased protection, pregnant women must be protected by appropriate measures. Persons with pacemakers may also be exposed to risks from electromagnetic radiation. The employer/operator must evaluate workplaces where there is a special risk of exposure to radiation and, if necessary, take measures to avert the potential danger.
6. Should a fire occur, the product may release hazardous substances (gases, fluids, etc.) that can cause health problems. Therefore, suitable measures must be taken, e.g. protective masks and protective clothing must be worn.
7. If a laser product (e.g. a CD/DVD drive) is integrated into a Rohde & Schwarz product, absolutely no other settings or functions may be used as described in the product documentation. The objective is to prevent personal injury (e.g. due to laser beams).

Repair and service

1. The product may be opened only by authorized, specially trained personnel. Before any work is performed on the product or before the product is opened, it must be disconnected from the AC supply network. Otherwise, personnel will be exposed to the risk of an electric shock.
2. Adjustments, replacement of parts, maintenance and repair may be performed only by electrical experts authorized by Rohde & Schwarz. Only original parts may be used for replacing parts relevant to safety (e.g. power switches, power transformers, fuses). A safety test must always be performed after parts relevant to safety have been replaced (visual inspection, PE conductor test, insulation resistance measurement, leakage current measurement, functional test). This helps ensure the continued safety of the product.

Batteries and rechargeable batteries/cells

If the information regarding batteries and rechargeable batteries/cells is not observed either at all or to the extent necessary, product users may be exposed to the risk of explosions, fire and/or serious personal injury, and, in some cases, death. Batteries and rechargeable batteries with alkaline electrolytes (e.g. lithium cells) must be handled in accordance with the EN 62133 standard.

1. Cells must not be taken apart or crushed.
2. Cells or batteries must not be exposed to heat or fire. Storage in direct sunlight must be avoided. Keep cells and batteries clean and dry. Clean soiled connectors using a dry, clean cloth.
3. Cells or batteries must not be short-circuited. Cells or batteries must not be stored in a box or in a drawer where they can short-circuit each other, or where they can be short-circuited by other conductive materials. Cells and batteries must not be removed from their original packaging until they are ready to be used.
4. Keep cells and batteries out of the hands of children. If a cell or a battery has been swallowed, seek medical aid immediately.
5. Cells and batteries must not be exposed to any mechanical shocks that are stronger than permitted.
6. If a cell develops a leak, the fluid must not be allowed to come into contact with the skin or eyes. If contact occurs, wash the affected area with plenty of water and seek medical aid.
7. Improperly replacing or charging cells or batteries that contain alkaline electrolytes (e.g. lithium cells) can cause explosions. Replace cells or batteries only with the matching Rohde & Schwarz type (see parts list) in order to ensure the safety of the product.
8. Cells and batteries must be recycled and kept separate from residual waste. Rechargeable batteries and normal batteries that contain lead, mercury or cadmium are hazardous waste. Observe the national regulations regarding waste disposal and recycling.

Transport

1. The product may be very heavy. Therefore, the product must be handled with care. In some cases, the user may require a suitable means of lifting or moving the product (e.g. with a lift-truck) to avoid back or other physical injuries.

2. Handles on the products are designed exclusively to enable personnel to transport the product. It is therefore not permissible to use handles to fasten the product to or on transport equipment such as cranes, fork lifts, wagons, etc. The user is responsible for securely fastening the products to or on the means of transport or lifting. Observe the safety regulations of the manufacturer of the means of transport or lifting. Noncompliance can result in personal injury or material damage.
3. If you use the product in a vehicle, it is the sole responsibility of the driver to drive the vehicle safely and properly. The manufacturer assumes no responsibility for accidents or collisions. Never use the product in a moving vehicle if doing so could distract the driver of the vehicle. Adequately secure the product in the vehicle to prevent injuries or other damage in the event of an accident.

Waste disposal

1. If products or their components are mechanically and/or thermally processed in a manner that goes beyond their intended use, hazardous substances (heavy-metal dust such as lead, beryllium, nickel) may be released. For this reason, the product may only be disassembled by specially trained personnel. Improper disassembly may be hazardous to your health. National waste disposal regulations must be observed.
2. If handling the product releases hazardous substances or fuels that must be disposed of in a special way, e.g. coolants or engine oils that must be replenished regularly, the safety instructions of the manufacturer of the hazardous substances or fuels and the applicable regional waste disposal regulations must be observed. Also observe the relevant safety instructions in the product documentation. The improper disposal of hazardous substances or fuels can cause health problems and lead to environmental damage.

Informaciones elementales de seguridad

Es imprescindible leer y observar las siguientes instrucciones e informaciones de seguridad!

El principio del grupo de empresas Rohde & Schwarz consiste en tener nuestros productos siempre al día con los estándares de seguridad y de ofrecer a nuestros clientes el máximo grado de seguridad. Nuestros productos y todos los equipos adicionales son siempre fabricados y examinados según las normas de seguridad vigentes. Nuestro sistema de garantía de calidad controla constantemente que sean cumplidas estas normas. El presente producto ha sido fabricado y examinado según el certificado de conformidad adjunto de la UE y ha salido de nuestra planta en estado impecable según los estándares técnicos de seguridad. Para poder preservar este estado y garantizar un funcionamiento libre de peligros, el usuario deberá atenerse a todas las indicaciones, informaciones de seguridad y notas de alerta. El grupo de empresas Rohde & Schwarz está siempre a su disposición en caso de que tengan preguntas referentes a estas informaciones de seguridad.

Además queda en la responsabilidad del usuario utilizar el producto en la forma debida. Este producto está destinado exclusivamente al uso en la industria y el laboratorio o, si ha sido expresamente autorizado, para aplicaciones de campo y de ninguna manera deberá ser utilizado de modo que alguna persona/cosa pueda sufrir daño. El uso del producto fuera de sus fines definidos o sin tener en cuenta las instrucciones del fabricante queda en la responsabilidad del usuario. El fabricante no se hace en ninguna forma responsable de consecuencias a causa del mal uso del producto.







Informaciones elementales de seguridad

Se parte del uso correcto del producto para los fines definidos si el producto es utilizado conforme a las indicaciones de la correspondiente documentación del producto y dentro del margen de rendimiento definido (ver hoja de datos, documentación, informaciones de seguridad que siguen). El uso del producto hace necesarios conocimientos técnicos y ciertos conocimientos del idioma inglés. Por eso se debe tener en cuenta que el producto solo pueda ser operado por personal especializado o personas instruidas en profundidad con las capacidades correspondientes. Si fuera necesaria indumentaria de seguridad para el uso de productos de Rohde & Schwarz, encontraría la información debida en la documentación del producto en el capítulo correspondiente. Guarde bien las informaciones de seguridad elementales, así como la documentación del producto, y entréguelas a usuarios posteriores.

Tener en cuenta las informaciones de seguridad sirve para evitar en lo posible lesiones o daños por peligros de toda clase. Por eso es imprescindible leer detalladamente y comprender por completo las siguientes informaciones de seguridad antes de usar el producto, y respetarlas durante el uso del producto. Deberán tenerse en cuenta todas las demás informaciones de seguridad, como p. ej. las referentes a la protección de personas, que encontrarán en el capítulo correspondiente de la documentación del producto y que también son de obligado cumplimiento. En las presentes informaciones de seguridad se recogen todos los objetos que distribuye el grupo de empresas Rohde & Schwarz bajo la denominación de "producto", entre ellos también aparatos, instalaciones así como toda clase de accesorios.

Símbolos y definiciones de seguridad

							
Aviso: punto de peligro general Observar la documentación del producto	Atención en el manejo de dispositivos de peso elevado	Peligro de choque eléctrico	Advertencia: superficie caliente	Conexión a conductor de protección	Conexión a tierra	Conexión a masa	Aviso: Cuidado en el manejo de dispositivos sensibles a la electrostática (ESD)

					
Tensión de alimentación de PUESTA EN MARCHA / PARADA	Indicación de estado de espera (Standby)	Corriente continua (DC)	Corriente alterna (AC)	Corriente continua / Corriente alterna (DC/AC)	El aparato está protegido en su totalidad por un aislamiento doble (reforzado)

Palabras de señal y su significado

En la documentación del producto se utilizan las siguientes palabras de señal con el fin de advertir contra riesgos y peligros.



PELIGRO identifica un peligro inminente con riesgo elevado que provocará muerte o lesiones graves si no se evita.



ADVERTENCIA identifica un posible peligro con riesgo medio de provocar muerte o lesiones (graves) si no se evita.



ATENCIÓN identifica un peligro con riesgo reducido de provocar lesiones leves o moderadas si no se evita.



AVISO indica la posibilidad de utilizar mal el producto y, como consecuencia, dañarlo.

En la documentación del producto se emplea de forma sinónima el término CUIDADO.

Las palabras de señal corresponden a la definición habitual para aplicaciones civiles en el área económica europea. Pueden existir definiciones diferentes a esta definición en otras áreas económicas o en aplicaciones militares. Por eso se deberá tener en cuenta que las palabras de señal aquí descritas sean utilizadas siempre solamente en combinación con la correspondiente documentación del producto y solamente en combinación con el producto correspondiente. La utilización de las palabras de señal en combinación con productos o documentaciones que no les correspondan puede llevar a interpretaciones equivocadas y tener por consecuencia daños en personas u objetos.

Estados operativos y posiciones de funcionamiento

El producto solamente debe ser utilizado según lo indicado por el fabricante respecto a los estados operativos y posiciones de funcionamiento sin que se obstruya la ventilación. Si no se siguen las indicaciones del fabricante, pueden producirse choques eléctricos, incendios y/o lesiones graves con posible consecuencia de muerte. En todos los trabajos deberán ser tenidas en cuenta las normas nacionales y locales de seguridad del trabajo y de prevención de accidentes.

1. Si no se convino de otra manera, es para los productos Rohde & Schwarz válido lo que sigue: como posición de funcionamiento se define por principio la posición con el suelo de la caja para abajo, modo de protección IP 2X, grado de suciedad 2, categoría de sobrecarga eléctrica 2, uso solamente en estancias interiores, utilización hasta 2000 m sobre el nivel del mar, transporte hasta 4500 m sobre el nivel del mar. Se aplicará una tolerancia de $\pm 10\%$ sobre el voltaje nominal y de $\pm 5\%$ sobre la frecuencia nominal.
2. No sitúe el producto encima de superficies, vehículos, estantes o mesas, que por sus características de peso o de estabilidad no sean aptos para él. Siga siempre las instrucciones de instalación del fabricante cuando instale y asegure el producto en objetos o estructuras (p. ej. paredes y estantes). Si se realiza la instalación de modo distinto al indicado en la documentación del producto, pueden causarse lesiones o incluso la muerte.
3. No ponga el producto sobre aparatos que generen calor (p. ej. radiadores o calefactores). La temperatura ambiente no debe superar la temperatura máxima especificada en la documentación del producto o en la hoja de datos. En caso de sobrecalentamiento del producto, pueden producirse choques eléctricos, incendios y/o lesiones graves con posible consecuencia de muerte.

Seguridad eléctrica

Si no se siguen (o se siguen de modo insuficiente) las indicaciones del fabricante en cuanto a seguridad eléctrica, pueden producirse choques eléctricos, incendios y/o lesiones graves con posible consecuencia de muerte.

1. Antes de la puesta en marcha del producto se deberá comprobar siempre que la tensión preseleccionada en el producto coincida con la de la red de alimentación eléctrica. Si es necesario modificar el ajuste de tensión, también se deberán cambiar en caso dado los fusibles correspondientes del producto.
2. Los productos de la clase de protección I con alimentación móvil y enchufe individual solamente podrán enchufarse a tomas de corriente con contacto de seguridad y con conductor de protección conectado.
3. Queda prohibida la interrupción intencionada del conductor de protección, tanto en la toma de corriente como en el mismo producto. La interrupción puede tener como consecuencia el riesgo de que el producto sea fuente de choques eléctricos. Si se utilizan cables alargadores o regletas de enchufe, deberá garantizarse la realización de un examen regular de los mismos en cuanto a su estado técnico de seguridad.
4. Si el producto no está equipado con un interruptor para desconectarlo de la red, se deberá considerar el enchufe del cable de conexión como interruptor. En estos casos se deberá asegurar que el enchufe siempre sea de fácil acceso (de acuerdo con la longitud del cable de conexión, aproximadamente 2 m). Los interruptores de función o electrónicos no son aptos para el corte de la red eléctrica. Si los productos sin interruptor están integrados en bastidores o instalaciones, se deberá colocar el interruptor en el nivel de la instalación.
5. No utilice nunca el producto si está dañado el cable de conexión a red. Compruebe regularmente el correcto estado de los cables de conexión a red. Asegúrese, mediante las medidas de protección y de instalación adecuadas, de que el cable de conexión a red no pueda ser dañado o de que nadie pueda ser dañado por él, p. ej. al tropezar o por un choque eléctrico.
6. Solamente está permitido el funcionamiento en redes de alimentación TN/TT aseguradas con fusibles de 16 A como máximo (utilización de fusibles de mayor amperaje solo previa consulta con el grupo de empresas Rohde & Schwarz).
7. Nunca conecte el enchufe en tomas de corriente sucias o llenas de polvo. Introduzca el enchufe por completo y fuertemente en la toma de corriente. La no observación de estas medidas puede provocar chispas, fuego y/o lesiones.
8. No sobrecargue las tomas de corriente, los cables alargadores o las regletas de enchufe ya que esto podría causar fuego o choques eléctricos.
9. En las mediciones en circuitos de corriente con una tensión $U_{\text{eff}} > 30 \text{ V}$ se deberán tomar las medidas apropiadas para impedir cualquier peligro (p. ej. medios de medición adecuados, seguros, limitación de tensión, corte protector, aislamiento etc.).
10. Para la conexión con dispositivos informáticos como un PC o un ordenador industrial, debe comprobarse que éstos cumplan los estándares IEC60950-1/EN60950-1 o IEC61010-1/EN 61010-1 válidos en cada caso.
11. A menos que esté permitido expresamente, no retire nunca la tapa ni componentes de la carcasa mientras el producto esté en servicio. Esto pone a descubierto los cables y componentes eléctricos y puede causar lesiones, fuego o daños en el producto.

12. Si un producto se instala en un lugar fijo, se deberá primero conectar el conductor de protección fijo con el conductor de protección del producto antes de hacer cualquier otra conexión. La instalación y la conexión deberán ser efectuadas por un electricista especializado.
13. En el caso de dispositivos fijos que no estén provistos de fusibles, interruptor automático ni otros mecanismos de seguridad similares, el circuito de alimentación debe estar protegido de modo que todas las personas que puedan acceder al producto, así como el producto mismo, estén a salvo de posibles daños.
14. Todo producto debe estar protegido contra sobretensión (debida p. ej. a una caída del rayo) mediante los correspondientes sistemas de protección. Si no, el personal que lo utilice quedará expuesto al peligro de choque eléctrico.
15. No debe introducirse en los orificios de la caja del aparato ningún objeto que no esté destinado a ello. Esto puede producir cortocircuitos en el producto y/o puede causar choques eléctricos, fuego o lesiones.
16. Salvo indicación contraria, los productos no están impermeabilizados (ver también el capítulo "Estados operativos y posiciones de funcionamiento", punto 1). Por eso es necesario tomar las medidas necesarias para evitar la entrada de líquidos. En caso contrario, existe peligro de choque eléctrico para el usuario o de daños en el producto, que también pueden redundar en peligro para las personas.
17. No utilice el producto en condiciones en las que pueda producirse o ya se hayan producido condensaciones sobre el producto o en el interior de éste, como p. ej. al desplazarlo de un lugar frío a otro caliente. La entrada de agua aumenta el riesgo de choque eléctrico.
18. Antes de la limpieza, desconecte por completo el producto de la alimentación de tensión (p. ej. red de alimentación o batería). Realice la limpieza de los aparatos con un paño suave, que no se deshilache. No utilice bajo ningún concepto productos de limpieza químicos como alcohol, acetona o diluyentes para lacas nitrocelulósicas.

Funcionamiento

1. El uso del producto requiere instrucciones especiales y una alta concentración durante el manejo. Debe asegurarse que las personas que manejen el producto estén a la altura de los requerimientos necesarios en cuanto a aptitudes físicas, psíquicas y emocionales, ya que de otra manera no se pueden excluir lesiones o daños de objetos. El empresario u operador es responsable de seleccionar el personal usuario apto para el manejo del producto.
2. Antes de desplazar o transportar el producto, lea y tenga en cuenta el capítulo "Transporte".
3. Como con todo producto de fabricación industrial no puede quedar excluida en general la posibilidad de que se produzcan alergias provocadas por algunos materiales empleados, los llamados alérgenos (p. ej. el níquel). Si durante el manejo de productos Rohde & Schwarz se producen reacciones alérgicas, como p. ej. irritaciones cutáneas, estornudos continuos, enrojecimiento de la conjuntiva o dificultades respiratorias, debe avisarse inmediatamente a un médico para investigar las causas y evitar cualquier molestia o daño a la salud.
4. Antes de la manipulación mecánica y/o térmica o el desmontaje del producto, debe tenerse en cuenta imprescindiblemente el capítulo "Eliminación", punto 1.

5. Ciertos productos, como p. ej. las instalaciones de radiocomunicación RF, pueden a causa de su función natural, emitir una radiación electromagnética aumentada. Deben tomarse todas las medidas necesarias para la protección de las mujeres embarazadas. También las personas con marcapasos pueden correr peligro a causa de la radiación electromagnética. El empresario/operador tiene la obligación de evaluar y señalar las áreas de trabajo en las que exista un riesgo elevado de exposición a radiaciones.
6. Tenga en cuenta que en caso de incendio pueden desprenderse del producto sustancias tóxicas (gases, líquidos etc.) que pueden generar daños a la salud. Por eso, en caso de incendio deben usarse medidas adecuadas, como p. ej. máscaras antigás e indumentaria de protección.
7. En caso de que un producto Rohde & Schwarz contenga un producto láser (p. ej. un lector de CD/DVD), no debe usarse ninguna otra configuración o función aparte de las descritas en la documentación del producto, a fin de evitar lesiones (p. ej. debidas a irradiación láser).

Reparación y mantenimiento

1. El producto solamente debe ser abierto por personal especializado con autorización para ello. Antes de manipular el producto o abrirlo, es obligatorio desconectarlo de la tensión de alimentación, para evitar toda posibilidad de choque eléctrico.
2. El ajuste, el cambio de partes, el mantenimiento y la reparación deberán ser efectuadas solamente por electricistas autorizados por Rohde & Schwarz. Si se reponen partes con importancia para los aspectos de seguridad (p. ej. el enchufe, los transformadores o los fusibles), solamente podrán ser sustituidos por partes originales. Después de cada cambio de partes relevantes para la seguridad deberá realizarse un control de seguridad (control a primera vista, control del conductor de protección, medición de resistencia de aislamiento, medición de la corriente de fuga, control de funcionamiento). Con esto queda garantizada la seguridad del producto.

Baterías y acumuladores o celdas

Si no se siguen (o se siguen de modo insuficiente) las indicaciones en cuanto a las baterías y acumuladores o celdas, pueden producirse explosiones, incendios y/o lesiones graves con posible consecuencia de muerte. El manejo de baterías y acumuladores con electrolitos alcalinos (p. ej. celdas de litio) debe seguir el estándar EN 62133.

1. No deben desmontarse, abrirse ni triturarse las celdas.
2. Las celdas o baterías no deben someterse a calor ni fuego. Debe evitarse el almacenamiento a la luz directa del sol. Las celdas y baterías deben mantenerse limpias y secas. Limpiar las conexiones sucias con un paño seco y limpio.
3. Las celdas o baterías no deben cortocircuitarse. Es peligroso almacenar las celdas o baterías en estuches o cajones en cuyo interior puedan cortocircuitarse por contacto recíproco o por contacto con otros materiales conductores. No deben extraerse las celdas o baterías de sus embalajes originales hasta el momento en que vayan a utilizarse.
4. Mantener baterías y celdas fuera del alcance de los niños. En caso de ingestión de una celda o batería, avisar inmediatamente a un médico.
5. Las celdas o baterías no deben someterse a impactos mecánicos fuertes indebidos.

Informaciones elementales de seguridad

6. En caso de falta de estanqueidad de una celda, el líquido vertido no debe entrar en contacto con la piel ni los ojos. Si se produce contacto, lavar con agua abundante la zona afectada y avisar a un médico.
7. En caso de cambio o recarga inadecuados, las celdas o baterías que contienen electrolitos alcalinos (p. ej. las celdas de litio) pueden explotar. Para garantizar la seguridad del producto, las celdas o baterías solo deben ser sustituidas por el tipo Rohde & Schwarz correspondiente (ver lista de recambios).
8. Las baterías y celdas deben reciclarse y no deben tirarse a la basura doméstica. Las baterías o acumuladores que contienen plomo, mercurio o cadmio deben tratarse como residuos especiales. Respete en esta relación las normas nacionales de eliminación y reciclaje.

Transporte

1. El producto puede tener un peso elevado. Por eso es necesario desplazarlo o transportarlo con precaución y, si es necesario, usando un sistema de elevación adecuado (p. ej. una carretilla elevadora), a fin de evitar lesiones en la espalda u otros daños personales.
2. Las asas instaladas en los productos sirven solamente de ayuda para el transporte del producto por personas. Por eso no está permitido utilizar las asas para la sujeción en o sobre medios de transporte como p. ej. grúas, carretillas elevadoras de horquilla, carros etc. Es responsabilidad suya fijar los productos de manera segura a los medios de transporte o elevación. Para evitar daños personales o daños en el producto, siga las instrucciones de seguridad del fabricante del medio de transporte o elevación utilizado.
3. Si se utiliza el producto dentro de un vehículo, recae de manera exclusiva en el conductor la responsabilidad de conducir el vehículo de manera segura y adecuada. El fabricante no asumirá ninguna responsabilidad por accidentes o colisiones. No utilice nunca el producto dentro de un vehículo en movimiento si esto pudiera distraer al conductor. Asegure el producto dentro del vehículo debidamente para evitar, en caso de un accidente, lesiones u otra clase de daños.

Eliminación

1. Si se trabaja de manera mecánica y/o térmica cualquier producto o componente más allá del funcionamiento previsto, pueden liberarse sustancias peligrosas (polvos con contenido de metales pesados como p. ej. plomo, berilio o níquel). Por eso el producto solo debe ser desmontado por personal especializado con formación adecuada. Un desmontaje inadecuado puede ocasionar daños para la salud. Se deben tener en cuenta las directivas nacionales referentes a la eliminación de residuos.
2. En caso de que durante el trato del producto se formen sustancias peligrosas o combustibles que deban tratarse como residuos especiales (p. ej. refrigerantes o aceites de motor con intervalos de cambio definidos), deben tenerse en cuenta las indicaciones de seguridad del fabricante de dichas sustancias y las normas regionales de eliminación de residuos. Tenga en cuenta también en caso necesario las indicaciones de seguridad especiales contenidas en la documentación del producto. La eliminación incorrecta de sustancias peligrosas o combustibles puede causar daños a la salud o daños al medio ambiente.

Kundeninformation zur Batterieverordnung (BattV)

Dieses Gerät enthält eine schadstoffhaltige Batterie. Diese darf nicht mit dem Hausmüll entsorgt werden.

Nach Ende der Lebensdauer darf die Entsorgung nur über eine Rohde&Schwarz-Kundendienststelle oder eine geeignete Sammelstelle erfolgen.

Safety Regulations for Batteries (according to BattV)

This equipment houses a battery containing harmful substances that must not be disposed of as normal household waste.

After its useful life, the battery may only be disposed of at a Rohde & Schwarz service center or at a suitable depot.

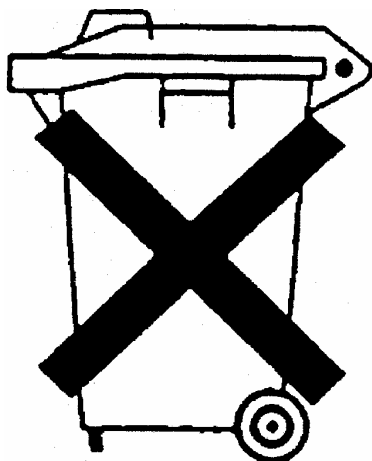

Normas de Seguridad para Baterías (Según BattV)

Este equipo lleva una batería que contiene sustancias perjudiciales, que no se debe desechar en los contenedores de basura domésticos.

Después de la vida útil, la batería sólo se podrá eliminar en un centro de servicio de Rohde & Schwarz o en un depósito apropiado.

Consignes de sécurité pour batteries (selon BattV)

Cet appareil est équipé d'une pile comprenant des substances nocives. Ne jamais la jeter dans une poubelle pour ordures ménagères.

Une pile usagée doit uniquement être éliminée par un centre de service client de Rohde & Schwarz ou peut être collectée pour être traitée spécialement comme déchets dangereux.

Customer Information Regarding Product Disposal

The German Electrical and Electronic Equipment (ElektroG) Act is an implementation of the following EC directives:

- 2002/96/EC on waste electrical and electronic equipment (WEEE) and
- 2002/95/EC on the restriction of the use of certain hazardous substances in electrical and electronic equipment (RoHS).

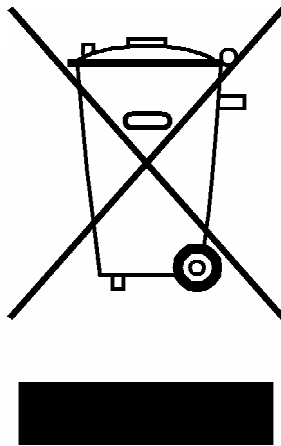

Product labeling in accordance with EN 50419

Once the lifetime of a product has ended, this product must not be disposed of in the standard domestic refuse. Even disposal via the municipal collection points for waste electrical and electronic equipment is not permitted.

Rohde & Schwarz GmbH & Co. KG has developed a disposal concept for the environmental-friendly disposal or recycling of waste material and fully assumes its obligation as a producer to take back and dispose of electrical and electronic waste in accordance with the ElektroG Act.

Please contact your local service representative to dispose of the product.



Certified Quality System

DIN EN ISO 9001 : 2000
DIN EN 9100 : 2003
DIN EN ISO 14001 : 2004

DQS REG. NO 001954 QM UM

QUALITÄTSZERTIFIKAT

Sehr geehrter Kunde,
Sie haben sich für den Kauf eines Rohde & Schwarz-Produktes entschieden. Hiermit erhalten Sie ein nach modernsten Fertigungsmethoden hergestelltes Produkt. Es wurde nach den Regeln unseres Managementsystems entwickelt, gefertigt und geprüft. Das Rohde & Schwarz Managementsystem ist zertifiziert nach:

DIN EN ISO 9001:2000
DIN EN 9100:2003
DIN EN ISO 14001:2004

CERTIFICATE OF QUALITY

Dear Customer,
you have decided to buy a Rohde & Schwarz product. You are thus assured of receiving a product that is manufactured using the most modern methods available. This product was developed, manufactured and tested in compliance with our quality management system standards. The Rohde & Schwarz quality management system is certified according to:

DIN EN ISO 9001:2000
DIN EN 9100:2003
DIN EN ISO 14001:2004

CERTIFICAT DE QUALITÉ

Cher Client,
vous avez choisi d'acheter un produit Rohde & Schwarz. Vous disposez donc d'un produit fabriqué d'après les méthodes les plus avancées. Le développement, la fabrication et les tests respectent nos normes de gestion qualité. Le système de gestion qualité de Rohde & Schwarz a été homologué conformément aux normes:

DIN EN ISO 9001:2000
DIN EN 9100:2003
DIN EN ISO 14001:2004





ROHDE & SCHWARZ

EC Certificate of Conformity



Certificate No.: 2004-13

This is to certify that:

Equipment type	Stock No.	Designation
ESCI	1166.5950.03	EMI Test Receiver
ESCI7	1166.5950.07	EMI Test Receiver
ESCI-B20	1155.1606.xx	Extended Environment Specification

complies with the provisions of the Directive of the Council of the European Union on the approximation of the laws of the Member States

- relating to electrical equipment for use within defined voltage limits (2006/95/EC)
- relating to electromagnetic compatibility (2004/108/EC)

Conformity is proven by compliance with the following standards:

EN 61010-1: 2001
EN 61326-1: 2006
EN 61326-2-1: 2006
EN 55011: 2007 + A2: 2007

For the assessment of electromagnetic compatibility, the limits of radio interference for Class B equipment as well as the immunity to interference for operation in industry have been used as a basis.

ROHDE & SCHWARZ GmbH & Co. KG
Mühlldorfstr. 15, D-81671 München

Munich, 2009-06-30

Central Quality Management MF-QZ / Radde

1166.5950.xx

CE

E-3

Customer Support

Technical support – where and when you need it

For quick, expert help with any Rohde & Schwarz equipment, contact one of our Customer Support Centers. A team of highly qualified engineers provides telephone support and will work with you to find a solution to your query on any aspect of the operation, programming or applications of Rohde & Schwarz equipment.

Up-to-date information and upgrades

To keep your instrument up-to-date and to be informed about new application notes related to your instrument, please send an e-mail to the Customer Support Center stating your instrument and your wish. We will take care that you will get the right information.

USA & Canada

Monday to Friday (except US public holidays)
8:00 AM – 8:00 PM Eastern Standard Time (EST)

Tel. from USA 888-test-rsa (888-837-8772) (opt 2)
From outside USA +1 410 910 7800 (opt 2)
Fax +1 410 910 7801
E-mail CustomerSupport@rohde-schwarz.com

East Asia

Monday to Friday (except Singaporean public holidays)
8:30 AM – 6:00 PM Singapore Time (SGT)

Tel. +65 6 513 0488
Fax +65 6 846 1090
E-mail CustomerSupport@rohde-schwarz.com

Rest of the World

Monday to Friday (except German public holidays)
08:00 – 17:00 Central European Time (CET)

Tel. from Europe +49 (0) 180 512 42 42*
From outside Europe +49 89 4129 13776
Fax +49 (0) 89 41 29 637 78
E-mail CustomerSupport@rohde-schwarz.com

* 0.14 €/Min within the German fixed-line telephone network, varying prices for the mobile telephone network and in different countries.



Address List

Headquarters, Plants and Subsidiaries

Headquarters

ROHDE & SCHWARZ GmbH & Co. KG
Mühlendorfstraße 15 · D-81671 München
P.O.Box 80 14 69 · D-81614 München

Phone +49 (89) 41 29-0
Fax +49 (89) 41 29-121 64
info.rs@rohde-schwarz.com

Plants

ROHDE & SCHWARZ Messgerätebau GmbH
Riedbachstraße 58 · D-87700 Memmingen
P.O.Box 16 52 · D-87686 Memmingen

Phone +49 (83 31) 1 08-0
+49 (83 31) 1 08-1124
info.rsmb@rohde-schwarz.com

ROHDE & SCHWARZ GmbH & Co. KG
Werk Teisnach
Kaikenrieder Straße 27 · D-94244 Teisnach
P.O.Box 11 49 · D-94240 Teisnach

Phone +49 (99 23) 8 50-0
Fax +49 (99 23) 8 50-174
info.rsdt@rohde-schwarz.com

ROHDE & SCHWARZ závod
Vimperk, s.r.o.
Location Spidrova 49
CZ-38501 Vimperk

Phone +420 (388) 45 21 09
Fax +420 (388) 45 21 13

ROHDE & SCHWARZ GmbH & Co. KG
Dienstleistungszentrum Köln
Graf-Zeppelin-Straße 18 · D-51147 Köln
P.O.Box 98 02 60 · D-51130 Köln

Phone +49 (22 03) 49-0
Fax +49 (22 03) 49 51-229
info.rsd@rohde-schwarz.com
service.rsd@rohde-schwarz.com

Subsidiaries

R&S BICK Mobilfunk GmbH
Fritz-Hahne-Str. 7 · D-31848 Bad Münder
P.O.Box 20 02 · D-31844 Bad Münder

Phone +49 (50 42) 9 98-0
Fax +49 (50 42) 9 98-105
info.bick@rohde-schwarz.com

ROHDE & SCHWARZ FTK GmbH
Wendenschloßstraße 168, Haus 28
D-12557 Berlin

Phone +49 (30) 658 91-122
Fax +49 (30) 655 50-221
info.ftk@rohde-schwarz.com

ROHDE & SCHWARZ SIT GmbH
Am Studio 3
D-12489 Berlin

Phone +49 (30) 658 84-0
Fax +49 (30) 658 84-183
info.sit@rohde-schwarz.com

R&S Systems GmbH
Graf-Zeppelin-Straße 18
D-51147 Köln

Phone +49 (22 03) 49-5 23 25
Fax +49 (22 03) 49-5 23 36
info.rssys@rohde-schwarz.com

GEDIS GmbH
Sophienblatt 100
D-24114 Kiel

Phone +49 (431) 600 51-0
Fax +49 (431) 600 51-11
sales@gedis-online.de

HAMEG Instruments GmbH
Industriestraße 6
D-63533 Mainhausen

Phone +49 (61 82) 800-0
Fax +49 (61 82) 800-100
info@hameg.de

Locations Worldwide

Please refer to our homepage: www.rohde-schwarz.com

- ◆ Sales Locations
- ◆ Service Locations
- ◆ National Websites

Tabbed Divider Overview

Safety Instructions are provided on the CD-ROM

Tabbed Divider

Documentation Overview

Chapter 1: [Putting into Operation](#)

Chapter 3: [Manual Operation](#)

Chapter 4: [Instrument Functions](#)

Chapter 5: [Remote Control – Basics](#)

Chapter 6: [Remote Control – Description of Commands](#)

Chapter 7: [Remote Control – Programming Examples](#)

Chapter 8: [Maintenance and Instrument Interfaces](#)

Chapter 9: [Error Messages](#)

Index

Documentation Overview

The documentation of the R&S ESCI consists of base unit manuals and option manuals. All manuals are provided in PDF format on the CD-ROM delivered with the instrument. Each software option available for the instrument is described in a separate software manual.

The base unit documentation comprises the following manuals and documents:

- [Quick Start Guide](#)
- [Operating Manual](#)
- [Service Manual](#)
- [Internet Site](#)
- [Release Notes](#)

Apart from the base unit, these manuals describe the following models and options of the R&S ESCI EMI Test Receiver. Options that are not listed are described in separate manuals. These manuals are provided on an extra CD-ROM. For an overview of all options available for the R&S ESCI visit the R&S ESCI EMI Test Receiver Internet site.

Base unit models

- R&S ESCI
- R&S ESCI7

Options described in the base unit manuals:

- R&S FSP-B3 (Audio Demodulator, implemented)
- R&S FSP-B4 (OCXO - Reference Oscillator)
- R&S FSP-B6 (TV and RF Trigger)
- R&S FSP-B9 (Tracking Generator)
- R&S FSP-B10 (External Generator Control)
- R&S FSP-B16 (LAN Interface, implemented)
- R&S ESCI-B20 (Extended Environmental Specification)

Quick Start Guide

This manual is delivered with the instrument in printed form and in PDF format on the CD-ROM. It provides the information needed to set up and start working with the instrument. Basic operations and basic measurements are described. Also a brief introduction to remote control is given. More detailed descriptions are provided in the Operating Manual. The Quick Start Guide includes general information (e.g. Safety Instructions) and the following chapters:

Chapter 1	Front and Rear Panel
Chapter 2	Preparing for Use
Chapter 3	Firmware-Update and Installation of Firmware Options
Chapter 4	Basic Operation
Chapter 5	Basic Measurement Examples
Chapter 6	LAN Interface
Appendix A	Printer Interface
Appendix B	External Generator Control
Appendix C	Brief Introduction to Remote Control

Operating Manual

This manual is a supplement to the Quick Start Guide and is available in PDF format on the CD-ROM delivered with the instrument. To retain the familiar structure that applies to all operating manuals of Rohde&Schwarz Test & Measurement instruments, the chapters 1 and 3 exist, but only in form of references to the corresponding Quick Start Guide chapters.

The operating manual is subdivided into the following chapters:

Chapter 1	Putting into Operation see Quick Start Guide chapters 1 and 2.
Chapter 2	Getting Started see Quick Start Guide chapter 5.
Chapter 3	Manual Operation see Quick Start Guide chapter 4.
Chapter 4	Instrument Functions forms a reference for manual operation of the R&S ESCI and contains a detailed description of all instrument functions and their application.
Chapter 5	Remote Control - Basics describes the basics for programming the R&S ESCI, command processing and the status reporting system.
Chapter 6	Remote Control - Description of Commands lists all the remote-control commands defined for the instrument.
Chapter 7	Remote Control - Programming Examples contains program examples for a number of typical applications of the R&S ESCI.
Chapter 8	Maintenance and Instrument Interfaces describes preventive maintenance and the characteristics of the instrument's interfaces.
Chapter 9	Error Messages gives a list of error messages that the R&S ESCI may generate.
Index	contains an index for the chapters 1 to 9 of the operating manual.

Service Manual

This manual is available in PDF format on the CD-ROM delivered with the instrument. It informs on how to check compliance with rated specifications, on instrument function, repair, troubleshooting and fault elimination. It contains all information required for repairing the R&S ESCI by the replacement of modules. The manual includes the following chapters:

- Chapter 1** Performance Test
- Chapter 2** Adjustment
- Chapter 3** Repair
- Chapter 4** Software Update / Installing Options
- Chapter 5** Documents

Internet Site

The Internet site at: [R&S ESCI EMI Test Receiver](#) provides the most up to date information on the R&S ESCI.

The current operating manual at a time is available as printable PDF file in the download area. Also provided for download are firmware updates including the associated release notes, instrument drivers, current data sheets and application notes.

Release Notes

The release notes describe the installation of the firmware, new and modified functions, eliminated problems, and last minute changes to the documentation. The corresponding firmware version is indicated on the title page of the release notes. The current release notes are provided in the Internet.

1 Putting into Operation

For details refer to the Quick Start Guide chapter 1, “Front and Rear Panel” and chapter 2, “Preparing for Use”.

2 Getting Started

For details refer to the Quick Start Guide chapter 1, [“Basic Measurement Examples”](#).

3 Manual Operation

For details refer to the Quick Start Guide chapter 4, "Basic Operation".

4 Instrument Functions

4.1 Introduction	4.5
4.2 R&S ESCI Initial Configuration – PRESET Key	4.6
4.3 Mode Selection – Hotkey Bar	4.9
4.4 Return to Manual Operation – LOCAL Menu	4.10
4.5 Receiver Mode	4.11
4.5.1 Operation on a Discrete Frequency – FREQ Key	4.14
4.5.2 Level Display and RF Input Configuration – AMPT Key	4.16
4.5.3 Setting the IF Bandwidth – BW Key	4.19
4.5.3.1 List of Available Channel Filters	4.21
4.5.4 Selection of the Measurement Function – MEAS Key	4.23
4.5.4.1 Selecting the Detector	4.26
4.5.4.2 Setting the Measurement Time	4.28
4.5.4.3 AF Demodulators	4.30
4.5.4.4 Data Reduction and Peak List	4.31
4.5.4.5 Automatic Final Measurement with Threshold Scan	4.33
4.5.4.6 Selection of Detectors for Final Measurement	4.44
4.5.5 Frequency Scan and Time Domain Scan – SWEEP Key	4.48
4.5.5.1 Stepped Scan in the Frequency Domain	4.48
4.5.5.2 Scan in the Time Domain	4.50
4.5.5.3 Display of Measurement Results	4.51
4.5.5.4 Entry of Scan Data	4.52
4.5.5.5 Running a Scan	4.58
4.5.6 Triggering the Scan – TRIG Key	4.59
4.5.7 Marker Functions – MKR Key	4.60
4.5.8 Change of Settings via Markers – MKR-> Key	4.63
4.5.9 Marker Functions – MKR FCTN Key	4.66
4.5.10 Selection and Setting of Traces – TRACE Key	4.68
4.5.10.1 Selection of Trace Function	4.68
4.6 Analyzer Mode	4.74
4.6.1 Frequency and Span Selection – FREQ Key	4.74
4.6.2 Setting the Frequency Span – SPAN Key	4.78
4.6.3 Level Display Setting and RF Input Configuration – AMPT Key	4.79
4.6.4 Setting the Bandwidths and Sweep Time – BW Key	4.83
4.6.4.1 Filter Types	4.88
4.6.4.2 List of Available Channel Filters	4.89
4.6.5 Sweep Settings – SWEEP Key	4.91
4.6.6 Triggering the Sweep – TRIG Key	4.93
4.6.7 Selection and Setting of Traces – TRACE Key	4.101

4.6.8 Selection of Trace Functions	4.101
4.6.8.1 Selection of Detector	4.108
4.6.8.2 Mathematical Functions for Traces	4.113
4.6.9 Recording the Correction Data – CAL Key	4.113
4.6.10 Markers and Delta Markers – MKR Key	4.115
4.6.10.1 Frequency Measurement with the Frequency Counter	4.118
4.6.11 Marker Functions – MKR FCTN Key	4.123
4.6.11.1 Activating the Markers	4.124
4.6.11.2 Measurement of Noise Density	4.124
4.6.11.3 Phase Noise Measurement	4.125
4.6.11.4 Measurement of the Filter or Signal Bandwidth	4.128
4.6.11.5 Measurement of a Peak List	4.129
4.6.11.6 AF Demodulation	4.131
4.6.11.7 Selecting the Trace	4.132
4.6.12 Change of Settings via Markers – MKR-> Key	4.132
4.6.13 Power Measurements – MEAS Key	4.139
4.6.13.1 Power Measurement in Time Domain	4.140
4.6.13.2 Channel and Adjacent-Channel Power Measurements	4.145
4.6.13.3 Setting the Channel Configuration	4.155
4.6.13.4 Measurement of Signal Amplitude Statistics	4.169
4.6.13.5 Measurement of Carrier/Noise Ratio C/N and C/No	4.178
4.6.13.6 Measurement of the AM Modulation Depth	4.180
4.6.13.7 Measurement of the Third Order Intercept (TOI)	4.181
4.6.13.8 Harmonic Measurement	4.184
4.6.13.9 Measuring Spurious Emissions	4.186
4.6.13.10 Spectrum Emission Mask Measurement	4.193
4.7 Basic Settings	4.208
4.7.1 Setup of Limit Lines and Display Lines – LINES Key	4.208
4.7.1.1 Selection of Limit Lines	4.209
4.7.1.2 Entry and Editing of Limit Lines	4.213
4.7.1.3 Display Lines	4.218
4.7.2 Configuration of Screen Display – DISP Key	4.220
4.7.3 Instrument Setup and Interface Configuration – SETUP Key	4.228
4.7.3.1 External Reference	4.231
4.7.3.2 Control of V-Networks (LISNs)	4.232
4.7.3.3 Preamplification and Preselection	4.233
4.7.3.4 Transducer	4.235
4.7.3.5 Programming the Interface Configuration and Time Setup	4.245
4.7.3.6 System Information	4.257
4.7.3.7 Service Menu	4.259
4.7.3.8 Firmware Update	4.262
4.7.3.9 External Noise Source	4.263

4.7.4 Saving and Recalling Data Sets – FILE Key	4.264
4.7.4.1 Overview	4.264
4.7.4.2 Operating Concept of File Managers	4.269
4.7.5 Measurement Documentation – HCOPY Key	4.273
4.7.5.1 Selecting Printer Colors	4.276
4.8 TV and RF Trigger – Option R&S FSP-B6	4.280
4.9 Tracking Generator – Option R&S FSP-B9	4.283
4.9.1 Tracking Generator Settings	4.283
4.9.2 Transmission Measurement	4.285
4.9.2.1 Calibration of Transmission Measurement	4.285
4.9.2.2 Normalization	4.287
4.9.3 Reflection Measurement	4.290
4.9.3.1 Calibration of Reflection Measurement	4.291
4.9.4 Calibration Mechanism	4.291
4.9.5 Frequency-Converting Measurements	4.293
4.9.6 External Modulation of the Tracking Generator	4.294
4.9.7 Power Offset of the Tracking Generator	4.296
4.10 External Generator Control – Option R&S FSP-B10	4.297
4.10.1 External Generator Settings	4.298
4.10.2 Transmission Measurement	4.299
4.10.2.1 Calibration of Transmission Measurement	4.299
4.10.2.2 Normalization	4.301
4.10.3 Reflection Measurement	4.304
4.10.3.1 Calibration of Reflection Measurement	4.305
4.10.4 Calibration Mechanism	4.305
4.10.5 Frequency-Converting Measurements	4.307
4.10.6 Configuration of an External Generator	4.308
4.10.7 List of Generator Types Supported by the R&S ESCI	4.311
4.11 LAN Interface - Option R&S FSP-B16	4.316
4.11.1 NOVELL Networks	4.316
4.11.2 MICROSOFT Network	4.316
4.11.3 Remote Data Transfer with TCP/IP Services	4.316
4.12 RSIB Protocol	4.318
4.12.1 Remote Control via RSIB Protocol	4.318
4.12.1.1 Windows Environment	4.318
4.12.1.2 UNIX Environment	4.319
4.13 RSIB Interface Functions	4.320
4.13.1 Overview of Interface Functions	4.320
4.13.1.1 Variables ibsta, iberr, ibcntl	4.320
4.13.1.2 Description of Interface Functions	4.321

4.13.2 Programming via the RSIB Protocol	4.329
4.13.2.1 Visual Basic	4.329
4.13.2.2 Visual Basic for Applications (Winword and Excel)	4.332
4.13.2.3 C / C++	4.333

4.1 Introduction

All functions of the R&S ESCI and their application are explained in detail in this chapter. The sequence of the described menu groups depends on the procedure selected for the configuration and start of a measurement:

1. Resetting the instrument
 - [“R&S ESCI Initial Configuration – PRESET Key” on page 4.6](#)
2. Setting the mode
 - [“Mode Selection – Hotkey Bar” on page 4.9](#)
 - [“Return to Manual Operation – LOCAL Menu” on page 4.10](#)
3. Setting the measurement parameters in receiver mode
 - [“Receiver Mode” on page 4.11](#)
4. Setting the measurement parameters in analyzer mode
 - [“Analyzer Mode” on page 4.74](#)
5. Basic functions for general settings, printout and data management
 - [“Setup of Limit Lines and Display Lines – LINES Key” on page 4.208](#)
 - [“Configuration of Screen Display – DISP Key” on page 4.220](#)
 - [“Instrument Setup and Interface Configuration – SETUP Key” on page 4.228](#)
 - [“Saving and Recalling Data Sets – FILE Key” on page 4.264](#)
 - [“Measurement Documentation – HCOPY Key” on page 4.273](#)
6. Additional and optional functions
 - [“External Generator Control – Option R&S FSP-B10” on page 4.297](#)
 - [“LAN Interface - Option R&S FSP-B16” on page 4.316](#)

The operating concept is described in the Quick Start Guide, chapter 4, “Basic Operation”.

The remote commands (if any) are indicated for each softkey. A detailed description of the associated remote commands is given in chapter [“Remote Control – Description of Commands”](#).

4.2 R&S ESCI Initial Configuration – PRESET Key

PRESET Using the *PRESET* key, the R&S ESCI can be set to a predefined initial state.



The settings are selected in a way that the RF input is always protected against overload, provided that the applied signal levels are in the allowed range for the instrument.

The initial instrument state set by the *PRESET* key can be adapted to arbitrary applications using the STARTUP RECALL function. With this function the STARTUP RECALL data set is loaded upon pressing the *PRESET* key. For further information refer to section [“Saving and Recalling Data Sets – FILE Key”](#) on page 4.264.

Two predefined initial states can be selected in the *SETUP* side menu. For details on the preset mode refer to section [“Instrument Setup and Interface Configuration – SETUP Key”](#), [“PRESET RECEIVER”](#) and [“PRESET ANALYZER”](#) on page 4.263.

Pressing the *PRESET* key causes the R&S ESCI to enter its initial state according to one of the following tables:

R&S ESCI Initial Configuration – PRESET Key

Table 4-4 RECEIVER SETUP of R&S ESCI

Parameter	Settings
Mode	Mixed (Bargraph in screen A und Spectrum in screen B)
Center frequency	100 MHz
Center frequency step size	AUTO COARSE
Span	5 MHz
RF attenuation	auto (10 dB minimum)
Reference level	87 dB μ V (-20 dBm)
Level range	100 dB log
Level unit	dB μ V
Sweep time	auto (2,5 ms)
Resolution bandwidth	Bargraph 120 kHz / 6 dB, Analyzer auto (100 kHz / 3 dB)
Video bandwidth	Bargraph 1 MHz, Analyzer auto (300 kHz)
FFT filters	off
Span / RBW	50
RBW / VBW	Analyzer 0,33
Sweep	cont
Trigger	free run
Trace 1	clr write, autopeak
Trace 2/3	blank
Detector	Bargraph Average
Trace math	off
Frequency offset	0 Hz
Reference level offset	0 dB
Reference level position	100 %
Grid	abs
Cal correction	on
Noise source	off
Input	RF, AC-coupled
Display	Split screen
Tracking generator (only with option R&S FSP-B9)	off
External generator 1/2 (only with option R&S FSP-B10)	off
Preamplifier	off
Preselector	on

R&S ESCI Initial Configuration – PRESET Key

Table 4-5 ANALYZER SETUP of R&S ESCI

Parameter	Settings
Mode	Spectrum
Center frequency	1,5 GHz / 3,5 GHz for R&S ESCI-3/-7
Center frequency step size	0.1 × center frequency
Span	3 GHz / 7 GHz (R&S ESCI-3/-7)
RF attenuation	auto (10 dB)
Reference level	-20 dBm
Level range	100 dB log
Level unit	dBm
Sweep time	auto
Resolution bandwidth	auto (3 MHz)
Video bandwidth	auto (10 MHz)
FFT filters	off
Span / RBW	50
RBW / VBW	0,33
Sweep	cont
Trigger	free run
Trace 1	clr write
Trace 2/3	blank
Detector	auto peak
Trace math	off
Frequency offset	0 Hz
Reference level offset	0 dB
Reference level position	100 %
Grid	abs
Cal correction	on
Noise source	off
Input	RF, AC-coupled
Display	Full screen, active screen A
Tracking generator (only with option R&S FSP-B9)	off
External generator 1/2 (only with option R&S FSP-B10)	off
Preamplifier	off
Preselector	off

4.3 Mode Selection – Hotkey Bar

For fast mode selection the R&S ESCI has keys located under the measurement screen, the so-called hotkeys. These hotkeys are displayed depending on the options installed on the instrument. According to the selected mode, the corresponding softkey menus are displayed (on the right side of the measurement screen).

In this section, only the hotkeys provided by the basic model are described. For information on the other hotkeys refer to the corresponding option descriptions.



Fig. 4.1 Hotkey bar of the basic model

- SPECTRUM** The *SPECTRUM* hotkey sets R&S ESCI to analyzer mode. For details on the softkey menus refer to section [“Analyzer Mode” on page 4.74](#).
- Remote command: INST:SEL SAN
 INST:NSEL 1
- RECEIVER** The *RECEIVER* hotkey sets the R&S ESCI in the test receiver mode.
- Remote command: INST:SEL REC
 INST:NSEL 6
- MIXED** The *MIXED* hotkey sets the R&S ESCI in a combination of test receiver and analyzer mode. The display is set to split screen.
- Remote command: INST:CONF:MIX ON
 INST:CONF1 REC
- SCREEN A /
SCREEN B** With the *SCREEN A / SCREEN B* hotkey two different settings can be selected on the R&S ESCI in the FULL SCREEN display mode.
- In the SPLIT SCREEN display mode the key switches between active diagram A and B.
- The key designation indicates the diagram which has been activated by means of the key.
- The currently active window is marked by **A** or **B** on the right of the diagram.
- Remote command: DISP:WIND<1|2>:SEL A

4.4 Return to Manual Operation – LOCAL Menu

LOCAL

The *LOCAL* menu is displayed on switching the instrument to remote control mode.

At the same time, the hotkey bar is blanked out and all keys are disabled except the *PRESET* key.

The *LOCAL* softkey and the *DISPLAY UPDATE ON/OFF* softkey are displayed.

Depending on the setting of the *DISPLAY UPDATE ON/OFF* softkey, the diagrams, traces and display fields are displayed or hidden. For further details on the *DISPLAY UPDATE ON/OFF* softkey refer to [Instrument Setup and Interface Configuration – SETUP Key](#).

The *LOCAL* key switches the instrument from remote to manual operation, with the assumption that the remote controller has not previously set the LOCAL LOCKOUT function.

A change in the control mode consists of:

- **Enabling the Front Panel Keys**

Returning to manual operation enables all inactive keys and turns on the hotkey bar. The softkey menu which is displayed is the main menu of the current mode.

- **Inserting the measurement diagrams**

The blanked diagrams, traces and display fields are inserted.

- **Generating the message OPERATION COMPLETE**

If, at the time of pressing the *LOCAL* softkey, the synchronization mechanism via *OPC, *OPC? or *WAI is active, the currently running measurement procedure is aborted and synchronization is achieved by setting the corresponding bits in the registers of the status reporting system.

- **Setting Bit 6 (User Request) of the Event Status Register**

With a corresponding configuration of the status reporting system, this bit immediately causes the generation of a service request (SRQ) which is used to inform the control software that the user wishes to return to front-panel control. This information can be used, e.g., to interrupt the control program so that the user can make necessary manual corrections to instrument settings. This bit is set each time the *LOCAL* softkey is pressed.



If the LOCAL LOCKOUT function is active in the remote control mode, the front-panel *PRESET* key is also disabled. The LOCAL LOCKOUT state is left as soon as the process controller de-activates the REN line or the GPIB cable is disconnected from the instrument.

4.5 Receiver Mode

RECEIVER

The receiver mode is selected using the *RECEIVER* hotkey (see also section “[Mode Selection – Hotkey Bar](#)” on page 4.9)

The mode is selected with the *RECEIVER* hotkey for displaying both subscreens or with the *MIXED* hotkey for displaying one subscreen as the receiver. The *RECEIVER* variant is described here. The description applies correspondingly to *MIXED* (see also section “[Mode Selection – Hotkey Bar](#)” on page 4.9).

RECEIVER FREQUENCY	
ADD TO PEAK LIST	
CONTINUOUS BARGRAPH	
SINGLE BARGRAPH	
DETECTOR ↓	MAX PEAK
	MIN PEAK
	QUASIPeAK
	AVERAGE
	CISPR AVERAGE
	RMS
	CISPR RMS
	CISPR RBW UNCOUPLED
MEAS TIME	
DEMOD ↓	DEMOD ON OFF
	AM FM
	SQUELCH
THRESHOLD SCAN ↓	THRESHOLD ON OFF
	EDIT PEAK LIST ↓
	NO OF PEAKS
	NB/BB DISCR
	MARGIN
	FINAL MEAS TIME
	AUTOMATIC FINAL
	INTER ACTIVE
	RUN SCAN
	Side menu
	ESH2-Z5 ESH3-Z5 ENV 4200 ENV 216 OFF
	PRESCAN PHASES FINAL PHASES ↓
	RUN SCAN

FINAL MEAS↵	PEAK SEARCH
	EDIT PEAK LIST↵
	NO OF PEAKS
	PEAKS SUBRANGES
	MARGIN
	FINAL MEAS TIME
	AUTOMATIC FINAL
	INTER ACTIVE
	RUN FINAL MEAS↵
	Side menu
	ESH2-Z5 ESH3-Z5 ENV 4200 ENV 216 OFF
	PRESCAN PHASES FINAL PHASES↵
	RUN FINAL MEAS↵
RUN PRE-SCAN+FINAL	HOLD SCAN
	STOP SCAN
RUN SCAN	HOLD SCAN
	STOP SCAN
Side menu	
RECEIVER FREQUENCY	
ADD TO PEAK LIST	
CONTINUOUS BARGRAPH	
SINGLE BARGRAPH	

The *RECEIVER* hotkey selects the receiver mode (RFI reception) and activates the menu for setting the receiver parameters.

For description of the softkeys see the following menus:

<i>RECEIVER FREQUENCY</i>	“Operation on a Discrete Frequency – <i>FREQ</i> Key” on page 4.14
<i>ADD TO PEAK LIST</i>	“Selection of the Measurement Function – <i>MEAS</i> Key” on page 4.23
<i>DETECTOR</i>	“Selecting the Detector” on page 4.26
<i>MEAS TIME</i>	“Setting the Measurement Time” on page 4.28
<i>DEMOD</i>	“AF Demodulators” on page 4.30
<i>THRESHOLD SCAN</i>	“Automatic Final Measurement with Threshold Scan” on page 4.33
<i>FINAL MEAS</i>	“Data Reduction and Peak List” on page 4.31
<i>RUN PRE SCAN+FINAL</i>	“Running a Scan” on page 4.58
<i>RUN SCAN</i>	“Running a Scan” on page 4.58
Side menu	
<i>CONTINUOUS BARGRAPH</i>	“Selection of the Measurement Function – <i>MEAS</i> Key” on page 4.23
<i>SINGLE BARGRAPH</i>	“Selection of the Measurement Function – <i>MEAS</i> Key” on page 4.23

Remote command: `INST REC`

In the receiver mode the R&S ESCI measures the level at the set frequency with a selected bandwidth and measurement time (see also “*RES BW*” on page 4.19 and “*MEAS TIME*” on page 4.29). Signal weighting is by means of detectors (see also “*DETECTOR*” on page 4.27).

The functions for data reduction and the control of line impedance simulating network are available in the *THRESHOLD SCAN* and *FINAL MEAS* submenus.

A frequency scan can be performed after setting the start and stop frequency and the step width. The scan subranges can be defined in a table (*DEFINE SCAN* softkey).

The scan is started with the *RUN SCAN* softkey. In operating mode *RECEIVER*, the *RECEIVER* hotkey directly opens the *RECEIVER* menu.

The R&S ESCI is fitted with a preselection with switchable preselection. Preselection is always switched on in receiver mode.

4.5.1 Operation on a Discrete Frequency – **FREQ** Key

FREQ

The *FREQ* key opens the *FREQUENCY* menu for setting the receive frequency in manual operation and the frequency axis for scan display.

RECEIVER FREQUENCY	
STEPSIZE↓	AUTO COARSE
	AUTO FINE
	STEPSIZE MANUAL
	STEPSIZE = FREQ
START	
STOP	
RUN PRE-SCAN+FINAL	
RUN SCAN	

RECEIVER FREQUENCY

The *RECEIVER FREQUENCY* softkey activates the entry field of the receiver frequency.

The tuning frequency has to be set to at least twice the IF bandwidth.

When the tuning frequency is lower than twice the IF bandwidth, the IF bandwidth is automatically reduced so that this condition is met again.

If the frequency is increased again, the original IF bandwidth is restored (memory function). The memory is cleared when the IF bandwidth is manually changed.

The resolution of the receive frequency is always 0.1 Hz.

Range: $9 \text{ kHz} \leq f_{\text{rec}} \leq f_{\text{max}}$

This softkey is also available in the *RECEIVER / MEAS* menu.

Remote command: `FREQ:CENT 300 MHz`

STEPSIZE

The *STEPSIZE* softkey opens a submenu for setting the step size of the receive frequency. The step size can be coupled to the set frequency or be manually set to a fixed value. The softkeys of the submenu are mutually exclusive selection switches. Only one switch can be activated at any one time.

AUTO COARSE

If the *AUTO COARSE* softkey is activated, the receive frequency is set in coarse steps. The 4th digit of the selected frequency is varied.

Remote command: `--`

AUTO FINE

If the *AUTO FINE* softkey is activated, the receive frequency is set in fine steps. The 7th digit of the selected frequency is varied.

Remote command: `--`

STEPSIZE MANUAL

The *STEPSIZE MANUAL* softkey activates the entry window for the input of a fixed step size.

Remote command: `FREQ:CENT:STEP 50 kHz`

- STEPSIZE =
FREQ** The *STEPSIZE = FREQ* softkey sets the step size to a value equal to the receive frequency.
- This function is especially useful during measurements of the signal harmonic content, because, when entering the receiver frequency, the receiver frequency of another harmonic is selected with each stroke of the *STEP* key.
- Remote command: --
- START** The *START* softkey opens a window where the start frequency of the scan diagram can be entered.
- The permissible value range for the start frequency is:
- $$f_{\min} \leq f_{\text{start}} \leq f_{\max} - 10 \text{ Hz}$$
- f_{start} : start frequency
 f_{\max} : maximum frequency
- Remote command: :FREQ:STAR 20 MHz
- STOP** The *STOP* softkey opens a window where the stop frequency of the scan diagram can be entered.
- The permissible value range for the stop frequency is:
- $$f_{\min} + 10 \text{ Hz} \leq f_{\text{stop}} \leq f_{\max}$$
- f_{stop} : stop frequency
 f_{\max} : maximum frequency
- Remote command: :FREQ:STOP 2000 MHz
- RUN PRE-
SCAN+FINAL** For details refer to the *SWEEP* menu, [“RUN PRE-SCAN+FINAL” on page 4.58.](#)
- RUN SCAN** For details refer to the *SWEEP* menu, [“RUN SCAN” on page 4.58.](#)

4.5.2 Level Display and RF Input Configuration – AMPT Key

The *AMPT* key is used to set the input attenuation, the [Preamplifier](#), the auto range function and the [Display Unit](#).

In addition, the level display range for the scan can be set.

AMPT

RF ATTEN MANUAL	
PREAMP ON OFF	
10 DB MIN ON OFF	
AUTO RANGE ON OFF	
AUTOPREAMP ON OFF	
UNIT↓	dBμV / dBm / dBμA / dBpW / dBpT
RF INPUT AC DC	
GRID RANGE LOG MANUAL	
GRID MIN LEVEL	

*) LN PREAMP ON OFF is only available with option R&S ESCI-B24

RF ATTEN MANUAL

The *RF ATTEN MANUAL* softkey activates the attenuation entry field.

The attenuation can be set between 0 and 75 dB in 5 dB steps. Other entries are rounded up to the next higher integer.



To protect the input mixer against inadvertent overload, 0 dB can only be switched on when the *10 dB MIN* softkey is switched off.

Remote command: `INP:ATT 40 DB`

Preamplifier

The R&S ESCI is provided with a switchable preamplifier of 20 dB gain covering the whole frequency range of the instrument.

Switching on the preamplifier reduces the total mark figure of the R&S ESCI and thus improves the sensitivity.

The disadvantage of a poorer large-signal immunity (intermodulation) is reduced by the connected preselector. The signal level of the subsequent mixer is 20 dB higher so that the maximum input level is reduced by the gain of the preamplifier. The total noise figure of R&S ESCI is reduced from approx. 18 dB to approx. 10 dB when a preamplifier is used.

The use of the preamplifier is recommended when measurements with a maximum sensitivity are to be performed. On the other hand, if the measurement should be performed at maximum dynamic range, the preamplifier should be switched off.

The gain of the preamplifier is automatically considered in the level display. The preamplifier follows the preselection filters so that the risk of overdriving by strong out-of-band signals is reduced to a minimum.

**PREAMP ON
OFF**

The *PREAMP ON/OFF* softkey switches the preamplifier on and off.
Default value is OFF.

Remote command: `INP:GAIN:STAT ON | OFF`

**10 DB MIN
ON | OFF**

The *10 DB MIN* softkey determines whether the 10 dB setting of the attenuator may be used in the manual or automatic setting of the attenuator.

10 DB MIN ON is the default value, i.e. an RF attenuation of at least 10 dB is always set on the R&S ESCI to protect the input mixer.

An attenuation of 0 dB cannot be set manually either. This avoids 0 dB being switched on inadvertently, particularly when DUTs with high RFI voltage are measured.

Remote command: `INP:ATT:PROT ON | OFF`

**AUTO RANGE
ON | OFF**

The *AUTO RANGE ON/OFF softkey* switches the autorange function on and off.

ON The attenuation is automatically set so that a good S/N ratio is obtained without the receiver stages being overdriven.

OFF The attenuation is set manually.



Depending on the characteristics of the RF signal, the receiver may not utilize the maximum possible dynamic range. Measurement results are still valid, however, because it is ensured that performing measurements does not result in an overload.

Remote command: `INP:ATT:AUTO ON | OFF`

**AUTOPREAMP
ON | OFF**

The *AUTOPREAMP ON/OFF* softkey switches the auto preamp function and or off.

ON The preamplifier is considered in the autorange procedure. The preamplifier is cut in when the RF attenuation is reduced to the minimum settable value.

OFF The preamplifier is not considered in the autorange procedure.

Remote command: `INP:GAIN:AUTO ON | OFF`

Display Unit**UNIT**

UNIT	dB μ V
	dBm
	dB μ A
	dBpW
	dBpT

The *UNIT* softkey opens a submenu in which the desired units for the level axis can be selected: dB μ V, dBm, dB μ A, dBpW or dBpT. Default setting is dB μ V.

In general, a receiver measures the signal voltage at the RF input. The level display is calibrated in rms values of an unmodulated sinewave signal.

Via the known input resistance of $50\ \Omega$ a conversion can be made to other units. The units dBm, dB μ A, dBpW, and dBpT are directly convertible.

Remote command: `CALC:UNIT:POW DBM`

RF INPUT AC | DC

The *RF INPUT AC/DC* softkey switches between AC and DC coupling of the instrument input. The state of the input coupling is displayed with an enhancement label on the right side of the diagram.



State of input coupling Frequency

DC coupled 9 kHz to 3 GHz

AC coupled 1 MHz to 3 GHz

Measurements outside the valid frequency range are marked with the AC label in red.

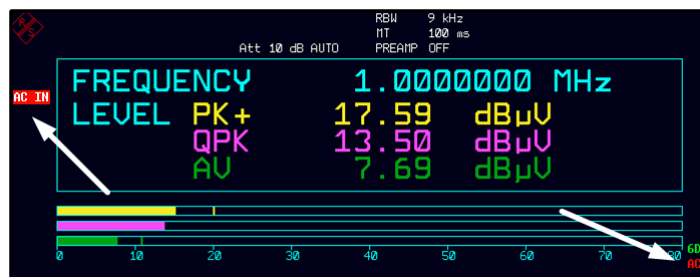

Remote command: `INP:COUP AC|DC`

GRID RANGE LOG MANUAL

The *GRID RANGE LOG MANUAL* softkey activates the entry of the level display range for the scan diagram.

The display ranges go from 10 to 200 dB in 10-dB steps. Invalid entries are rounded off to the nearest valid value.

Remote command: `DISP:WIND:TRAC:Y:SPAC LOG`
`DISP:WIND:TRAC:Y 120DB`

GRID MIN LEVEL

The *GRID MIN LEVEL* softkey activates the entry of the minimum level of the display range. Allowed values are:

$-200 \leq \text{GRID MIN LEVEL} \leq +200 \text{ dB} - \text{GRID RANGE}$

Remote command: `DISP:WIND:TRAC:Y:SPAC LOG`
`DISP:WIND:TRAC:Y:BOTT 0DBM`

4.5.3 Setting the IF Bandwidth – BW Key

R&S ESCI offers the IF bandwidths (3 dB bandwidths) from 10 Hz to 10 MHz available in steps of 1/3/10. With filter type EMI (6 dB) 200 Hz, 9 kHz, 120 kHz are available as 6 dB bandwidth and 1 MHz as impulse bandwidth.

The resolution bandwidths up to 120 kHz are implemented by digital Gaussian bandpass filters. Concerning the attenuation characteristic, the filters behave like analog filters, but their measurement speed is much higher than the measurement speed of comparable analog filters. This is due to the fact that the transient response can be compensated because the filters have an accurately defined behavior.

Bandwidths of 300 kHz and higher are implemented by decoupled LC filters. These filters contain 4 filter circuits.

BW

The *BW* key calls a menu for setting the resolution bandwidth (*RES BW*) for the receiver.



RES BW	
200 Hz	
9 kHz	
120 kHz	
1 MHz	
CISPR RBW UNCOUPLED	
FILTER TYPE ↓	NORMAL (3dB)
	EMI (6dB)
	CHANNEL
	RRC

RES BW

The *RES BW* softkey activates the manual entry mode for the resolution bandwidth.

For filter type NORMAL (3 dB), the bandwidth can be set from 10 Hz to 10 MHz in steps of 1/3/10. For filter type EMI (6 dB), the 6-dB bandwidth 200 Hz, 9 kHz, 120 kHz and 1 MHz can be set.

For numerical inputs, the values are always rounded up to the next valid bandwidth. For rotary knob or the *UP/DOWN* key entries, the bandwidth is adjusted in steps either upwards or downwards.

For the CHANNEL and RRC filter types, the bandwidth is selected from a list of available channel filters, which is included at the end of this section. The list can be scrolled with the  and  keys to select a filter (see section “List of Available Channel Filters” on page 4.21).

When the quasipeak detector is switched on, a fixed bandwidth is preset depending on the frequency. The coupling of the IF bandwidth to the frequency range with activated quasipeak detector can be cancelled using the *CISPR RBW UNCOUPLED* softkey (see below). The same is true for the CISPR RMS and CISPR Average detectors.

The bandwidth is limited by the set receive frequency:

$$\text{RES BW} \leq f_{\text{in}} / 2$$

Remote command: BAND 1 MHz

200 Hz

The *200 Hz* softkey sets the CISPR bandwidth 200 Hz.

Remote command: BAND 200 Hz

9 kHz

The *9 kHz* softkey sets the CISPR bandwidth 9 kHz.

Remote command: BAND 9 kHz

120 kHz

The *120 kHz* softkey sets the CISPR bandwidth 120 kHz.

Remote command: BAND 120 kHz

1 MHz

The *1 MHz* softkey sets the 6-dB bandwidth 1 MHz.

Remote command: BAND 1 MHz

CISPR RBW UNCOUPLED

The *CISPR RBW UNCOUPLED* softkey cancels the coupling of the IF bandwidth to the frequency range with the activated quasipeak, CISPR Average or CISPR RMS detector.

If the coupling is cancelled, any of the three CISPR bandwidths 200 Hz, 9 kHz, 120 kHz can be selected for a given frequency range.

Remote command: BAND:AUTO ON

FILTER TYPE

The *FILTER TYPE* softkey opens a list of available filter types. Gaussian bandpass filters of 3 dB and 6 dB bandwidth as well as particularly steep-edged channel filters for power measurements are available.

NORMAL (3dB)
EMI (6dB)
CHANNEL
RRC

- *NORMAL (3dB)*

The resolution bandwidths are implemented by Gaussian filters with a set 3 dB bandwidth. These bandwidths correspond to the noise bandwidth approximately. For bandwidths up to 100 kHz, digital bandpass filters are used.

Remote command: BAND:TYPE NOIS
BAND:TYPE NORM

- *EMI (6dB)*

The resolution bandwidths are implemented by Gaussian filters with the set 6 dB bandwidth and correspond approximately to the pulse bandwidth.

For bandwidths up to 120 kHz, digital bandpass filters are used.

Remote command: BAND:TYPE PULS

- *CHANNEL*

steep-edged channel filters

Remote command: `BAND:TYPE CFIL`

- *RRC*

Root Raised Cosine filters

Remote command: `BAND:TYPE RRC`

4.5.3.1 List of Available Channel Filters

The channel filters listed in the following table are available as resolution filters (soft-key *RES BW*) after activation with the softkey *FILTER TYPE*.

The channel filters ≥ 2.0 MHz are only available for instruments equipped with a model ≥ 3 of the IF FILTER module (see column *MODEL* in *HARDWARE INFO* table, *SETUP SYSTEM INFO* menu).



For filter type RRC (Root Raised Cosine) the indicated filter bandwidth describes the sampling rate of the filter.

For all other filters (CFILter) the filter bandwidth is the 3-dB bandwidth.

Filter Bandwidth		Filter Type	Application
100	Hz	CFILter	A0
200	Hz	CFILter	
300	Hz	CFILter	
500	Hz	CFILter	
1	kHz	CFILter	SSB
1.5	kHz	CFILter	
2	kHz	CFILter	
2.4	kHz	CFILter	
2.7	kHz	CFILter	
3	kHz	CFILter	
3.4	kHz	CFILter	
4	kHz	CFILter	DAB, Satellite
4.5	kHz	CFILter	
5	kHz	CFILter	
6	kHz	CFILter	ETSS300 113 (12.5 kHz channels)
8.5	kHz	CFILter	
9	kHz	CFILter	

Filter Bandwidth		Filter Type	Application
10	kHz	CFILter	CDMAone ETTS300 113 (20 kHz channels) ETTS300 113 (25 kHz channels) TETRA PDC IS 136 CDPD, CDMAone
12.5	kHz	CFILter	
14	kHz	CFILter	
15	kHz	CFILter	
16	kHz	CFILter	
18	kHz, $\alpha=0.35$	RRC	
20	kHz	CFILter	
21	kHz	CFILter	
24.3	kHz, $\alpha=0.35$	RRC	
25	kHz	CFILter	
30	kHz	CFILter	
50	kHz	CFILter	
100	kHz	CFILter	FM Radio PHS J.83 (8-VSB DVB, USA)
150	kHz	CFILter	
192	kHz	CFILter	
200	kHz	CFILter	
300	kHz	CFILter	
500	kHz	CFILter	
1.0	MHz	CFILter	CDMAone CDMAone DAB W-CDMA 3GPP W-CDMA NTT DOCoMo
1.2288	MHz	CFILter	
1.5	MHz	CFILter	
2.0*	MHz	CFILter	
3.0*	MHz	CFILter	
3.84	MHz, $\alpha=0.22^*$	RRC	
4.096	MHz, $\alpha=0.22^*$	RRC	
5.0*	MHz	CFILter	

*) requires IF filter model index ≥ 3

4.5.4 Selection of the Measurement Function – MEAS Key

The *MEAS* key opens the menu to select the detectors and set the measurement time for the receiver and the audio demodulator.

To reduce the amount of data in RFI voltage measurements, a list of subrange maxima (softkey *PEAK SEARCH*) can be generated from the scan results and an acceptance line (softkey *MARGIN*) may be defined in the *FINAL MEAS* submenu. A final measurement is performed only for frequencies with high RFI level.

The final measurement may be either automatic (softkey *AUTOMATIC FINAL*) or in interactive mode (softkey *INTERACTIVE*). Automatic control functions for line impedance stabilization networks (LISN) are available in the side menu of the *FINAL MEAS* submenu. The final measurement is started with the softkey *RUN FINAL MEAS*.

The *THRESHOLD SCAN* function is also used to reduce data. The scan is immediately interrupted when a limit violation is detected and the final measurement performed within a short time.

MEAS

Softkeys in the *MEAS* menu:

RECEIVER FREQUENCY		
ADD TO PEAK LIST		
DETECTOR↓	MAX PEAK	
	MIN PEAK	
	QUASIPeAK	
	AVERAGE	
	CISPR AVERAGE	
	RMS	
	CISPR RMS	
	CISPR RBW UNCOUPLED	
MEAS TIME		
DEMOD↓	DEMOD ON OFF	
	AM FM	
	SQUELCH	
THRESHOLD SCAN↓	THRESHOLD ON OFF	
	EDIT PEAK LIST↓	EDIT FREQUENCY
		INSERT
		DELETE
		SORT BY FREQUENCY
		SORT BY DELTALIMIT
		ASCII FILE EXPORT

		DECIM SEP
		PAGE UP
		PAGE DOWN
	NO OF PEAKS	
	NB/BB DISCR	
	MARGIN	
	FINAL MEAS TIME	
	AUTOMATIC FINAL	
	INTER ACTIVE	
	RUN SCAN	
	Side menu	
	ESH2-Z5 ESH3-Z5 ENV 4200 ENV 216 OFF	
	PRESCAN PHASES FINAL PHASES ↓	
	RUN SCAN	
FINAL MEAS ↓	PEAK SEARCH	
	EDIT PEAK LIST ↓	EDIT FREQUENCY
		INSERT
		DELETE
		SORT BY FREQUENCY
		SORT BY DELTALIMIT
		ASCII FILE EXPORT
		DECIM SEP
		PAGE UP
		PAGE DOWN
	NO OF PEAKS	
	PEAKS SUBRANGES	
	MARGIN	
	FINAL MEAS TIME	
	AUTOMATIC FINAL	
	INTER ACTIVE	
	RUN FINAL MEAS	RUN FINAL MEAS
		STOP FINAL MEAS
	Side menu	

	ESH2-Z5 ESH3-Z5 ENV 4200 ENV 216 OFF	
	PRESCAN PHASES FINAL PHASES ↓	PHASE N PHASE L1 PHASE L2 PHASE L3
		PE GROUNDED PE FLOATING
	RUN FINAL MEAS	
RUN PRE-SCAN+FINAL		
RUN SCAN		
Side menu		
RECEIVER FREQUENCY		
ADD TO PEAK LIST		
CONTINUOUS BARGRAPH		
SINGLE BARGRAPH		

RECEIVER FREQUENCY

The *RECEIVER FREQUENCY* softkey activates the entry field of the receiver frequency.

The tuning frequency has to be set to at least twice the IF bandwidth.

When the tuning frequency is lower than twice the IF bandwidth, the IF bandwidth is automatically reduced so that this condition is met again.

If the frequency is increased again, the original IF bandwidth is restored (memory function). The memory is cleared when the IF bandwidth is manually changed.

The resolution of the receive frequency is always 0.1 Hz.

Range: $9 \text{ kHz} \leq f_{\text{rec}} \leq f_{\text{max}}$

This softkey is also available in the RECEIVER/FREQ menu.

Remote command: `FREQ:CENT 300 MHz`

ADD TO PEAK LIST

The *ADD TO PEAK LIST* softkey adds the receiver frequency to the peak list (see also section [4.5.4.4 "Data Reduction and Peak List" on page 4.31](#)).

Remote command: `--`

CONTINUOUS BARGRAPH

The *CONTINUOUS BARGRAPH* softkey selects the continuous measurement mode.

Remote command: `INIT:CONT ON`

SINGLE BARGRAPH

Pressing the *SINGLE BARGRAPH* softkey triggers a single level measurement. The enhancement label SGL displayed at the screen edge indicates that the single-measurement mode is set.

Remote command: `INIT:CONT OFF`

4.5.4.1 Selecting the Detector

Six different detectors can be selected for weighting the receive signal.

- The max peak detector yields the largest sample values of the levels measured during the set measurement time.
- The min peak detector yields the smallest sample values of the levels measured during the set measurement time.
- The average detector yields the average level of the samples measured during the set measurement time.
- The CISPR average detector supplies a weighted average. When measuring the average according to CISPR 16-1, the maximum value of the linear average during the measurement time is displayed. The detector is used, for example, to measure pulsed sinusoidal signals with a low pulse frequency. It is calibrated with the rms value of an unmodulated sinusoidal signal. Averaging is with lowpass filters of the 2nd order (simulation of a mechanical instrument). The lowpass time constants and the IF bandwidths are fixed depending on the frequency. The main parameters are listed in the following table:

	Band A	Band B	Band C/D
Frequency range	< 150 kHz	150 kHz to 30 MHz	> 30 MHz
IF bandwidth	200 Hz	9 kHz	120 kHz
Time constant of instrument	160 ms	160 ms	100 ms

For frequencies above 1 GHz, the R&S ESCI uses the 120 kHz bandwidth of band C/D.

Coupling of the IF bandwidth to the frequency range with the CISPR average detector activated can be switched off by the *CISPR RBW UNCOUPLED* softkey.

- The rms detector yields the rms level of the samples measured. The integration time corresponds to the set measurement time.
- The CISPR rms detector supplies a weighted average. When measuring the average according to CISPR 16-1, the maximum value of the linear average during the measurement time is displayed. The detector is used, for example, to measure pulsed sinusoidal signals with a low pulse frequency. It is calibrated with the rms value of an unmodulated sinusoidal signal. Averaging is with lowpass filters of the 2nd order (simulation of a mechanical instrument). The lowpass time constants and the IF bandwidths are fixed depending on the frequency. The main parameters are listed in the following table:

	Band A	Band B	Band C/D	Band E
Frequency range	< 150 kHz	150 kHz to 30 MHz	30 MHz to 1 GHz	> 1 GHz
IF bandwidth	200 Hz	9 kHz	120 kHz	1 MHz
Time constant of instrument	160 ms	160 ms	100 ms	100 ms
Corner frequency	10 Hz	100 Hz	100 Hz	1 kHz

- The quasipeak detector yields the maximum detected value weighted to CISPR 16. Depending on the set frequency, the R&S ESCI automatically selects the detectors and IF bandwidths defined for bands A, B and C/D listed in the following table:

	Band A	Band B	Band C/D
Frequency range	< 150 kHz	150 kHz to 30 MHz	> 30 MHz
IF bandwidth	200 Hz	9 kHz	120 kHz
Charge time constant	45 ms	1 ms	1 ms
Discharge time constant	500 ms	160 ms	550 ms
Time constant of instrument	160 ms	160 ms	100 ms

For frequencies above 1 GHz, the R&S ESCI uses the 120 kHz bandwidth of band C/D.

The coupling of the IF bandwidth to the frequency range with activated quasipeak detector can be cancelled using the *CISPR RBW UNCOUPLED* softkey.

- The input signal of R&S ESCI can be displayed weighted by three detectors simultaneously.

Multiple detection is important in EMI measurements since, for example, civil standards specify limits for both the quasipeak and the average value. Thanks to the multiple use of detectors, only one test run is needed. The peak detector can be combined with any other detector since it is the fastest detector and therefore ideal for overview measurements.

DETECTOR

The *DETECTOR* softkey opens a submenu to select the detector and combinations of detectors.

The detector type is set for the bargraph measurement and is displayed after the selection. Up to three detectors can be displayed simultaneously.

MAX PEAK
MIN PEAK
QUASPEAK
AVERAGE
CISPR AVERAGE
RMS
CISPR RMS
CISPR RBW UNCOUPLED

A maximum of three detectors can be switched on simultaneously.

This softkey is also available in the RECEIVER menu.

MAX PEAK The *MAX PEAK* softkey activates the max peak detector.

Remote command: DET:REC POS

MIN PEAK	The <i>MIN PEAK</i> softkey activates the min peak detector. Remote command: DET:REC NEG
QUASIPeAK	The <i>QUASIPeAK</i> softkey selects the quasipeak detector. The IF bandwidth is adapted as a function of the frequency range. The coupling of the IF bandwidth to the frequency range can be cancelled using the softkey <i>CISPR RBW UNCOUPLED</i> . Remote command: DET:REC QPE
AVERAGE	The <i>AVERAGE</i> softkey activates the average detector. Remote command: DET:REC AVER
CISPR AVERAGE	The <i>CISPR AVERAGE</i> softkey activates the weighting average detector according to CISPR 16-1. The IF bandwidth is automatically set to the required value according to the receiving frequency. This coupling can be cancelled by the softkey <i>CISPR RBW UNCOUPLED</i> . Remote command: DET:REC CAV
RMS	The <i>RMS</i> softkey activates the rms detector. Remote command: DET:REC RMS
CISPR RMS	The <i>CISPR RMS</i> softkey activates the weighting rms detector according to CISPR 16-1. The IF bandwidth is automatically set to the required value according to the receiving frequency. This coupling can be cancelled by the <i>CISPR RBW UNCOUPLED</i> softkey. Remote command: DET:REC CRMS
CISPR RBW UNCOUPLED	The <i>CISPR RBW UNCOUPLED</i> softkey cancels the coupling of the IF bandwidth to the frequency range with activated quasipeak or CISPR average and CISPR RMS detector. Remote command: BAND:AUTO OFF

4.5.4.2 Setting the Measurement Time

The measurement time can be set with a 2-digit resolution in the range 33 μ s to 100 s.

The measurement time is the time during which R&S ESCI measures the input signal and forms a measurement result weighted by the selected detector. The measurement time does not include settling times of the synthesizer and the IF filter. R&S ESCI automatically waits until transients are over.

When the quasipeak detector is used, the minimum measurement time is 500 μ s. CISPR average detector and CISPR RMS detector behave like an average or an RMS detector with measurement times below 20 ms. With the average, RMS or min/max peak detector, the smallest settable measurement time depends on the bandwidth.

Bandwidth	Shortest measurement time AV, RMS	Shortest measurement time PK+, PK-
≤ 30 Hz	1 sec	10 msec
100 Hz	100 msec	1 msec
200 Hz ... 300 Hz	50 msec	1 msec
1 kHz ... 3 KHz	10 msec	0,1 msec
9 kHz ... 30 kHz	1 msec	0,1 msec
≥ 100 kHz	1 msec	33 µsec

MEAS TIME

The *MEAS TIME* softkey activates the entry field for the measurement time.

This softkey is also available in the RECEIVER menu.

Remote command: `SWE:TIME 100ms`

Effect of measurement time with different weighting modes:

- MIN/MAX PEAK measurement:

With peak weighting selected, the maximum or minimum level during the selected measurement time is displayed. The peak detector is reset at the beginning of each measurement. At the end of the measurement time the maximum or minimum level occurred during the measurement time is displayed. Since the peak detector of R&S ESCI is a digital detector, discharging is irrelevant even with long measurement times.

Unmodulated signals can be measured with the shortest possible measurement time. When pulses are measured, the selected measurement time must be long enough for at least one pulse to occur during the measurement time.

- Average measurement:

With average detection selected, the video voltage (envelope of IF signal) is averaged during the measurement time. Averaging is digital, i.e. the digitized values of the video voltage are summed up and divided by the number of samples at the end of the measurement time. This corresponds to a filtering with a rectangular window in the time domain and a filtering with $\sin x/x$ characteristic in the frequency domain. With unmodulated signals the shortest possible measurement time can be selected. With modulated signals the measurement time is determined by the lowest modulation frequency to be averaged. With pulse signals, the selected measurement time should be long enough for sufficient number of pulses (>10) to occur in the measurement window for averaging.

- CISPR average and CISPR rms measurement:

With a CISPR average or a CISPR rms measurement, the maximum value of the weighted signal during the measurement time is displayed. The relatively long time constants used with CISPR average and CISPR rms detectors result in long measurement times in order to obtain a correct measurement result. If unknown signals are measured, the measurement time should be at least one second so that pulses down to a frequency of 5 Hz are correctly weighted.

After a frequency change or a modification of the attenuation, the R&S ESCI waits until the lowpass has settled before the measurement time starts. The measurement time is selected depending on the IF bandwidth and the characteristics of the signal to be measured. Unmodulated sinusoidal signals as well as signals with high modulation frequency can be measured within a short time. Slowly fluctuating signals or pulse signals require longer measurement times.

With measurement times shorter than 20 ms the detector weighting changes to average or RMS.

- RMS measurement:

With RMS weighting the same applies to the measurement time as with the average measurement.

- Quasipeak measurement:

With quasipeak measurements, the maximum value of the weighted signal during the measurement time is displayed. The relatively long time constants used with quasipeak detectors entail long measurement times to obtain correct results. With unknown signals the measurement time should be at least 1 s. This ensures correct weighting of pulses down to a pulse frequency of 5 Hz.

After internal switching, R&S ESCI waits until the measurement result has stabilized before it starts the actual measurement. Since the level does not change during a frequency scan, known signals (e.g. broadband RFI) can be correctly measured with a much shorter measurement time.

- Measurement with several detectors:

If several detectors are used simultaneously, a measurement time suiting the slowest detector should be selected to obtain correct results for all detectors. It is therefore recommended to set a measurement time that matches the average detector when the peak and average detectors are used.

4.5.4.3 AF Demodulators

The R&S ESCI provides demodulators for AM and FM signals. With these demodulators selected, a displayed signal can be monitored using the internal loudspeaker or external headphones.

DEMOM

The *DEMOM* softkey calls a submenu in which the desired type of demodulation can be switched on.

DEMOM ON OFF
AM FM
SQUELCH

The volume for loudspeaker and headphones is set by means of control knob on the front panel. The volume can also be remote-controlled (remote command `SYST: SPE:VOL 0.7`).

A squelch function enables the input of a level threshold below which the audible AF is cut off.

This softkey is also available in the RECEIVER menu.

DEM
ON | OFF

The *DEM* ON | OFF softkey switches demodulation on/off.

Remote command: `DEM OFF`
 (`DEModulation ON` automatically switched on with
 `DEM AM | FM`)

AM | FM

The *AM* and *FM* softkeys can be activated one at a time. They are used to set the desired demodulation type, FM or AM.

Remote command: `DEM AM`

SQUELCH

The *SQUELCH* softkey enables the input of a level threshold below which the audible AF is cut off. The squelch function is associated with the internal trigger function (*TRIGGER* menu), which will be switched on automatically with the squelch. Squelch level and trigger level do have the same value.

The default setting for the squelch is off.

Remote command: `SENS:DEM:SQU ON`
 `SENS:DEM:SQU:LEV 80 PCT`

4.5.4.4 Data Reduction and Peak List

EMI measurements may involve much time because the time constants prescribed by the standard for the quasipeak weighting require transients which lead to long measurement times per each value. In addition, the standards stipulate procedures for finding local EMI maxima such as shifting the absorbing clamp, variation of the test antenna height and rotating the DUT. Measuring with quasipeak weighting at each frequency and for each setting of the test configuration would lead to unacceptably long measurement times. For this reason, R&S has developed a method which reduces the time-consuming measurements to a minimum with an optimum reliability of detection.

Data Reduction using the Subrange Maximum

The interference spectrum is first pre-analyzed in a fast prescan to optimize the duration of the measurement. Data reduction follows so that the time-consuming final measurement is performed at only some important frequencies:

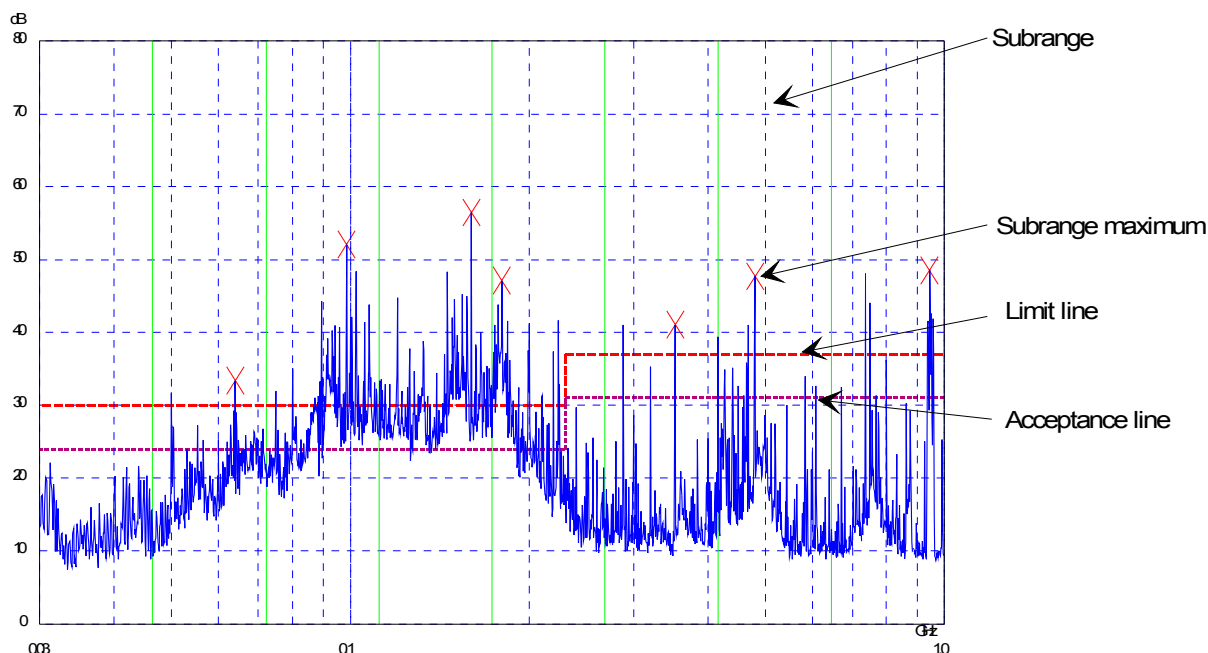

Fig. 4.14 Dividing the spectrum into eight subranges

Data reduction is of crucial importance. It is initiated by pressing a key after the prescan and then automatically. Data reduction is used to select frequencies with a very high interference level. Several data reduction methods are used:

- Acceptance analysis, i.e. the interference spectrum is further analyzed at frequencies with levels above a line parallel to a limit line.
- Generating subrange maxima, i.e. the interference spectrum is further analyzed at frequencies with the highest interference level of a frequency subrange (search method SUBRANGES).
- Determination of a specific number of peak values relative to the limit lines with the level values being independent of their frequency spectral distribution (search method PEAKS).

For generation of subrange maxima, the whole frequency range is divided into equidistant subranges. A subrange maximum is determined for each subrange (search method SUBRANGES).

Determining the level maxima irrespective of their distribution in the frequency spectrum (search mode PEAKS) is suitable for measurement regulations that demand determination of the relatively highest level irrespective of the distribution in the measured frequency range, e.g. FCC.

If the prescan is performed in parallel with several detectors, typically with peak value and average value, the maxima are determined separately for the two detectors so that the distribution of narrowband and wideband sources of interference can be taken into account. For example, the frequency of the maximum determined with the average detector can be used for the final measurement performed with this detector and the frequency found in the prescan carried out with the peak detector is taken for the final measurement using the quasipeak detector.

Consideration of the limit lines ensures that the final measurement is not performed at frequencies at which the inference level is far below the limit value. The margin between the acceptance line and the limit line can be selected by the user in dB as the *MARGIN*. Each limit line is allocated to a trace, i.e. different limit lines are taken for the different detectors.

Two values should therefore be defined for this purpose:

- the number of subranges or highest level values (*NO OF PEAKS* in the range from 1 to 500; default value: 25)
- the acceptance margin (*MARGIN*; default value: 6 dB). It is valid for all limit lines.

As an alternative method, it is possible to preset a list of frequencies at which the final measurements are performed. A typical application is, for example, the statistical analysis of several units.

The peak list can be either edited manually or can be filled with desired values by adopting the marker values.

If no limit lines are activated, the measurement procedure is as if all measured values would exceed the limit line.

4.5.4.5 Automatic Final Measurement with Threshold Scan

The interference spectrum is first pre-analyzed in a fast prescan to optimize the duration of the measurement. If the measured level exceeds a limit line, or violates a margin defined for this line, the time-consuming final measurement is performed. The final measurement is, therefore, carried out only for a reduced number of frequencies of interest. For this measurement, each scan trace to be taken into account has to be assigned a limit line, and the limit line and the limit check function have to be activated in the *LIMIT LINE* menu.

The prescan is interrupted immediately for each final measurement to be performed, i.e. the final measurement immediately follows the prescan measurement. In the case of drifting or fluctuating interferers, this increases the probability that the signal of interest will be reliably detected in the final measurement.

If the narrowband/broadband discrimination function is activated (*NB/BB DISCR* softkey), the R&S ESCI automatically selects the detector to use in the final measurement. To this end, the R&S ESCI compares the positive and the negative peak value obtained in the prescan. If the difference between the two values exceeds a user-selected threshold, a broadband interferer is assumed, and the quasipeak detector is used in the final measurement. If the difference falls below this threshold, a narrowband interferer is assumed, and the average detector is used in the final measurement. (The R&S ESCI automatically determines the positive and the negative peak value during the prescan.)

The value obtained in the final measurement is added to the peak list, where it replaces the result of the prescan. With *NO OF PEAKS*, the maximum number of peak values to be included in the list can be defined. If this number is attained, the prescan will be continued, but no further final measurements will be performed.

THRESHOLD SCAN

The *THRESHOLD SCAN* submenu is called from the *RECEIVER* main menu:

THRESHOLD ON OFF	
EDIT PEAK LIST ↓	EDIT FREQUENCY
	INSERT
	DELETE
	SORT BY FREQUENCY
	SORT BY DELTALIMIT
	ASCII FILE EXPORT

	DECIM SEP
	PAGE UP
	PAGE DOWN
NO OF PEAKS	
NB/BB DISCR	
MARGIN	
FINAL MEAS TIME	
AUTOMATIC FINAL	
INTER ACTIVE	
RUN SCAN	
Side menu	
ESH2-Z5 ESH3-Z5 ENV 4200 ENV 216 OFF	
PRESCAN PHASES FINAL PHASES ↓	
RUN SCAN	

THRESHOLD ON | OFF The *THRESHOLD ON | OFF* softkey activates or deactivates the *THRESHOLD SCAN* measurement function. This function will also be activated on opening the submenu with the *THRESHOLD SCAN* softkey from the *RECEIVER* main menu.

Remote command: `FME:THR OFF`

EDIT PEAK LIST The *EDIT PEAK LIST* softkey calls the *EDIT PEAK LIST* submenu used for editing the peak list.

The function of the softkeys are described under the *FINAL MEAS / EDIT PEAK LIST* submenu.

Further functions relating to the peak list are described in section [“Measurement of a Peak List” on page 4.129](#).

NO OF PEAKS With the *NO OF PEAKS* softkey, you can enter the number of final measurement peaks to be stored. Numbers between 1 and 500 can be entered. If the selected number is attained, no further final measurements will be performed.

Remote command: `:CALC:PEAK:SUBR 1...500`

NB/BB DISCR With the *NB/BB DISCR* softkey, you can enter the decision threshold to be used by the analyzer to discriminate between broadband and narrowband interference. Values between 0 dB and 200 dB can be entered.

Remote command: `:FME:NBBB ON | OFF`
`:FME:NBBB:LEVel 0..200dB`

- MARGIN** The *MARGIN* softkey activates the entry field of the margin, i.e. of an additional acceptance threshold for the determination of the peak list. The limit line currently used is shifted by this amount for defining the maxima. The range of values is -200 dB to 200 dB.
- Remote command: `:CALC:PEAK:MARG -200dB...200dB`
- FINAL MEAS TIME** The *FINAL MEAS TIME* softkey activates the entry field of the time of final measurement.
- Remote command: `FME:TIME <num_value>`
- AUTOMATIC FINAL** The *AUTOMATIC FINAL* softkey activates the automatic mode for the final measurement, i.e. a final measurement will be performed automatically and immediately each time a value out of limit is detected.
- Remote command: `:FME:AUTO ON`
- INTERACTIVE** The *INTERACTIVE* softkey selects the following sequence for the final measurement:
- The prescan is interrupted – *HOLD SCAN* state.
 - The bar graph measurement is started in the free running mode.
 - The signal can be exactly analyzed by modifying the receiver settings.
 - The actual final measurement is started, the receiver settings being restored except the frequency.
 - The current frequency replaces the original one in the frequency list (drifting interference sources).
 - The prescan is continued at the frequency at which it was interrupted.



With the *AUTOMATIC FINAL* softkey in the CONTINUE FINAL MEAS submenu a switchover can be made to the automatic mode before the measurement is started anew.

Remote command: `:FME:AUTO OFF`

- RUN SCAN** The *RUN SCAN* softkey starts the prescan. The *HOLD SCAN* submenu is called. For information about *RUN SCAN* refer to [“Running a Scan” on page 4.58](#)

Out-of-limit value for *AUTOMATIC FINAL*

If an out-of-limit value is detected, the R&S ESCI automatically goes to the HOLD SCAN state and starts the final measurement. The *HOLD FINAL MEAS Sequence for AUTOMATIC FINAL* submenu comes up. On completion of the final measurement, the R&S ESCI continues the prescan, and the *HOLD SCAN* submenu is displayed again.

Out-of-limit value for *INTERACTIVE*

If an out-of-limit value is detected, the R&S ESCI automatically goes to the HOLD SCAN state and starts the final measurement. The *HOLD FINAL MEAS Sequence for INTER ACTIVE* submenu comes up. On completion of the final measurement, the R&S ESCI continues the prescan, and the *HOLD SCAN* submenu is displayed again.

FINAL MEAS

The *FINAL MEAS* softkey opens the following submenu (receiver mode):

PEAK SEARCH		
EDIT PEAK LIST ↓	EDIT FREQUENCY	
	INSERT	
	DELETE	
	SORT BY FREQUENCY	
	SORT BY DELTALIMIT	
	ASCII FILE EXPORT	
	DECIM SEP	
	PAGE UP	
	PAGE DOWN	
NO OF PEAKS		
PEAKS SUBRANGES		
MARGIN		
FINAL MEAS TIME		
AUTOMATIC FINAL		
INTER ACTIVE		
RUN FINAL MEAS		
ESH2-Z5 ESH3-Z5 ENV 4200 ENV 216 OFF		
PRESCAN PHASES FINAL PHASES ↓	PHASE N PHASE L1 PHASE L2 PHASE L3	
	PE GROUNDED PE FLOATING	
RUN FINAL MEAS ↓	HOLD FINAL MEAS ↓	AUTOMATIC FINAL
		INTER ACTIVE
		SIKP FREQUENCY*
		GET MAXHOLD*
		MEASURE
	STOP FINAL MEAS	STOP FINAL MEAS

*) Dependent on the selected measurement mode AUTOMATIC FINAL or INTER ACTIVE.

PEAK SEARCH The *PEAK SEARCH* softkey starts the determination of the subrange maxima list from the available scan results. The procedure can be repeated as often as desired to try out different settings of margin and number of subranges.

Remote command: :CALC:PEAK

The following table shows the peak list which is determined by the peak search function after the prescan:

EDIT PEAK LIST (Prescan results)			
Trace1: 014QP			
Trace2: 014AV			
TRACE3: ---			
TRACE	FREQUENCY	LEVEL dB μ T	DELTA LIMIT dB
1 Average	80.0000 MHz	35.34	-3.91
2 Average	89.4800 MHz	38.83	-0.91
1 Max Peak	98.5200 MHz	47.53	-2.63
2 Average	98.5200 MHz	46.63	6.47
1 Max Peak	100.7200 MHz	54.14	3.88
2 Average	102.3200 MHz	50.89	10.56
1 Max Peak	113.2400 MHz	49.68	-1.08
2 Average	116.9200 MHz	44.81	3.91
1 Max Peak	125.8800 MHz	55.01	3.78
2 Average	125.8800 MHz	53.55	12.33
1 Max Peak	138.4800 MHz	45.68	-5.95
2 Average	138.4800 MHz	42.17	0.53
2 Average	144.0400 MHz	43.72	1.90
2 Average	167.0400 MHz	44.77	2.32
2 Average	176.2400 MHz	45.52	2.83
1 Max Peak	200.4800 MHz	52.49	-0.75
2 Average	200.4800 MHz	48.76	5.51
1 Max Peak	210.2800 MHz	60.55	7.09
2 Average	226.5600 MHz	59.02	15.24
2 Average	239.0000 MHz	48.59	4.75

EDIT PEAK LIST The *EDIT PEAK LIST* softkey calls the *EDIT PEAK LIST* submenu used for editing the peak list. A frequency list can thus be predefined and a final measurement carried out at these frequencies.

EDIT FREQUENCY
INSERT
DELETE
SORT BY FREQUENCY
SORT BY DELTALIMIT
ASCII FILE EXPORT
DECIM SEP
PAGE UP
PAGE DOWN

A peak list can also be generated by adopting the marker values (see section “Change of Settings via Markers – MKR-> Key” on page 4.63)

EDIT FREQUENCY The *EDIT FREQUENCY* softkey activates table *EDIT PEAK LIST*. The cursor marks the upper field of column *FREQUENCY*.

Remote command: --

INSERT The *INSERT* softkey creates an empty line above the current cursor position.

Remote command: --

DELETE The *DELETE* softkey erases the complete line at the cursor position. Before deletion, a message appears requesting confirmation.

Remote command: --

SORT BY FREQUENCY The softkey *SORT BY FREQUENCY* sorts the table in a descending order according to the entries in the *FREQUENCY* column.

Remote command: --

SORT BY DELTALIMIT The softkey *SORT BY DELTA LIMIT* sorts the table in a descending order according to the entries in the *DELTA LIMIT* column.

Remote command: --

ASCII FILE EXPORT The *ASCII FILE EXPORT* softkey stores the final measurement data in a file with ASCII format, e.g. on memory stick.

Remote command: FORM ASC;
MMEM:STOR:FIN 1, 'FINAL.DAT'

The file consists of the header containing important scaling parameters, several data sections containing the scan settings and a data section containing the results of the final measurement.

The data of the file header consist of three columns, each separated by a semicolon:

parameter name; numeric value; base unit

The data section for the trace data starts with the keyword " Trace <n> Final" (<n> = number of stored trace), followed by the measured data in one or several columns which are also separated by a semicolon.

This format can be read in from spreadsheet calculation programs, e.g. MS Excel. It is necessary to define ';' as a separator.



Different language versions of evaluation programs may require a different handling of the decimal point. It is therefore possible to select between separators '.' (decimal point) and ',' (comma) using softkey *DECIM SEP*.

DECIM SEP The *DECIM SEP* softkey selects the decimal separator between '.' (decimal point) and ',' (comma) with floating-point numerals for the function ASCII FILE EXPORT.

With the selection of the decimal separator different language versions of evaluation programs (e.g. MS Excel) can be supported.

Remote command: FORM:DEXP:DSEP POIN

Structure of the ASCII file

Table 4-1 RECEIVER mode, final measurement data – File header

Content of file	Description
Type; R&S ESCI;	Instrument model
Version;2.32;	Firmware version
Date;03.Aug 2004;	Date record storage date
Mode;Receiver;	Instrument operating mode
Start;10000;Hz	Start/stop of the display range.
Stop;100000;Hz	Unit: Hz
x-Axis;LIN;	Scaling of x axis linear (LIN) or logarithmic (LOG)
Scan Count;1;	Number of scans set
Transducer;TRD1;	Transducer name (if switched on)
Scan 1:	Loop over all defined scan ranges (1-10)
Start;150000;Hz	Range - start frequency in Hz
Stop;1000000;Hz	Range – stop frequency in Hz
Step;4000;Hz	Range - step width in Hz for linear step width or in% (1-100) for logarithmic step width
RBW;100000;Hz	Range - resolution bandwidth
Meas Time;0.01;s	Range - measurement time
Auto Ranging;ON;	Auto ranging on - or off for current range
RF Att;20;dB	Range - input attenuation
Auto Preamp;OFF;	Auto Preamp on or off for current range
Preamp;0;dB	Range - preamplifier on (20dB) or off (0dB)

Table 4-2 RECEIVER mode, final measurement data – Data section of the file

Content of file	Description
TRACE 1 FINAL:	Selected trace
Trace Mode;CLR/WRITE;	Trace mode: CLR/WRITE,AVERAGE,MAX HOLD,MIN HOLD, VIEW, BLANK
Final Detector, QUASIPeAK;	Final detector MAX PEAK, MIN PEAK, RMS, AVERAGE, QUASIPeAK, AC VIDEO
x-Unit;Hz;	Unit of x values:
y-Unit;dBuV;	Unit of y values:
Final Meas Time;1.000000;s	Final measurement time
Margin;6.000000;s	Margin
Values;8;	Number of test points
2;154000.000000;81.638535;15.638535;N;GND	Measured values: <Trace>;<x-value>, <y-value>; <phase>; <ground>
1;158000.000000;86.563789;7.563789;N;GND	Phase and protective grounding are output only if a line impedance stabilization has been activated. They specify the setting at which the maximum RFI level at the associated frequency was found.
2;1018000.000000;58.689873;-1.310127;N;GND	
...	

Example for exported final measurement data

```

Type;R&S ESCI;
Version;2.23;
Date;03.Mar 08;
Mode;Receiver;
Start;150000.000000;Hz
Stop;30000000.000000;Hz
x-Axis;LOG;
Scan Count;1;
Transducer;;
Scan 1:
Start;150000.000000;Hz
Stop;30000000.000000;Hz
Step;4000.000000;Hz
RBW;9000.000000;Hz
Meas Time;0.001000;s
Auto Ranging;OFF;
RF Att;10.000000;dB
Auto Preamp;OFF;
Preamp;0.000000;dB
TRACE 1 FINAL:
Trace Mode;CLR/WRITE;
Final Detector;MAX PEAK;
TRACE 2 FINAL:
Trace Mode;CLR/WRITE;
Final Detector;AVERAGE;
x-Unit;Hz;
y-Unit;dBuV;
Final Meas Time;1.000000;s
Margin;6.000000;dB
Values;11;
2;154000.000000;81.638535;15.638535;N;GND
1;158000.000000;86.563789;7.563789;N;GND
2;1018000.000000;58.689873;-1.310127;N;GND
2;302000.000000;63.177345;-2.822655;L1;GND
2;3294000.000000;56.523022;-3.476978;N;GND
2;1122000.000000;53.849747;-6.150253;N;GND
2;10002000.000000;47.551216;-12.448784;N;GND
1;3390000.000000;59.762917;-13.237083;N;GND
1;9998000.000000;58.309189;-14.690811;L1;GND
2;20002000.000000;45.142456;-14.857544;L1;GND
2;7502000.000000;36.406967;-23.593033;L1;GND

```

NO OF PEAKS The **NO OF PEAKS** softkey activates the entry field of the number of subranges or peaks for the determination of the peak list. The range of values is 1 to 500.

Remote command: :CALC:PEAK:SUBR 1 to 500

PEAKS SUBRANGES	The <i>PEAKS SUBRANGES</i> softkey defines the search method with which maxima are searched for within a scan.
PEAKS	Determination of a specific number of peak values relative to the limit lines with the level values being independent of their frequency spectral distribution.
SUBRANGES	Generating subrange maxima, i.e. the interference spectrum is further analyzed at frequencies with the highest interference level of a frequency subrange.

Remote command: :CALC:PEAK:METH SUBR|PEAK

MARGIN	The <i>MARGIN</i> softkey activates the entry field of the margin, i.e. of an additional acceptance threshold for the determination of the peak list. The limit line currently used is shifted by this amount for defining the maxima. The range of values is -200 dB to 200 dB.
--------	--

Remote command: :CALC:PEAK:MARG -200dB to 200dB

FINAL MEAS TIME	The <i>FINAL MEAS TIME</i> softkey activates the entry field of the time of final measurement.
--------------------	--

Remote command: FME:TIME <num_value>

AUTOMATIC FINAL	The <i>AUTOMATIC FINAL</i> softkey selects the automatic routine for the final measurement. This routine is run according to the available frequency list without user interaction.
--------------------	---

Remote command: :FME:AUTO ON

INTER ACTIVE	The <i>INTERACTIVE</i> softkey selects the following sequence for the final measurement:
-----------------	--

- A frequency from the frequency list is set together with the associated settings from the corresponding partial scan.
- The marker is set on this frequency in the scan diagram.
- The final measurement sequence switches to the *Interrupted* status.
- The signal can be exactly analyzed by modifying the receiver settings.
- *CONTINUE AT HOLD* starts the actual final measurement, the receiver settings being restored except the frequency.
- The current frequency replaces the original one in the frequency list (drifting interference sources)
- Next frequency of frequency list.....



With the *AUTOMATIC FINAL* softkey in the *CONTINUE FINAL MEAS* submenu a switchover can be made to the automatic mode before the measurement is started anew.

Remote command: :FME:AUTO OFF

RUN FINAL MEAS

Sequence for *RUN FINAL MEAS*

The *RUN FINAL MEAS* softkey starts the final measurement sequence as described below. The *HOLD FINAL MEAS* submenu is called.

Dependent on the selected measurement mode (*AUTOMATIC FINAL* or *INTER ACTIVE*) for the final measurement, two different submenus of the *HOLD FINAL MEAS* menu are displayed.

The detectors used for the final measurement replace those used in the list or for the prescan.

The out-of-limit condition is shown by a plus sign preceding the values in the *DELTA LIMIT* column (see table below).

Remote command: --



The final measurement function is only available in the manual operation. For operation under program control it is preferable to read the prescan results and the data-reduced peak list, if any, from the R&S ESU with the controller and carry out the individual measurements with the controller. This considerably makes the control of the interactive mode easier.

HOLD FINAL MEAS

Dependent on the selected measurement mode (*AUTOMATIC FINAL* or *INTER ACTIVE*) for the measurement, two different submenus of the *HOLD FINAL MEAS* menu are displayed.

The *HOLD FINAL MEAS* softkey interrupts the automatic run of the final measurement.

The *CONTINUE FINAL MEAS* submenu appears.

Sequence for *AUTOMATIC FINAL*

HOLD FINAL MEAS↓	AUTOMATIC FINAL
	INTER ACTIVE
	MEASURE
	STOP FINAL MEAS
STOP FINAL MEAS	

With the final measurement halted all receiver settings can be modified for example for examining the signal in detail.

The mode of the measurement (automatic or interactive) can again be selected.

The final measurement can be started with the *MEASURE* softkey.

Remote command: --

AUTOMATIC FINAL

The *AUTOMATIC FINAL* softkey selects the automatic mode for the final measurement (see above).

Remote command: :FME:AUTO ON

INTER ACTIVE The *INTERACTIVE* softkey selects the interactive mode for the final measurement as described above.

Remote command: :FME:AUTO OFF

MEASURE The *MEASURE* softkey continues with the final measurement. The final measurement starts at the next frequency entry on the peak list or at a marked frequency if one or several lines have been skipped with the *SKIP FREQUENCY* softkey.

Remote command: --

STOP FINAL MEAS The *STOP FINAL MEAS* softkey halts the final measurement. The final measurement starts from the beginning on a new start. The previously collected data is lost.

Remote command: --

Sequence for *INTER ACTIVE*

HOLD SCAN	AUTOMATIC FINAL
	INTER ACTIVE
	SIKP FREQUENCY
	GET MAXHOLD
	MEASURE
STOP SCAN	
	STOP FINAL MEAS

With the final measurement halted all receiver settings can be modified for example for examining the signal in detail.

The mode of the measurement (automatic or interactive) can be selected again. The final measurement can be skipped. The highest level measured can be accepted by *GET MAXHOLD*. The final measurement can be started with the *MEASURE* softkey.

Remote command: --

AUTOMATIC FINAL The *AUTOMATIC FINAL* softkey selects the automatic mode for the final measurement (see above).

Remote command: :FME:AUTO ON

INTER ACTIVE The *INTERACTIVE* softkey selects the interactive mode for the final measurement as described above.

Remote command: :FME:AUTO OFF

SIKP FREQUENCY The *SIKP FREQUENCY* softkey skips the final measurement and continues with the prescan.

Remote command: --

GET MAXHOLD The *GET MAXHOLD* softkey accepts the highest level measured during the HOLD SCAN state as a result for the final measurement and continues the prescan. (The level value in question is displayed as a small bar in the bargraph.)

Remote command: --

MEASURE The *MEASURE* softkey continues with the final measurement. The final measurement starts at the next frequency entry on the peak list or at a marked frequency if one or several lines have been skipped with the *SKIP FREQUENCY* softkey.

Remote command: --

STOP FINAL MEAS The *STOP FINAL MEAS* softkey halts the final measurement. The final measurement starts from the beginning on a new start. The previously collected data is lost.

Remote command: --

The peak list available after the final measurement:

EDIT PEAK LIST (Final Measurement Results)			
Trace1:	014QP		
Trace2:	014AV		
TRACE3:	---		
TRACE	FREQUENCY	LEVEL dBpT	DELTA LIMIT dB
1	Average	80.0000 MHz	-9.25
2	Average	89.4800 MHz	-4.09
1	Quasi Peak	98.5200 MHz	-0.22
2	Average	98.5200 MHz	8.15
1	Quasi Peak	100.7200 MHz	5.07
2	Average	102.3200 MHz	10.53
1	Quasi Peak	113.2400 MHz	-8.26
2	Average	116.9200 MHz	3.53
1	Quasi Peak	125.8800 MHz	3.68
2	Average	125.8800 MHz	12.64
1	Quasi Peak	138.4800 MHz	-9.81
2	Average	138.4800 MHz	-2.25
2	Average	144.0400 MHz	-1.04
2	Average	167.0400 MHz	2.37
2	Average	176.2400 MHz	3.87
1	Quasi Peak	200.4800 MHz	-2.31
2	Average	200.4800 MHz	5.02
1	Quasi Peak	210.2800 MHz	5.25
2	Average	226.5600 MHz	15.29
2	Average	230.0000 MHz	3.05

4.5.4.6 Selection of Detectors for Final Measurement

The selection of detectors for the final measurement is made in the right side menu *TRACE DETECTOR* (see section “[Selection and Setting of Traces – TRACE Key](#)” on page 4.68).

The detectors to be used for the final measurement can be set here for each trace, i.e. any combination of prescan and final measurement is possible. The required flexibility is thus obtained for the diverse test specifications which are covered by means of the R&S ESCI.

In the *THRESHOLD SCAN* mode, with the *NB/BB DISCR* function active, the R&S ESCI automatically selects the detector to be used in the final measurement on the basis of the results obtained in the prescan.

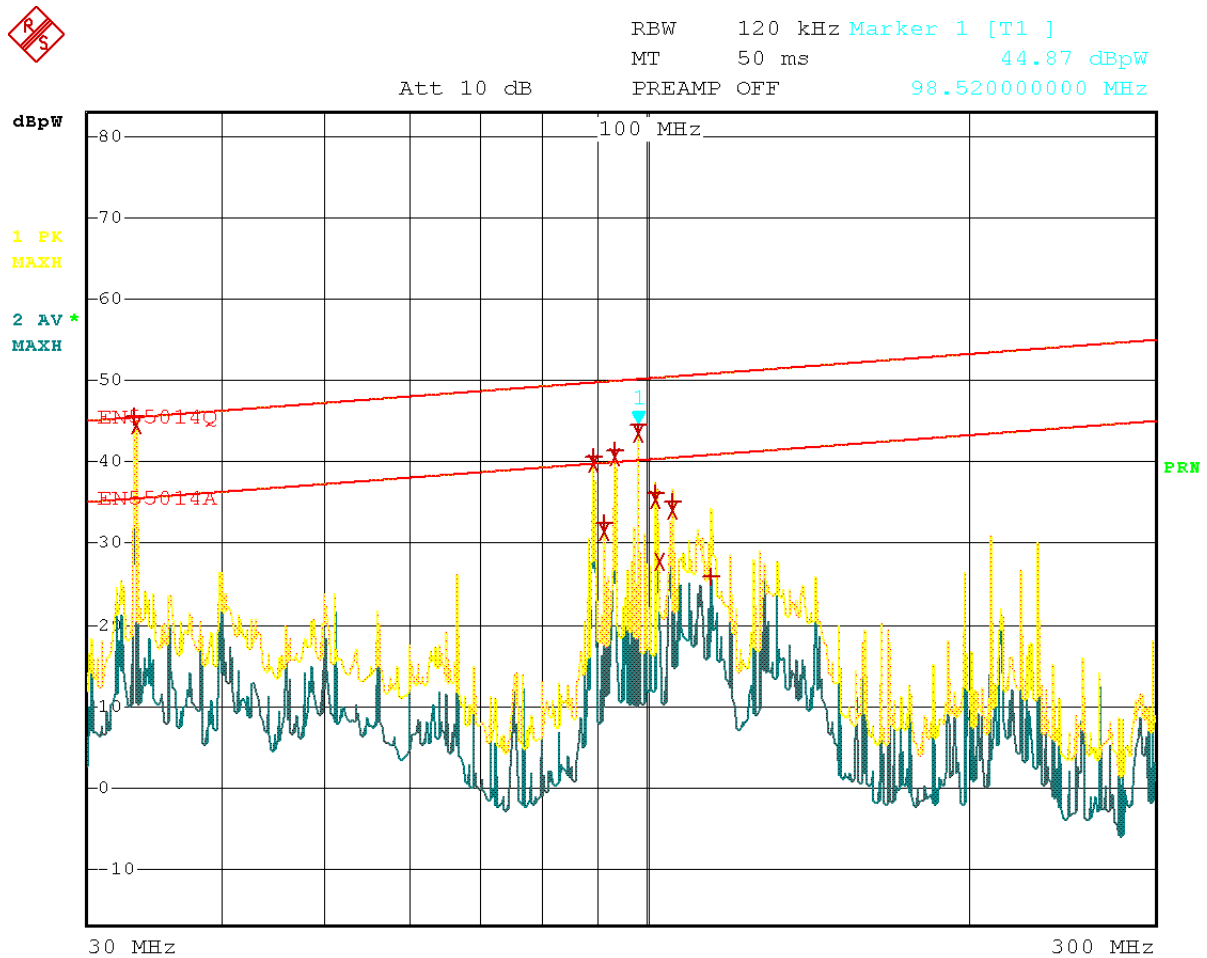

Date: 8.AUG.2001 16:41:37

Fig. 4.15 Results of prescan and final measurement

Automatic Control of Line Impedance Stabilization Networks

The selected phases are controlled during the prescan and the final measurement via the USERPORT with the LISN switched on.

Only one phase and one PE setting (1 out of n) can be selected for the prescan. Any number of settings can be selected for the final measurement (m out of n).

All selected phase/PE combinations are measured during the final measurement and the maximum value is determined.

The softkeys to select the V-network to be controlled in the *PRESCAN PHASES* and in the *FINAL PHASES* are available either via the side menu of the *FINAL MEAS* submenu or via the side menu of the *THRESHOLD SCAN* submenu.

In contrast, the *LISN* menu in the *SETUP* menu is used for the direct control of the LISN and is not included in the automatic sequences.

In the **FINAL MEAS** side menu, the following softkeys are available:

ESH2-Z5 ESH3-Z5 ENV 4200 ENV 216 OFF		
PRESCAN PHASES FINAL PHASES↓	PHASE N PHASE L1 PHASE L2 PHASE L3	
	PE GROUNDED PE FLOATING	
RUN FINAL MEAS↓	HOLD FINAL MEAS↓	AUTOMATIC FINAL
		INTER ACTIVE
		MEASURE
	STOP FINAL MEAS	STOP FINAL MEAS

ESH2-Z5 | The *ESH2-Z5*, *ESH3-Z5*, *ENV 4200*, *ENV 216* and *OFF* softkeys allow to select the
ESH3-Z5 | V-network to be controlled via the user port.
ENV 4200 |
ENV 216 |
OFF |

ESH2-Z5 four-line V-network is controlled.
ESH3-Z5 two-line V-network is controlled.
ENV 4200 four-line V-network is controlled.
ENV 216 two-line V-network is controlled.
OFF remote control is deactivated.

Remote command: :INPut:LISN[:TYPE] TWOPhase | FOURphase |
ENV4200 | ENV216 | OFF

PRESCAN PHASES | The *PRESCAN PHASES* and *FINAL PHASES* softkeys open the submenu for the
FINAL PHASES | selection of phase and protective earth setting.

PRESCAN PHASES: Softkeys *ESH2-Z5*, *ESH3-Z5*, *ENV 4200*, *ENV 216* and
OFF or *PHASE N*, *PHASE L1*, *PHASE L2* and *PHASE L3* as well as *PE GROUNDED* and *PE FLOATING* are
toggle keys. Only one of them can be activated at a time.

FINAL PHASES: All combinations of phases and PE setting are possible.

PHASE N | The *PHASE N*, *PHASE L1*, *PHASE L2* and *PHASE L3* softkeys select the phase of
PHASE L1 | the V-network on which the RFI voltage is to be measured.
PHASE L2 |
PHASE L3 |

PHASE N RFI on phase N is measured,
PHASE L1 RFI on phase L1 is measured,
PHASE L2 RFI on phase L2 is measured
(only for *ESH2-Z5/ENV 4200*),
PHASE L3 RFI on phase L3 is measured
(only for *ESH2-Z5/ENV 4200*).

Remote command: :INP:LISN:PHAS L1 | L2 | L3 | N

PE GROUNDED | The *PE GROUNDED* and *PE FLOATING* softkeys switch the protective earth con-
PE FLOATING | ductor chokes on or off.

PE GROUNDED protective earth conductor choke switched off,
PE FLOATING protective earth conductor choke switched on.

Remote command: :INP:LISN:PEAR GRO |FLO

Settings made in the *PRESCAN PHASES* menu are immediately output at the user port. This way, the menu can be used to remote control the V-networks during manual measurements.

For automatic phase selection with the V-networks, the R&S ESCI user interface and the V-networks have to be connected via a control line:

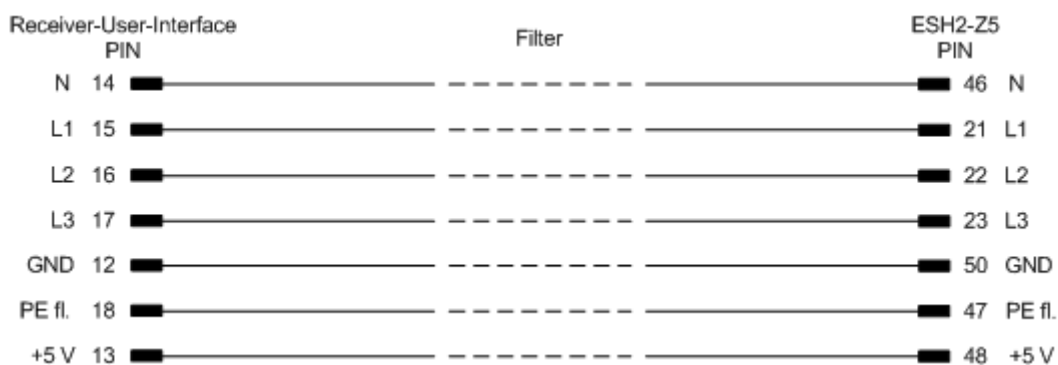

Fig. 4.16 Connection R&S ESCI with R&S ESH2-Z5 (for direct connection without a filter: cable EZ-13)

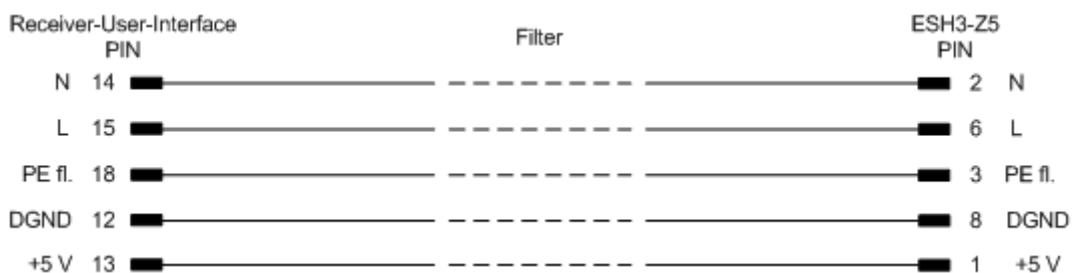

Fig. 4.17 Connection R&S ESCI with R&S ESH3-Z5 (for direct connection without a filter: cable EZ-14, model 02)

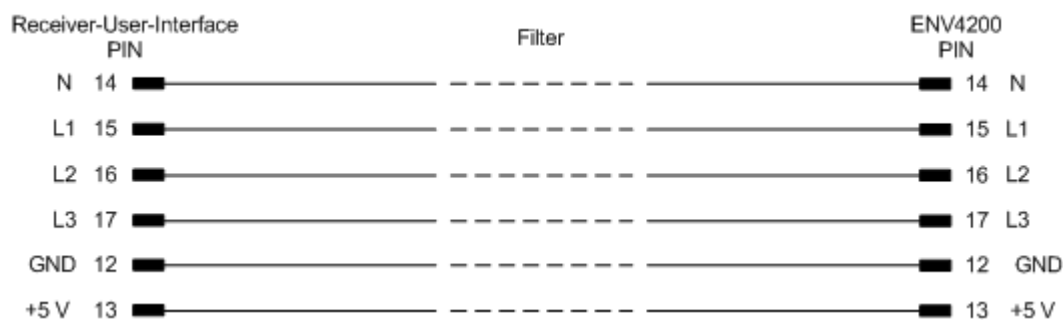

Fig. 4.18 Connection R&S ESCI with R&S ENV4200 (for direct connection without a filter: cable EZ-21)

For controlling the phase selection and the PE simulating network of the V-networks ESH2-Z5, ESH3-Z5 and ENV4200, the +5-V supply voltage and some control lines are to be routed through the wall of the shielded room.

The connection cables EZ-14 and EZ-5 can be provided for the 4-line V-network ESH2-Z5, the connection cable EZ-14 and EZ-6 for the two-line V-network ESH3-Z5 and the connection cables ES-14 and EZ-21 for the 4-line V-network ENV4200.



When the R&S ESCI is used inside the shielded room, the filter configuration is omitted. The cable EZ-14 is then used for controlling the R&S ESH3-Z5, the cable EZ-13 for controlling the R&S ESH2-Z5, and the cable EZ-21 for controlling the R&S ENV4200.

Suggested configuration of cables EZ-14/EZ-5/EZ-6/EZ-21

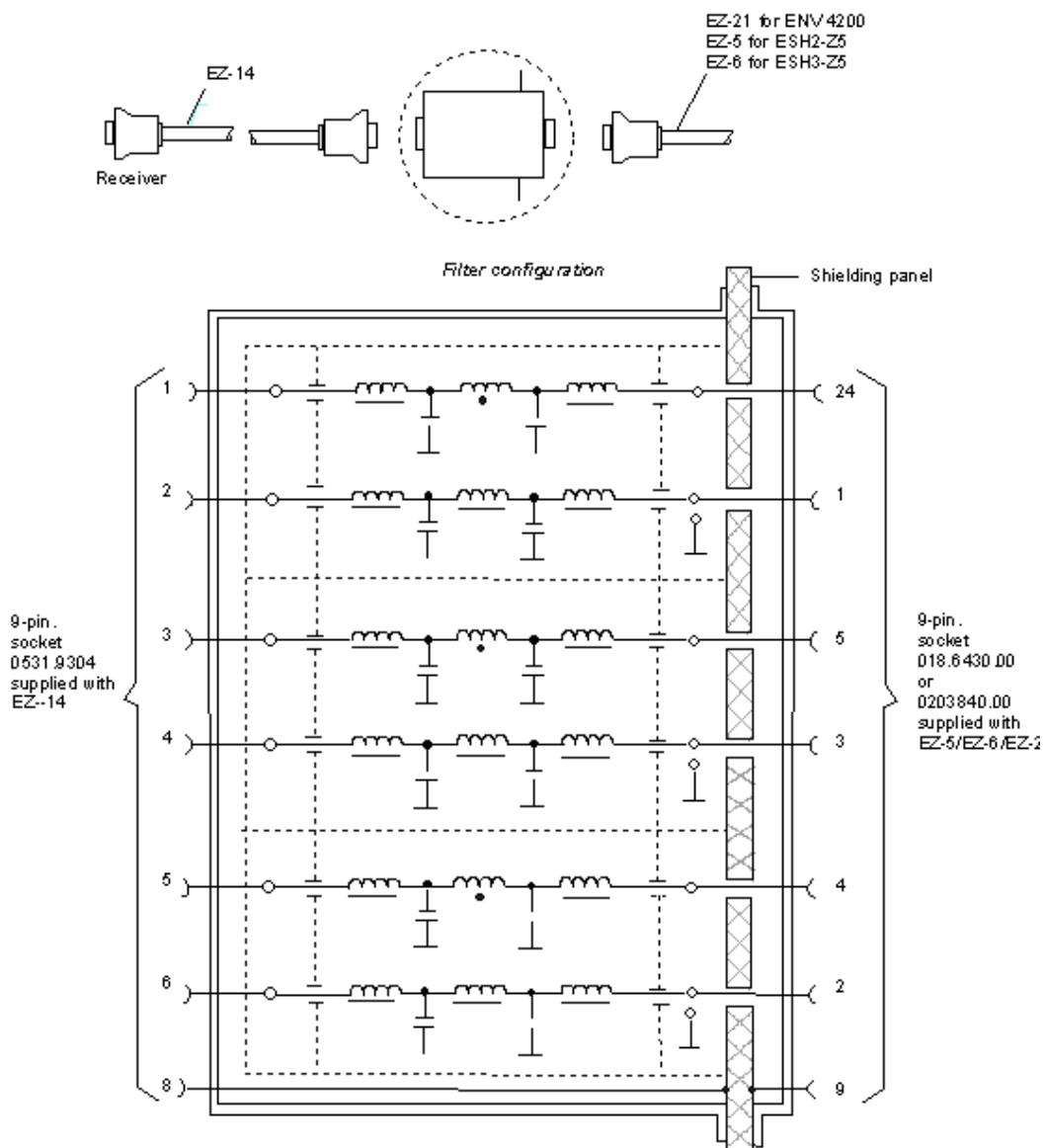

Fig. 4.19 Assignment of connection cables EZ-5, -6, -14 and -21 with AF filters for feeding the 5-V supply and the control information for the V-networks R&S ESH2-Z5, R&S ESH3-Z5 and R&S ENV4200 into a shielded room.

4.5.5 Frequency Scan and Time Domain Scan – SWEEP Key

4.5.5.1 Stepped Scan in the Frequency Domain

In the scan mode, R&S ESCI measures in a predefined frequency range with selectable step width and measurement time for each frequency.

Either the current receiver settings or the settings defined in the Scan table are used. Up to 10 subranges which need not be next to each other can be defined within one scan. The subranges are then scanned by R&S ESCI one after the other. Measurement ranges should not overlap. The parameters to be measured in each subrange can be selected independently (*SWEEP* menu, *SCAN TABLE* table).

Transducer factors or transducer sets and limit lines can be defined and displayed separately and are not part of the scan data record.

The scanned frequency range is defined by the start and stop frequency set independently of the scan table (*SCAN TABLE* table or *FREQUENCY* menu). A scan table can thus be defined for each measurement task, which can be stored and reloaded. The required frequency range can be defined by means of two parameters which can be set via keys so that no elaborate editing has to be done in the scan table.

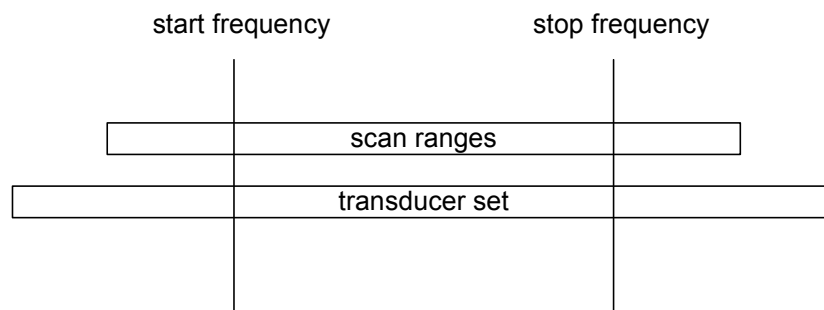

Fig. 4.20 Definition of scan range

Scanning is started with the *RUN SCAN* softkey. The scan can be performed as a single scan or continuously. In the case of single scan it is stopped when the stop frequency is reached. The continuous scan can be interrupted with the *HOLD SCAN* softkey or terminated with the *STOP SCAN* softkey.

The maximal number of measured frequencies is limited to 1.000.000. A maximum of 3 x 1.000.000 values (1.000.000 per detector) can be stored for postprocessing. If the scan subranges are defined so that more than the possible values would be measured, a respective message is output upon the scan start. Afterwards the scan is performed up to the maximum value.

At least one scan is defined in the list. Two subranges are defined in the default setup. All other parameters are shown in the following table:

Table 4-1 Default setup of scan table

	Range 1	Range 2
Start frequency	150 kHz	30 MHz
Stop frequency	30 MHz	1 GHz
Step width	Auto	Auto
IF bandwidth	9 kHz	120 kHz
Measurement time	1 ms	100 μ s
Auto ranging	OFF	OFF
Attenuation mode	Normal	Normal
RF attenuation	10 dB	10 dB
Preamplification	OFF	OFF

The diagram parameters to be defined are: start frequency 150 kHz, stop frequency 1 GHz, min. level 0 dB μ V, grid range log 100 dB, log. frequency axis and continuous scan.

The measurement parameters correspond to the settings recommended for overview measurements to CISPR 16.

4.5.5.2 Scan in the Time Domain

It is also possible to carry out the scan in the time domain, i.e. at a fixed frequency. Time domain analysis is generally used to examine the time characteristics of interferences. Evaluating the detected voltage with an oscilloscope is useful in order to correctly set the receiver measurement time. By doing so, you can determine whether and how strongly a narrowband interference fluctuates and whether it is amplitude-modulated or pulsed. You can also determine the pulse rate of a broadband interference. You can set the measurement time to a value that is greater than or equal to the reciprocal of the pulse rate.

Thermostat-controlled, software-controlled and other electrically controlled instruments generate discontinuous interferences. CISPR 14 and EN 55014 contain limit values for RFI voltage with click rate weighting in the range 0.15 MHz to 30 MHz. Clicks can usually be measured using click rate analyzers. However, a factor that is often critical in click rate measurements is the occurrence of successive pulses whose individual pulse heights cannot be exactly assigned by using the time constants of the quasipeak weighting and can thus lead to the limit value being exceeded.

Time domain analysis can determine the pulse height and duration, which can be useful in such cases. It meets the requirements of CISPR 16-1 with regard to accuracy of the pulse duration measurement when the pulse duration is 10 ms and longer. Triggering can be performed internally – level set with display line – or externally with a TTL level.

The result memory capacity is 1 440 001 measured values per trace in time domain analysis. The measured values are stored internally and can, for example, then be analyzed by zooming in on them with the marker. At a measurement time of 5 ms per measured value, the memory depth is large enough to record the peak value and quasipeak value continuously for two hours. Thus, measurement objects such as washing machines can be evaluated for click interferences.

Once measurement has been completed, the display of the measured values can be enlarged down to the individual measured values by using the zoom function. Thus, each individual click interferer can be evaluated in detail if necessary.

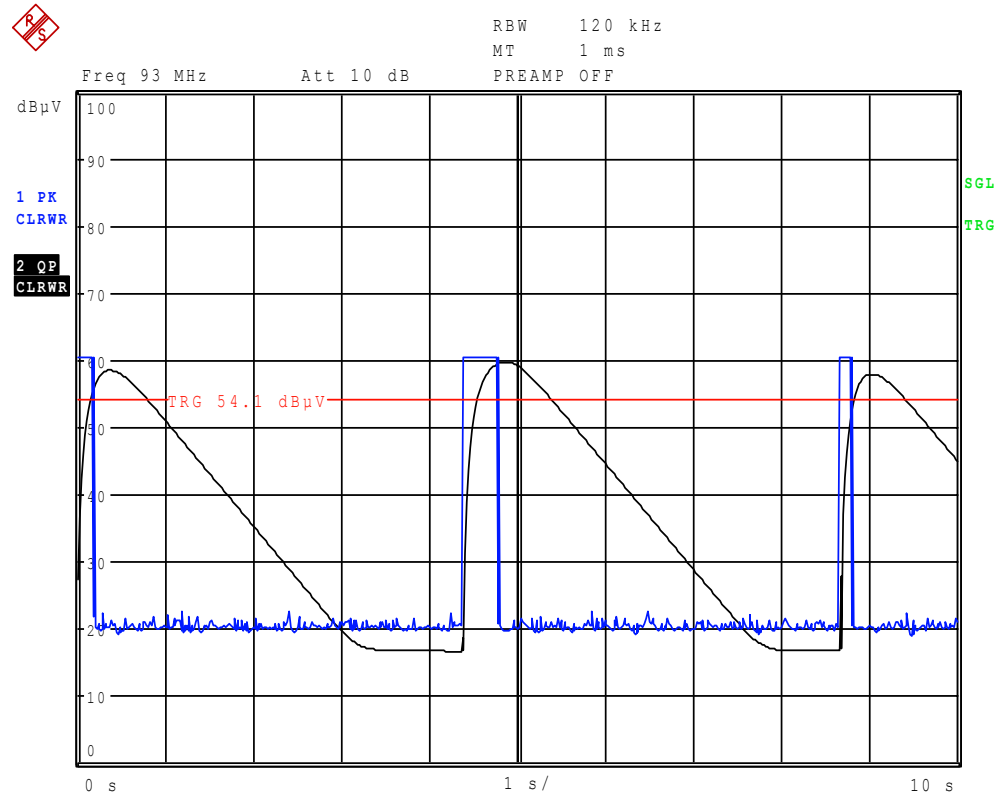

Fig. 4.21 Scan in the time domain

Time domain analysis is started with the *RUN* softkey. It can be performed as a single operation (*SINGLE*) or as a repeating operation (*CONTINUOUS*). In *SINGLE* operation, time domain analysis stops after the total run time has elapsed. In *CONTINUOUS* operation, time domain analysis can either be interrupted with the *HOLD SCAN* softkey or stopped with the *STOP SCAN* softkey. The measurement itself is continuous, i.e. if the end of the graph is reached and recording starts again at the beginning of the graph, the measurement keeps running internally without any interruption.

4.5.5.3 Display of Measurement Results

Full-screen or split-screen mode can be selected for result display. In the full-screen mode, the result diagram covers the whole screen area.

In split-screen mode, the upper half of the screen displays the frequency and level readout, i.e. a bar graph. The diagram is displayed in the lower half.

Up to 3 detectors can be measured simultaneously. They are assigned to traces 1 to 3. Since the detectors are set only once, it is not possible to measure with different detectors in different the subranges.

4.5.5.4 Entry of Scan Data

SWEEP

Pressing the *SWEEP* key opens the menu to configure and start the scan.

USE SCAN TABLE↓	ADJUST AXIS		
	INS BEFORE RANGE		
	INS AFTER RANGE		
	DELETE RANGE		
	RANGES 1-5 6-10		
	FREQ AXIS LIN LOG		
	10dB MIN ON OFF		
	RUN PRE- SCAN+FINAL		
	RUN SCAN	HOLD SCAN	CONT AT REC FREQ
			CONT AT HOLD
			STOP SCAN
		STOP SCAN	
USE CURR SETTINGS			
TIME DOMAIN			
SINGLE SCAN			
CONTINUOUS SCAN			
FREQ AXIS LIN LOG			
RUN PRE- SCAN+FINAL			
RUN SCAN	HOLD SCAN	CONT AT REC FREQ	
	STOP SCAN	CONT AT HOLD	
		STOP SCAN	

A scan is defined in the form of tables or it is performed using the current setting.

In the *SCAN* table, the scan subranges are defined. Each scan range is specified by start frequency, stop frequency, step width and the measurement parameters that are valid for this range.

The scan can be performed as a single scan or continuously (softkeys *SINGLE SCAN* and *CONTINUOUS SCAN*).

Scanning is started with the *RUN SCAN* softkey.

**USE SCAN
TABLE**

ADJUST AXIS		
INS BEFORE RANGE		
INS AFTER RANGE		
DELETE RANGE		
RANGES 1-5 6-10		
FREQ AXIS LIN LOG		
10dB MIN ON OFF		
RUN PRE- SCAN+FINAL		
RUN SCAN	HOLD SCAN	CONT AT REC FREQ
		CONT AT HOLD
	STOP SCAN	STOP SCAN

The *USE SCAN TABLE* softkey opens a submenu where existing scan tables can be edited or new ones created. Tables with the current scan settings are displayed.

Remote command: --

In the *SCAN TABLE* the parameters for the individual subranges can be set.

Scan Start - start frequency of display range

Scan Stop - stop frequency of display range

Step Mode - selection of frequency switching mode

Start - Entry of start frequency

Stop - Entry of stop frequency

Step Size - Entry of step size

RES BW - Entry of IF bandwidth

Meas Time - Entry of measurement time

Auto Ranging - Activates the autorange function

RF Atten - Entry of a fixed RF attenuation

Preamp - Switching the preamplifier on and off

Auto Preamp - Activates the auto preamp function

SCAN TABLE					
Scan Start	20.000 MHz				
Scan Stop	1.250 GHz				
Step Mode	LIN				
	RANGE1	RANGE2	RANGE3	RANGE4	RANGE5
Start	150.000 kHz	30.000 MHz	1.000 GHz		
Stop	30.000 MHz	1.000 GHz	2.000 GHz		
Step Size	4 kHz	40 kHz	400 kHz		
Res BW	9 kHz	120 kHz	1 MHz		
Meas Time	1 ms	100 us	100 us		
Auto Ranging	OFF	OFF	OFF		
RF Attn	10 dB	10 dB	10 dB		
Preamp	OFF	OFF	OFF		
Auto Preamp	OFF	OFF	OFF		

Scan Start - start frequency of display range

Range is f_{\min} to $f_{\max} - 10$ Hz

This value can also be set in the *FREQ* menu (*START* softkey).

Remote command: `FREQ:STAR 20 MHz`

Scan Stop - stop frequency of display range

Range is f_{\min} to f_{\max} .

This value can also be set in the *FREQ* menu (*STOP* softkey).

Remote command: `FREQ:STOP 1250 MHz`

Step Mode - selection of frequency switching mode

Linear or logarithmic frequency switching can be selected. The selected setting is valid for all scan ranges.

LIN linear frequency switching.

AUTO linear frequency switching.

The step width is selected automatically depending on the set resolution bandwidth so that all signals occurring in the scan range are reliably detected without any significant measurement error (about one third of resolution bandwidth).

LOG logarithmic frequency switching.

The frequency is incremented in % of the current frequency.

Remote command: `SWE:SPAC LIN`

Start - Entry of start frequency

The start frequency of a subrange must be equal to or greater than the stop frequency of the previous subrange.

On entering the start frequency, the preceding scan range is – if necessary – adapted automatically to avoid overlapping of scan ranges.

Remote command: `SCAN1:STAR 150 kHz`

Stop - Entry of stop frequency

The stop frequency of a subrange must be equal to or greater than the start frequency of the subrange.

On entering the stop frequency, the preceding scan range is – if necessary – adapted automatically to avoid overlapping of scan ranges.

Remote command: `SCAN1:STOP 30 MHz`

Step Size - Entry of step size

In the case of linear frequency increments, step widths between 1 Hz and the maximum R&S ESCI frequency can be set. When a step size greater than the scan range is entered (from start to stop), R&S ESCI performs a measurement at the start and stop frequency.

With logarithmic frequency increments, values between 0.1% and 100% can be set with steps of 1/2/3/5.

With *STEP AUTO* selected, the step size cannot be changed because it is automatically set with respect to the IF bandwidth.

Remote command: `SCAN1:STEP 4 kHz`

RES BW - Entry of IF bandwidth

In the case of quasipeak weighting, usually a fixed bandwidth is set which cannot be changed (CISPR).

However, the coupling of the IF bandwidth to the frequency range can be cancelled using softkey *CISPR RBW UNCOUPLED* in the *MEAS DETECTOR* menu.

Remote command: `SCAN1:BAND:RES 9 kHz`

Meas Time - Entry of measurement time

The measurement time can be set between 100 μ s and 100 s separately for each subrange. In the case of quasipeak weighting, the minimum is 1 ms. The measurement time can be set independently for each scan range.

Remote command: `SCAN1:TIME 1ms`

Auto Ranging - Activates the autorange function**NOTICE**

If 0 dB RF attenuation is used with autoranging, care must be taken that the permissible signal level at the RF input is not exceeded.

Exceeding this level would damage the input mixer.

The 0 dB attenuation should under no circumstances be used when RFI voltage measurements are performed with the aid of artificial networks as in this case very high pulses occur during phase switching.

ON R&S ESCI automatically sets the input attenuation as a function of the signal level.

OFF The input attenuation setting of the scan table is used.

Remote command: `SCAN1:INP:ATT:AUTO OFF`

RF Atten - Entry of a fixed RF attenuation

The RF attenuation can be set separately for each subrange.

Remote command: `SCAN1:INP:ATT 10dB`

Preamp - Switching the preamplifier on and off

The preamplifier can be switched on/off separately for each subrange.

Remote command: `SCAN1:INP:GAIN:STAT OFF`

Auto Preamp - Activates the auto preamp function

ON The preamplifier is considered in autoranging. It is only cut in after the attenuation has been reduced to the minimum settable value.

OFF Auto ranging without preamplification.

Remote command: `SCAN1:INP:GAIN:AUTO OFF`

ADJUST AXIS	The <i>ADJUST AXIS</i> softkey automatically sets the limits of the diagram so that the lower limit frequency corresponds to the start frequency of range 1 and the upper limit frequency to the stop frequency of the last range.
	Remote command: <code>--</code>
INS BEFORE RANGE	The <i>INS BEFORE RANGE</i> softkey shifts the active scan range in the table to the left by one column. A new column with identical settings is created. The limit frequencies can be changed accordingly.
	Remote command: <code>--</code>
INS AFTER RANGE	The <i>INS AFTER RANGE</i> softkey shifts the active scan range in the table to the right by one column. A new column with identical settings is created. The limit frequencies can be changed accordingly.
	Remote command: <code>--</code>
DELETE RANGE	The <i>DELETE RANGE</i> softkey clears the activated scan range. All other ranges are shifted to the left by one column.
	Remote command: <code>--</code>
RANGES 1-5 6-10	With the <i>RANGES 1-5 6-10</i> softkey a switchover can be made between ranges 1-5 and 6-10.
	Remote command: <code>--</code>
FREQ AXIS LIN LOG	For details refer to “FREQ AXIS LIN LOG” on page 4.58.
10dB MIN ON OFF	For details refer to “10 DB MIN ON OFF” on page 4.17 (AMPT menu).
RUN PRE- SCAN+FINAL	For details refer to “Triggering the Scan – TRIG Key” on page 4.59.
RUN SCAN	For details refer to “RUN SCAN” on page 4.58.

USE CURR SETTINGS The *USE CURR SETTINGS* softkey activates a scan which is performed using the current receiver settings. The step size is automatically set with respect to the IF bandwidth (Step Mode Auto). The start and stop frequency is set via the *FREQUENCY* menu.

Remote command: --

TIME DOMAIN The *TIME DOMAIN* softkey activates time domain analysis.

The overall measurement time for time domain analysis can be defined in a data entry field. The range is 100 μ s to 10.000 s. The value entered is rounded to next integer that is a multiple of the measurement time of a single bar graph measurement. The minimum value also depends on the set measurement time of a single bar graph measurement and is at least twice this value.

Remote command: FREQuency:MODE CW
 SCAN:TDOMain 100 s

SINGLE SCAN Pressing the *SINGLE SCAN* softkey triggers a frequency scan. R&S ESCI stops at the end frequency.

The enhancement label SGL displayed at the screen edge indicates that the single-scan mode is set.

Remote command: :INIT2:CONT OFF

CONTINUOUS SCAN The *CONTINUOUS SCAN* softkey selects the continuous scan mode. R&S ESCI scans continuously until the scan is stopped.

Remote command: :INIT2:CONT ON

FREQ AXIS LIN | LOG The *FREQ AXIS LIN | LOG* switches between linear and logarithmic frequency axis. Default is LOG.

Remote command: DISP:TRAC:X:SPAC LOG

RUN PRE-SCAN+FINAL The *RUN PRE-SCAN+FINAL* softkey is starting a sequence, consisting of a pre-scan, the peak search-function and the final measurement.

Remote command: INIT2:EMIT

RUN SCAN

4.5.5.5 Running a Scan

HOLD SCAN	CONT AT REC FREQ
STOP SCAN	CONT AT HOLD
	STOP SCAN

The *RUN SCAN* softkey starts the frequency scan with the selected settings. The *HOLD SCAN* submenu is displayed instead of the menu shown before the scan is started.

At the beginning of the scan, R&S ESCI sets up the diagram as specified in the scan table and starts the scan in the selected mode (*SINGLE* or *CONTINUOUS*). With *SINGLE* selected, R&S ESCI performs a single scan and stops at the end frequency. With *CONTINUOUS* selected, the scan is performed continuously until it is deliberately stopped.

The measurement can be interrupted with *HOLD SCAN* or stopped with *STOP SCAN*. The two softkeys are displayed instead of the menu shown before the scan is started.

If a transducer set is defined with points of changeover, the scan automatically stops at the frequencies of the new subrange of the transducer set and the user may exchange the transducer.

The following message informs the user that the limit has been reached:

TDS Range # reached, CONTINUE / BREAK

He can continue the scan at the point of change over by confirming the message (*CONTINUE*) or he can switch off the transducer (*BREAK*).

Remote command: INIT2

HOLD SCAN The *HOLD SCAN* softkey interrupts the scan.

The scan stops at the frequency at which it was interrupted until it is continued with the *CONT AT REC FREQ* or *CONTINUE AT HOLD* softkeys.

While the scan is stopped, the receiver settings can be changed, e.g. for a detailed analysis of the recorded trace.

Remote command: : HOLD

CONT AT REC FREQ With the *CONT AT REC FREQ* softkey the scan is continued at the current receiver frequency when the receiver frequency is lower than the frequency at which the scan was interrupted. Otherwise the scan continues at the frequency at which it was interrupted.

The scan is always continued with the settings in the scan table.

Remote command: : INIT2

CONT AT HOLD With the *CONT AT HOLD* softkey the scan is continued where it was interrupted. The scan is always continued with the settings in the scan table.

Remote command: --

STOP SCAN The *STOP SCAN* softkey stops the scan. Upon restart, scanning starts at the beginning. The results of the performed measurements are lost.

Remote command: : ABOR

4.5.6 Triggering the Scan – TRIG Key

The *TRIG* key opens a menu for selection of the trigger sources and the trigger polarity. The active trigger mode is indicated by highlighting the corresponding softkey.

To indicate that a trigger mode other than *FREE RUN* has been set, the enhancement label **TRG** is displayed on the screen. If two windows are displayed, TRG appears next to the appropriate window.

TRIG

FREE RUN
VIDEO
EXTERN
POLARITY POS NEG

FREE RUN

The *FREE RUN* softkey activates the free-run sweep mode, i.e. start of a scan is not triggered. Once a measurement is completed, another is started immediately.

FREE RUN is the default setting of R&S ESCI.

Remote command: TRIG:SOUR IMM

VIDEO

The *VIDEO* softkey activates triggering via the displayed voltage.

For the video triggering mode, a level line showing the trigger threshold is displayed. Using the level line, the threshold can be adjusted between 0% and 100% of the diagram height.

Remote command: TRIG:SOUR VID
TRIG:LEV:VID 50 PCT

EXTERN

The *EXTERN* softkey activates triggering via a TTL signal at the input connector *EXT TRIGGER/GATE* on the rear panel.

Remote command: TRIG:SOUR EXT

**POLARITY
POS | NEG**

The *POLARITY POS/NEG* softkey selects the polarity of the trigger source.

The scan starts after a positive or negative edge of the trigger signal. The selected setting is highlighted.

The selection is valid for all trigger modes with the exception of *FREE RUN*.

The default setting is *POLARITY POS*.

Remote command: TRIG:SLOP POS

4.5.7 Marker Functions – MKR Key**MKR**

MARKER 1 2 3 4
MARKER NORM DELTA
MKR->TRACE
ALL MARKER OFF

**MARKER
1|2|3|4
MARKER
NORM | DELT
A**

The *MARKER 1|2|3|4* softkey selects the corresponding marker and activates it.

MARKER 1 is always the normal marker. After they have been switched on, *MARKERS 2 to 4* are delta markers that refer to *MARKER 1*. These markers can be converted into markers with absolute value display by means of the *MARKER NORM DELTA* softkey. When *MARKER 1* is the active marker, pressing the *MARKER NORM DELTA* softkey switches on an additional delta marker.

Pressing the *MARKER 1/2/3/4* softkey again switches off the selected marker.

Example:

[PRESET]	R&S ESCI is set to the default setting.
[MKR]	On calling the menu, <i>MARKER 1</i> is switched on ('1' highlighted in the softkey) and positioned on the maximum value of the trace. It is a normal marker and the <i>MARKER NORMAL</i> softkey is highlighted.
[MARKER 2]	<i>MARKER 2</i> is switched on ('2' highlighted in the softkey). It is automatically defined as a delta marker on switching on so the <i>DELTA</i> is highlighted on softkey <i>MARKER NORM DELTA</i> . The frequency and level of <i>MARKER 2</i> with reference to <i>MARKER 1</i> are output in the marker info field.
[MARKER NORM DELTA]	The <i>MARKER NORM DELTA</i> softkey is highlighted. <i>MARKER 2</i> becomes a normal marker. The frequency and level of <i>MARKER 2</i> are output as absolute values in the marker info field.
[MARKER 2]	<i>MARKER 2</i> is switched off. <i>MARKER 1</i> is the active marker for entry. The frequency and level of <i>MARKER 1</i> are output in the marker info field.
Remote command:	<pre> CALC:MARK ON; CALC:MARK:X <value>; CALC:MARK:Y? CALC:DELT ON; CALC:DELT:MODE ABS REL CALC:DELT:X <value>; CALC:DELT:X:REL? CALC:DELT:Y? </pre>

When several traces are being displayed, the marker is set to the maximum value (peak) of the active trace which has the lowest number (1 to 3). In case a marker is already located there, it will be set to the frequency of the next lowest level (next peak).

A marker can only be enabled when at least one trace in the corresponding window is visible.

If a trace is turned off, the corresponding markers and marker functions are also deactivated. If the trace is switched on again (*VIEW, CLR/WRITE;..*), the markers along with coupled functions will be restored to their original positions provided the markers have not been used on another trace.

MKR→TRACE The *MKR→TRACE* softkey places the marker on a new trace. The trace is selected via a data entry field. Only those traces can be selected which are visible on the screen in the same window.

The function of the softkey is identical to the *MKR*→*TRACE* softkey in the *MKR FCNT* and *MKR*→ menu.

Example:

Three traces are presented on the screen. The marker is always on Trace 1 on switching on.

[*MKR* →*TRACE*] "2"

The marker jumps to Trace 2 but remains on the previous frequency or time.

[*MKR* →*TRACE*] "3"

The marker jumps to Trace 3.

Remote command: *CALC:MARK1:TRAC 1*
 CALC:DELT:TRAC 1

**ALL MARKER
OFF**

Pressing the *ALL MARKER OFF* softkey switches off all marker.

4.5.8 Change of Settings via Markers – MKR-> Key

The *MKR->* menu offers functions through which instrument parameters can be changed with the aid of the currently active marker. The functions can be used on markers and delta markers.

On opening the menu, the entry for the last active marker is activated; if no marker was enabled, *MARKER 1* is activated and a peak search is performed.

MKR->

SELECT MARKER	
PEAK	
NEXT PEAK	
NEXT PEAK RIGHT	
NEXT PEAK LEFT	
ADD TO PEAK LIST	
TUNE TO MARKER	
MARKER TRACK	
MKR->TRACE	
Side menu	
MKR-> STEPSIZE	
MIN	
NEXT MIN	
NEXT MIN RIGHT	
NEXT MIN LEFT	
SETTINGS COUPLED	
SEARCH LIMITS↓	LEFT LIMIT RIGHT LIMIT
	THRESHOLD
	SEARCH LIMIT OFF
PEAK EXCURSION	

SELECT MARKER

The *SELECT MARKER* softkey activates the numerical selection of the marker in the data entry field. If no marker is active when *MKR->* menu is called, *MARKER 1* is automatically switched on. Delta marker 1 is selected by input of '0'.

Remote command: `CALC:MARK1 ON;`
 `CALC:MARK1:X <value>;`
 `CALC:MARK1:Y?`

- PEAK** The *PEAK* softkey sets the active marker or delta marker to the peak of the trace. If no marker is active when *MKR->* menu is called, *MARKER 1* is automatically switched on and the peak search is performed.
- Remote command: `CALC:MARK:MAX`
 `CALC:DELT:MAX`
- NEXT PEAK** The *NEXT PEAK* softkey sets the active marker/delta marker to the next lower peak value on the trace. The search direction is defined in the *NEXT MODE* submenu (see analyzer mode).
- Remote command: `CALC:MARK:MAX:NEXT`
 `CALC:DELT:MAX:NEXT`
- NEXT PEAK RIGHT** The *NEXT PEAK RIGHT* softkey sets the active marker/delta marker to the next lower peak value to the right side of the current marker position on the selected trace.
- Remote command: `CALC:MARK:MAX:RIGH`
 `CALC:DELT:MAX:RIGH`
- NEXT PEAK LEFT** The *NEXT PEAK LEFT* softkey sets the active marker/delta marker to the next lower peak value to the left side of the current marker position on the trace.
- Remote command: `CALC:MARK:MAX:LEFT`
 `CALC:DELT:MAX:LEFT`
- ADD TO PEAK LIST** The *ADD TO PEAK LIST* softkey adds the frequency of the current marker to the peak list (see also section [“Data Reduction and Peak List” on page 4.31](#)).
- Remote command: `--`
- TUNE TO MARKER** The *TUNE TO MARKER* softkey sets the receiver frequency to the marker frequency.
- Remote command: `:CALC:MARK:FUNC:CENT`
- MARKER TRACK** The *MARKER TRACK* softkey couples the current receive frequency to the marker frequency.
- Remote command: `:CALC:MARK:COUP ON`
- MKR->TRACE** The *MKR->TRACE* softkey places the marker on a new trace. The trace is selected via a data entry field. Only those traces can be selected which are visible on the screen in the same window.
- The function of the softkey is identical to the *MKR->TRACE* softkey in the *MKR FCNT* and *MKR* menu.
- Example:**
- Three traces are presented on the screen. The marker is always on Trace 1 on switching on.
- `[MKR ->TRACE] "2"`
- The marker jumps to Trace 2 but remains on the previous frequency or time.

[MKR ->TRACE] "3"

The marker jumps to Trace 3.

Remote command: CALC:MARK1:TRAC 1
 CALC:DELT:TRAC 1

MKR-> STEPSIZE

The *MKR->STEPSIZE* softkey sets the step size for the receiver frequency variation to the current marker frequency, and also sets step size adaptation to *MANUAL*. *STEPSIZE* remains at this value until the receiver frequency entry mode in the *STEPSIZE* menu is switched from *MANUAL* to *AUTO* again.

The *MKR->STEPSIZE* function is, above all, useful in the measurement of harmonics.

Remote command: CALC:MARK:FUNC:CST

MIN

The *MIN* softkey sets the active marker to the minimum value on the corresponding trace.

Remote command: CALC:MARK:MIN
 CALC:DELT:MIN

NEXT MIN

The *NEXT MIN* softkey sets the active marker/delta marker to the next higher minimum of the selected trace. The search direction is defined in the *NEXT MODE* submenu (see below).

Remote command: CALC:MARK:MIN:NEXT
 CALC:DELT:MIN:NEXT

NEXT MIN RIGHT

The *NEXT MIN RIGHT* softkey sets the active marker/delta marker to the next higher minimum value to the right of the current marker position on the corresponding trace.

Remote command: CALC:MARK:MIN:RIGH
 CALC:DELT:MIN:RIGH

NEXT MIN LEFT

The *NEXT MIN LEFT* softkey sets the active marker/delta marker to the next higher minimum value to the left of the current marker position on the corresponding trace.

Remote command: CALC:MARK:MIN:LEFT
 CALC:DELT:MIN:LEFT

SETTINGS COUPLED

The *SETTINGS COUPLED* softkey couples the receiver frequency settings from the corresponding subscreens to the marker frequency for functions *TUNE TO MARKER* and *MARKER TRACK*.

Remote command: :CALC:MARK:SCO ON

SEARCH LIMITS

The *SEARCH LIMITS* softkey limits the search range for maximum or minimum search. The softkey switches to a submenu in which the search range limits can be set in the x and y direction.

LEFT LIMIT RIGHT LIMIT
THRESHOLD
SEARCH LIMIT OFF

LEFT LIMIT
RIGHT LIMIT The *LEFT LIMIT* and *RIGHT LIMIT* softkeys define the two vertical lines F1 and F2 in the frequency domain (span > 0) and T1 / T2 in the time domain (span = 0). The search is performed between these lines in the frequency and time domain.

If only *LEFT LIMIT* is enabled, line F1/T1 is the lower limit and the upper limit corresponds to the stop frequency. If *RIGHT LIMIT* is also enabled, it determines the upper limit.

Remote command: `CALC:MARK:X:SLIM:LEFT 1MHZ`
 `CALC:MARK:X:SLIM:RIGH 10MHZ`
 `CALC:MARK:X:SLIM ON`

THRESHOLD The *THRESHOLD* softkey defines the threshold line.

The threshold line represents a limit for the level range of the max. search at the lower end and that of the min. search at the upper end.

Remote command: `CALC:THR -20dBm`
 `CALC:THR ON`

SEARCH LIMIT
OFF The *SEARCH LIMIT OFF* softkey disables all limits of the search range.

Remote command: `CALC:MARK:X:SLIM OFF`
 `CALC:THR OFF`

PEAK **EXCURSION**

The *PEAK EXCURSION* softkey activates an entry box for selecting the minimum amount by which a signal level must decrease/increase before it is recognized by the *NEXT PEAK* and *NEXT MIN* search functions as a maximum or minimum.

Input values from 0 to 80 dB are allowed, the resolution being 0.1 dB.

Remote command: `CALC:MARK:PEXC 10dB`

For detailed explanation see softkey *PEAK EXCURSION* in *ANALYZER* mode.

4.5.9 Marker Functions – MKR FCTN Key

MKR FCNT

SELECT MARKER
PEAK
MARKER ZOOM
PREV ZOOM RANGE
ZOOM OFF
MKR->TRACE

On calling the menu, the entry for the last active marker is activated (*SELECT MARKER* softkey); if no marker is activated, marker 1 is activated and a maximum search (*PEAK* softkey) is performed. The marker can be set to the desired trace by means of *MKR -> TRACE* softkey.

**SELECT
MARKER**

The *SELECT MARKER* softkey activates the numerical selection of the marker in the data entry field. Delta marker 1 is selected by input of ' 0 '.

If the marker is switched off, then it is switched on and can be moved later on.

Remote command: `CALC:MARK1 ON;`
 `CALC:MARK1:X <value>;`
 `CALC:MARK1:Y?`

PEAK

The *PEAK* softkey sets the active marker/delta marker to the peak of the trace.

Remote command: `CALC:MARK1:MAX`
 `CALC:DELT1:MAX`

**MARKER
ZOOM**

The *MARKER ZOOM* softkey zooms 10% of the diagram around the current marker. At the same time a data entry field opens which allows to enter any frequency range which is then displayed.

Pressing the softkey again expands the diagram until only 3 measured values are represented.

Remote command: `:CALC:MARK:FUNC:ZOOM <num_value>`

**PREV ZOOM
RANGE**

The *PREV ZOOM RANGE* softkey sets again the previous frequency range.

Remote command: `--`

**ZOOM
OFF**

The *ZOOM OFF* softkey switches off the zoomed representation.

Remote command: `:DISP:TRAC:X:ZOOM OFF`

MKR->TRACE

The *MKR->TRACE* softkey places the marker on a new trace. The trace is selected via a data entry field. Only those traces can be selected which are visible on the screen in the same window.

The function of the softkey is identical to the *MKR->TRACE* softkey in the MKR and MKR-> menu.

Example:

Three traces are presented on the screen. The marker is always on Trace 1 on switching on.

`[MKR ->TRACE] "2"`

The marker jumps to Trace 2 but remains on the previous frequency or time.

`[MKR ->TRACE] "3"`

The marker jumps to Trace 3.

Remote command: `CALC:MARK1:TRAC 1`
 `CALC:DELT:TRAC 1`

4.5.10 Selection and Setting of Traces – TRACE Key

The R&S ESCI is capable of displaying up to three different traces at a time in a diagram. A displayed trace consists of a maximum of 501 pixels on the horizontal axis (frequency or time). If more measured values than pixels are available, several measured values are combined in one pixel.

The R&S ESCI stores up to a million measured values per trace for a frequency scan and up to 1.44 million measured values per trace for a scan on a fixed frequency (time domain) in its internal memory.

The traces are selected using the *SELECT TRACE* softkey in the menu of the *TRACE* key.

The traces can individually be activated for a measurement or frozen after completion of a measurement. Traces that are not activated are blanked.

The display mode can be selected for each trace. Traces can be overwritten in each measurement (CLEAR/WRITE mode), averaged over several measurements (AVERAGE mode), or a maximum or minimum value can be determined from several measurements and displayed (MAX HOLD or MIN HOLD).

Individual detectors can be selected for the various traces. The max peak detector and min peak detector display the maximum and minimum value of the level within a pixel. The rms detector displays the power (rms value) of the measured values within a pixel, the average detector the average value.

The quasipeak detector yields the level weighted to CISPR 16.

4.5.10.1 Selection of Trace Function

The trace functions are subdivided as follows:

- Display mode of trace (CLEAR/WRITE, VIEW and BLANK)
- Evaluation of the trace as a whole (AVERAGE, MAX HOLD and MIN HOLD)
- Evaluation of individual pixels of a trace (MAX PEAK, MIN PEAK, QUASPEAK, AVERAGE and RMS).

TRACE

SELECT TRACE	
CLEAR/ WRITE	
MAX HOLD	
VIEW	
BLANK	
SCAN COUNT	
DETECTOR⇩	MAX PEAK
	MIN PEAK
	QUASPEAK
	AVERAGE
	RMS
	Side menu
	FINAL MAX PEAK

	FINAL MIN PEAK
	FINAL QUASISPEAK
	FINAL AVERAGE
	FINAL CISPR AV
	FINAL RMS
	FINAL CISPR RMS
PEAK LIST ON OFF	
Side menu	
MIN HOLD	
ASCII FILE EXPORT	
DECIM SEP	
COPY TRACE	

The *TRACE* key opens a menu offering the setting options for the selected trace.

In this menu, the mode of representing the measured data in the frequency or time domain in the 501 pixels of the display is determined. Upon start of the measurement, each trace can be displayed either completely new or based on the previous results.

Traces can be displayed, blanked and copied.

The measurement detector for the individual display modes can be selected directly by the user.

The default setting is trace 1 in the overwrite mode (*CLEAR / WRITE*) and detector *MAX PEAK* is selected, trace 2 is also in the overwrite mode (*CLEAR / WRITE*) and detector *AVERAGE* is selected, trace 3 is switched off (*BLANK*).

The *CLEAR/WRITE*, *MAX HOLD*, *MIN HOLD*, *AVERAGE*, *VIEW* and *BLANK* softkeys are mutually exclusive selection keys.

SELECT TRACE

The *SELECT TRACE* softkey activates the entry for the active trace (1, 2, 3).

Remote command: -- (selected via numeric suffix of : TRACe)

CLEAR/ WRITE

The *CLEAR/WRITE* softkey activates the overwrite mode for the collected measured values, i.e. the trace is overwritten by each sweep.

Each time the *CLEAR/WRITE* softkey is actuated, R&S ESCI clears the selected trace memory and starts the measurement anew.

Remote command: DISP:WIND:TRAC:MODE WRIT

MAX HOLD

The *MAX HOLD* softkey activates the max peak detector.

R&S ESCI saves the sweep result in the trace memory only if the new value is greater than the previous one.

This is especially useful with modulated or impulsive signals. The signal spectrum is filled up upon each scan until all signal components are detected in a kind of envelope.

Pressing the *MAX HOLD* softkey again clears the trace memory and restarts the max hold mode.

Remote command: `DISP:WIND:TRAC:MODE MAXH`

VIEW

The *VIEW* softkey freezes the current contents of the trace memory and displays it.

If in the *VIEW* display mode the level display range (*GRID RANGE*) or the reference level (*GRID MIN LEVEL*) are changed, R&S ESCI automatically adapts the measured data to the changed display range. This allows an amplitude zoom to be made after the measurement in order to show details of the trace.

Remote command: `DISP:WIND:TRAC:MODE VIEW`

BLANK

The *BLANK* softkey activates the blanking of the trace on the screen.

Remote command: `DISP:WIND:TRAC OFF`

SCAN COUNT

The *SCAN COUNT* softkey activates the entry of the number of scan used in the SINGLE SCAN mode.

The allowed range of values is 0 to 30000. The default setting is 1.

Remote command: `SWE:COUN 10`

DETECTOR

The *DETECTOR* softkey opens a submenu to select the detector.

The detector type is set for the trace scan and may be independently selected for each trace.

For description of detector types see section [“Selection of Detector” on page 4.108](#).

MAX PEAK

The *MAX PEAK* softkey activates the max peak detector.

Remote command: `DET POS`

MIN PEAK

The *MIN PEAK* softkey activates the min peak detector.

Remote command: `DET NEG`

QUASIPeAK

The *QUASIPeAK* softkey selects the quasipeak detector.

The IF bandwidth is adapted as a function of the frequency range. The coupling of the IF bandwidth to the frequency range can be cancelled using softkey *CISPR RBW UNCOUPLED*.

Remote command: `DET QPE`

AVERAGE

The *AVERAGE* softkey activates the average detector.

Remote command: `DET AVER`

RMS

The *RMS* softkey activates the rms detector.

Remote command: `:DET RMS`

FINAL MAX PEAK	The <i>FINAL MAX PEAK</i> selects the max peak detector for the final measurement. Remote command: :DET:FME POS
FINAL MIN PEAK	The <i>FINAL MIN PEAK</i> selects the min peak detector for the final measurement. Remote command: :DET:FME NEG
FINAL QUASIPeAK	The <i>FINAL QUASIPeAK</i> selects the quasipeak detector for the final measurement. Remote command: :DET:FME QPE
FINAL AVERAGE	The <i>FINAL AVERAGE</i> selects the average detector for the final measurement. Remote command: :DET:FME AVER
FINAL CISPR AV	The <i>FINAL CISPR AV</i> selects the weighting average detector according to CISPR 16-1 for the final measurement. Remote command: :DET:FME CAV
FINAL RMS	The <i>FINAL RMS</i> selects the rms detector for the final measurement. Remote command: :DET:FME RMS
FINAL CISPR RMS	The <i>FINAL CISPR RMS</i> softkey selects the weighting rms detector according to CISPR 16-1-1 for the final measurement. Remote command: :DET:FME CRMS
PEAK LIST ON OFF	The <i>PEAK LIST ON / OFF</i> softkey switches on and off the indication of the peak list or of the final measurement results. The single value is indicated as + or x. The assignment of symbol to trace is fixed. <i>RUN SCAN</i> automatically switches <i>PEAK LIST</i> to <i>OFF</i> in order to prevent the indication of preceding final measurement results. <i>PEAK SEARCH</i> automatically sets <i>PEAK LIST</i> to <i>ON</i> (see “Data Reduction and Peak List” on page 4.31). Remote command: DISP:TRAC:SYMB CROS OFF
MIN HOLD	The <i>MIN HOLD softkey</i> activates the min peak detector. <i>R&S ESCI</i> saves for each scan the smallest of the previously stored/currently measured values in the trace memory. This function is useful e.g. for making an unmodulated carrier in a composite signal visible. Noise, interference signals or modulated signals are suppressed by the min hold function whereas a CW signal is recognized by its constant level. Pressing the <i>MIN HOLD</i> softkey again clears the trace memory and restarts the min hold function. Remote command: DISP:WIND:TRAC:MODE MINH
ASCII FILE EXPORT	The <i>ASCII FILE EXPORT</i> softkey stores the active trace in ASCII format on a USB device or, if available, a floppy disk. Remote command: FORM ASC; MMEM:STOR:TRAC 1, 'TRACE.DAT'

The file consists of the header containing important scaling parameters, several data sections containing the scan settings and a data section containing the trace data.

The data of the file header consist of three columns, each separated by a semicolon:

parameter name; numeric value; base unit

The data section for the scan ranges starts with the keyword "Scan <n>:", (<n> = number of scan range), followed by the scan data in one or several columns which are also separated by a semicolon.

The data section for the trace data starts with the keyword " Trace <n> " (<n> = number of stored trace), followed by the measured data in one or several columns which are also separated by a semicolon.

This format can be read in from spreadsheet calculation programs, e.g. MS Excel. It is necessary to define ';' as a separator.



Different language versions of evaluation programs may require a different handling of the decimal point. It is therefore possible to select between separators '.' (decimal point) and ',' (comma) using softkey *DECIM SEP*.

Table 4-1 Example – File header:

File contents	Description
Type;R&S ESCI	Instrument model
Version;1.00;	Firmware version
Date;10.Nov 08;	Date of data set storage
Mode;Receiver;	Instrument mode
Start;150000.000000;Hz Stop;1000000000.000000;Hz	Start/stop of the display range. Unit: Hz
x-Axis;LOG;	Scaling of x-axis linear (LIN) or logarithmic (LOG)
Detector;AVERAGE;	Selected detector MAXPEAK, MINPEAK, AVERAGE, RMS, QUASPEAK
Scan Count;1;	Scan count
Transducer;;	Transducer name (if switched on)

Table 4-2 Example – Data section of the file, Scan ranges

File contents	Description
Scan 1:	Settings for scan range 1
Start;150000.000000;Hz	Range 1 - start frequency in Hz
Stop;30000000.000000;Hz	Range 1 – stop frequency in Hz
Step; 4000.000000;Hz	Range 1 - step size
RBW;9000.000000;Hz	Range 1 - resolution bandwidth
Meas Time;0.001000;s	Range 1 - measurement time
Auto Ranging;OFF;	Range 1 - Auto ranging on - or off

File contents	Description
RF Att;10.000000;dB	Range 1 - input attenuation
Auto Preamp;OFF;	Range 1 - Auto Preamp on or off
Preamp;0.000000;dB	Range 1 - preamplifier on (20dB) or off (0dB)
Scan 2:	Settings for scan range 2
Start;30000000.000000;Hz	Range 2 - start frequency in Hz
Stop;1000000000.000000;Hz	Range 2 - stop frequency in Hz
Step; 50000.000000;Hz	Range 2 - step width
RBW;120000.000000;Hz	Range 2 - resolution bandwidth
Meas Time;0.000100;s	Range 2 - measurement time
Auto Ranging;OFF;	Range 2 - Auto ranging on - or off
RF Att;10.000000;dB	Range 2 - input attenuation
Auto Preamp;OFF;	Range 2 - Auto Preamp on or off
Preamp;0.000000;dB	Range 2 - preamplifier on (20dB) or off (0dB)

Table 4-3 Example – Data section of the file, Trace

File contents	Description
Trace 1:	Selected trace
Trace Mode;CLR/WRITE;	Trace mode: CLR/WRITE, MAXHOLD
x-Unit;Hz;	Unit of x values: Hz for span > 0
y-Unit;dB μ V;	Unit of y values: dB*/V/A/W depending on the selected unit
Values;26863;	Number of test points
150000.000000;15.604355; 154000.000000;13.236252; 158000.000000;11.907021; ...;...	Measured values: <x value>, <y value>;

DECIM SEP

The *DECIM SEP* softkey selects the decimal separator between '.' (decimal point) and ',' (comma) with floating-point numerals for the function ASCII FILE EXPORT.

With the selection of the decimal separator different language versions of evaluation programs (e.g. MS Excel) can be supported.

Remote command: `FORM:DEXP:DSEP POIN`

COPY TRACE

The *COPY TRACE* softkey copies the screen contents of the current trace into another trace memory. The desired memory is selected by entering the number 1, 2 or 3.

Upon copying, the contents of the selected memory are overwritten and the new contents displayed in view mode.

Remote command: `TRAC:COPY TRACE1,TRACE2`

4.6 Analyzer Mode

The analyzer mode is activated by pressing the *SPECTRUM* hotkey (see also section “Mode Selection – Hotkey Bar” on page 4.9)

SPECTRUM

The *SPECTRUM* hotkey selects the mode for spectrum analysis, the so-called analyzer mode.

The functions provided correspond to those of a conventional spectrum analyzer. The R&S ESCI measures the frequency spectrum of the test signal over the selected frequency range with the selected resolution and sweep time, or, for a fixed frequency, displays the waveform of the video signal.



If two displays (screen A and screen B) are opened after switch-on of signal analysis, the analyzer mode is only set for the display activated for entry (marked at the top right corner of diagram). For the other display, the previous settings remain valid.

Data acquisition and display of measured values is sequential: first in the upper and then in the lower display.

4.6.1 Frequency and Span Selection – **FREQ** Key

The *FREQ* key is used to specify the frequency axis of the active display window. The frequency axis can be defined either by the start and stop frequency or by the center frequency and the span (*SPAN* key). With two windows (*SPLIT SCREEN*) displayed at the same time, the input data always refer to the window selected in the *SYSTEM - DISPLAY* menu.

The softkeys in the *CF STEPSIZE* menu depend on the selected domain: frequency domain or time domain.

FREQ

CENTER	
CF STEPSIZE ↓	0.1 * SPAN / 0.1 * RBW
	0.5 * SPAN / 0.5 * RBW
	X * SPAN / X * RBW
	= CENTER
	= MARKER
	MANUAL
START	
STOP	
FREQUENCY OFFSET	
SIGNAL TRACK ↓	TRACK ON/OFF
	TRACK BW
	TRACK THRESHOLD
	SELECT TRACE

CENTER The *CENTER* softkey opens the window for manually entering the center frequency.

The allowed range of values for the center frequency is:

- for the frequency domain (span >0):

$$\text{minspan} / 2 \leq f_{\text{center}} \leq f_{\text{max}} - \text{minspan} / 2$$

- and for the time domain (span = 0):

$$0 \text{ Hz} \leq f_{\text{center}} \leq f_{\text{max}}$$

f_{center} center frequency

minspan smallest selectable span > 0 Hz (10 Hz)

f_{max} max. frequency

Remote command: `FREQ:CENT 100MHz`

CF STEPSIZE The *CF STEPSIZE* softkey opens a submenu for setting the step size of the center frequency. The step size can be coupled to the span (frequency domain) or the resolution bandwidth (time domain) or it can be manually set to a fixed value. The softkeys are mutually exclusive selection keys.

The softkeys are presented according to the selected domain (frequency or time).

Softkeys in frequency domain:

0.1 * SPAN The *0.1 * SPAN* softkey sets the step size for the center frequency entry to 10% of the span.

Remote command: `FREQ:CENT:STEP:LINK SPAN`
`FREQ:CENT:STEP:LINK:FACT 10PCT`

0.5 * SPAN The *0.5 * SPAN* softkey sets the step size for the center frequency entry to 50% of the span.

Remote command: `FREQ:CENT:STEP:LINK SPAN`
`FREQ:CENT:STEP:LINK:FACT 50PCT`

X * SPAN The *X * SPAN* softkey allows the factor defining the center frequency step size to be entered as % of the span.

Remote command: `FREQ:CENT:STEP:LINK SPAN`
`FREQ:CENT:STEP:LINK:FACT 20PCT`

= CENTER The *= CENTER* softkey sets the step size coupling to MANUAL and the step size to the value of the center frequency. This function is especially useful during measurements of the signal harmonic content because by entering the center frequency each stroke of the *STEP* key selects the center frequency of another harmonic.

Remote command: `--`

= MARKER The *= MARKER* softkey sets the step size coupling to MANUAL and the step size to the value of the marker. This function is especially useful during measurements of the signal harmonic content at the marker position because by entering the center frequency each stroke of the *STEP* key selects the center frequency of another harmonic.

Remote command: `--`

MANUAL The *MANUAL* softkey activates the window for entering a fixed step size.

Remote command: `FREQ:CENT:STEP 120MHz`

Softkeys in time domain:

0.1 * RBW The *0.1 * RBW* softkey sets the step size for the center frequency entry to 10% of the resolution bandwidth.

*AUTO 0.1 * RBW* corresponds to the default setting.

Remote command: `FREQ:CENT:STEP:LINK RBW`
`FREQ:CENT:STEP:LINK:FACT 10PCT`

0.5 * RBW The *0.5 * RBW* softkey sets the step size for the center frequency entry to 50% of the resolution bandwidth.

Remote command: `FREQ:CENT:STEP:LINK RBW`
`FREQ:CENT:STEP:LINK:FACT 50PCT`

X * RBW The *X * RBW* softkey allows the factor defining the center frequency step size to be entered as % of the resolution bandwidth.

Values between 1 and 100% in steps of 1% are allowed. The default setting is 10%.

Remote command: `FREQ:CENT:STEP:LINK RBW`
`FREQ:CENT:STEP:LINK:FACT 20PCT`

= CENTER The *= CENTER* softkey sets the step size coupling to *MANUAL* and the step size to the value of the center frequency. This function is especially useful during measurements of the signal harmonic content because by entering the center frequency each stroke of the *STEP* key selects the center frequency of another harmonic.

Remote command: `--`

= MARKER The *= MARKER* softkey sets the step size coupling to *MANUAL* and the step size to the value of the marker. This function is especially useful during measurements of the signal harmonic content at the marker position because by entering the center frequency each stroke of the *STEP* key selects the center frequency of another harmonic.

Remote command: `--`

MANUAL The *MANUAL* softkey activates the window for entering a fixed step size.

Remote command: `FREQ:CENT:STEP 120MHz`

START The *START* softkey activates the window for manually entering the start frequency. The allowed range of values for the start frequency is:

$$0 \text{ Hz} \leq f_{\text{start}} \leq f_{\text{max}} - \text{minspan}$$

f_{start} start frequency

minspan smallest selectable span (10 Hz)

f_{max} max. frequency

Remote command: `FREQ:STAR 20MHz`

STOP	<p>The <i>STOP</i> softkey activates the window for entering the stop frequency.</p> <p>The allowed range of values for the stop frequency is:</p> $\text{minspan} \leq f_{\text{stop}} \leq f_{\text{max}}$ <p>f_{stop} stop frequency minspan smallest selectable span (10 Hz) f_{max} max. frequency</p> <p>Remote command: <code>FREQ:STOP 2000MHz</code></p>
FREQUENCY OFFSET	<p>The <i>FREQUENCY OFFSET</i> softkey activates the window for entering an arithmetical frequency offset which is added to the frequency axis labelling. The allowed range of values for the offset is -100 GHz to 100 GHz. The default setting is 0 Hz.</p> <p>Remote command: <code>FREQ:OFFS 10 MHz</code></p>
SIGNAL TRACK	<p>The <i>SIGNAL TRACK</i> softkey switches on the tracking of a signal near the center frequency. The signal is tracked as long it is in the search bandwidth around the center frequency defined with <i>TRACK BW</i> and above the level threshold defined with <i>TRACK THRESHOLD</i>.</p> <p>For that purpose, the maximum signal is searched (<i>PEAK SEARCH</i>) on the screen and the center frequency set to this signal (<i>MARKER ->CENTER</i>) after each frequency sweep within the search bandwidth.</p> <p>If the signal falls below the level threshold or jumps out of the search bandwidth around the center frequency, the center frequency is not varied until a signal is in the search bandwidth above the level threshold. This can be achieved by manually modifying the center frequency, for example.</p> <p>On switching on, the softkey is highlighted and the search bandwidth and the threshold value are marked on the diagram by two vertical lines and one horizontal line. All these lines are provided with the designation TRK.</p> <p>At the same time a submenu is opened in which the search bandwidth, the threshold value and the trace can be modified for the maximum search.</p> <p>The softkey is only available in the frequency domain (span >0).</p> <p>Remote command: <code>CALC:MARK:FUNC:STR OFF</code></p>
TRACK ON/OFF	<p>The <i>TRACK ON/OFF</i> softkey switches on and off signal tracking.</p> <p>Remote command: <code>CALC:MARK:FUNC:STR OFF</code></p>
TRACK BW	<p>The <i>TRACK BW</i> softkey defines the search bandwidth for signal tracking. The frequency range is symmetrical with respect to the center frequency.</p> <p>Remote command: <code>CALC:MARK:FUNC:STR:BAND 10KHZ</code></p>
TRACK THRESHOLD	<p>The <i>TRACK THRESHOLD</i> softkey defines the threshold value for signal detection. The value is always entered as an absolute level value.</p> <p>Remote command: <code>CALC:MARK:FUNC:STR:THR -70DBM</code></p>

SELECT TRACE The *SELECT TRACE* softkey selects the trace on which signal tracking is to be performed.

Remote command: `CALC:MARK:FUNC:STR:TRAC 1`

4.6.2 Setting the Frequency Span – SPAN Key

The *SPAN* key opens a menu which offers various options for setting the span.

The entry of the span (*SPAN MANUAL* softkey) is automatically active for span > 0 Hz.

For span = 0 Hz the entry for sweep time (*SWEEPTIME MANUAL*) is automatically active.

With two windows (*SPLIT SCREEN*) displayed at the same time, the input data always refer to the window selected with the *SCREEN A/B* hotkey.

SPAN

SPAN MANUAL
SWEEPTIME MANUAL
FULL SPAN
ZERO SPAN
LAST SPAN
FREQ AXIS LIN LOG

SPAN MANUAL

The *SPAN MANUAL* softkey activates the window for manually entering the frequency span. The center frequency is kept constant.

Allowed range of span values:

- for the time domain (span = 0): 0 Hz
- and for the frequency domain (span >0): $\text{minspan} \leq f_{\text{span}} \leq f_{\text{max}}$

f_{span} frequency span
 minspan smallest selectable span (10 Hz)
 f_{max} max. frequency

Remote command: `FREQ:SPAN 2GHz`

SWEEPTIME MANUAL

The *SWEEPTIME MANUAL* softkey activates the window for entering the sweep time manually with Span = 0 Hz. The softkey is not available for Span > 0 Hz.

Remote command: `SWE:TIME 10s`

FULL SPAN

The *FULL SPAN* softkey sets the span to the full frequency range of R&S ESCI.

Remote command: `FREQ:SPAN:FULL`

ZERO SPAN

The *ZERO SPAN* softkey sets the span to 0 Hz. The x-axis becomes the time axis with the grid lines corresponding to 1/10 of the current sweep time (SWT).

Remote command: `FREQ:SPAN 0Hz`

LAST SPAN

After changing the span setting the *LAST SPAN* softkey activates the previous setting. With this function a fast change between overview measurement (*FULL SPAN*) and detailed measurement (manually set center frequency and span) is possible.



Only values > 0 Hz are restored, i.e. a transition between time and frequency domain is not possible.

Remote command: --

**FREQ AXIS
LIN | LOG**

The *FREQ AXIS LIN | LOG* softkey switches between linear and logarithmic scaling of the frequency axis. Switch over is only possible if the stop/start frequency ratio is ≥ 1.4 .

The default state is LIN.

The logarithmic frequency axis is only available in analyzer mode and it is not available in zero span mode, in external mixer mode, with frequency offset or if the ratio stop frequency / start frequency is below 1.4.

Remote command: DISP:WIND<1|2>:TRAC:X:SPAC LIN

4.6.3 Level Display Setting and RF Input Configuration – AMPT Key

The *AMPT* key is used to set the reference level, the maximum level and the display range of the active window as well as the input impedance and the input attenuation of the RF input.

The *AMPT* key opens a menu for setting the reference level and the input attenuation of the active window. The data entry for the reference level (*REF LEVEL* softkey) is opened automatically.

Further settings regarding level display and attenuation can be made in this menu.

AMPT

REF LEVEL	
RANGE LOG 100 dB	
RANGE LOG MANUAL	
RANGE LINEAR ↓	RANGE LINEAR %
	RANGE LINEAR dB
UNIT ↓	dBm / dBmV / dBμV / dBμA / dBμW / VOLT / AMPERE / WATT
RF INPUT AC/DC	
RF ATTEN MANUAL	
RF ATTEN AUTO	
10 dB MIN ON/OFF	
Side menu	
REF LEVEL POSITION	

REF LEVEL OFFSET	
GRID ABS REL	
RF INPUT 50 Ohm 75 Ohm	

REF LEVEL The *REF LEVEL* softkey allows the reference level to be input in the currently active unit (dBm, dB μ V, etc.)

Remote command: `DISP:WIND:TRAC:Y:RLEV -60dBm`

RANGE LOG 100 dB The *RANGE LOG 100 dB* softkey sets the level display range to 100 dB.

Remote command: `DISP:WIND:TRAC:Y:SPAC LOG`
`DISP:WIND:TRAC:Y 100DB`

RANGE LOG MANUAL The *RANGE LOG MANUAL* softkey activates the manual entry of the level display range. Display ranges from 1 to 200 dB are allowed in 10 dB steps. Inputs which are not allowed are rounded to the next valid value.

The default setting is 100 dB.

Remote command: `DISP:WIND:TRAC:Y:SPAC LOG`
`DISP:WIND:TRAC:Y 120DB`

RANGE LINEAR The *RANGE LINEAR* softkey selects linear scaling for the level display range of the R&S ESCI. In addition, it opens a submenu for selecting % or dB for the scaling.

When linear scaling is selected, the % scaling is first activated (see also *RANGE LINEAR dB* softkey).

Remote command: `DISP:WIND:TRAC:Y:SPAC LIN`

RANGE LINEAR % The *RANGE LINEAR %* softkey selects linear scaling in % for the level display range, i.e. the horizontal lines are labelled in %. The grid is divided in decadic steps. Markers are displayed in the selected unit; delta markers are displayed in % referenced to the voltage value at the position of marker 1.

Remote command: `DISP:WIND:TRAC:Y:SPAC LIN`

RANGE LINEAR dB The *RANGE LINEAR dB* softkey selects linear scaling in dB for the level display range, i.e. the horizontal lines are labelled in dB.

Markers are displayed in the selected unit; delta markers are displayed in dB referenced to the power value at the position of marker 1.

Remote command: `DISP:WIND:TRAC:Y:SPAC LDB`

UNIT

dBm
dBmV
dB μ V
dB μ A
dB μ W
VOLT

AMPERE
WATT

The *UNIT* softkey opens a submenu to select the unit for the level axis.

The default setting is dBm.

In general, the R&S ESCI measures the signal voltage at the RF input. The level display is calibrated in rms values of an unmodulated sinewave signal. In the default state, the level is displayed at a power of 1 mW (= dBm). Via the known input resistance of 50 Ω or 75W, conversion to other units is possible. The units dBm, dBmV, dB μ V, dB μ A, dBpW, V, A and W are directly convertible.

Remote command: `CALC:UNIT:POW DBM`

RF INPUT AC/ DC

The *RF INPUT AC/DC* softkey toggles the RF input of the R&S ESCI between AC and DC coupling.

Remote command: `INP:COUP AC`

RF ATTEN MANUAL

The *RF ATTEN MANUAL* softkey allows the attenuation to be entered irrespective of the reference level.

The attenuation can be set in 5 dB steps between 0 and 75 dB.

Other entries will be rounded to the next higher integer value.

If the defined reference level cannot be set for the given RF attenuation, the reference level will be adjusted accordingly and the warning "Limit reached" will be output.



The value 0 dB cannot be switched on unless the *10 dB MIN ON/OFF* softkey is set to *OFF* in order to protect the input mixer against accidental overload.

Remote command: `INP:ATT 40 DB`

RF ATTEN AUTO

The *RF ATTEN AUTO* softkey sets the RF attenuation automatically as a function of the selected reference level.

This ensures that the optimum RF attenuation desired by the user is always used.

RF ATTEN AUTO is the default setting.

Remote command: `INP:ATT:AUTO ON`

10 dB MIN ON/ OFF

The *10 dB MIN ON/OFF* softkey determines whether or not the 0 dB position of the attenuator is used when the attenuation is set manually or automatically.

The default setting is *ON*. This means the R&S ESCI always leaves at least 10 dB RF attenuation on in order to protect the input mixer.

The 0 dB position cannot be switched on manually. This prevents that 0 dB are set by mistake especially for measurements on objects with high signal voltage.

Remote command: `INP:ATT:PROT ON`

REF LEVEL POSITION

The *REF LEVEL POSITION* softkey allows the reference level position to be entered.

The setting range is from -200 to +200%, 0% corresponding to the lower and 100% to the upper limit of the diagram.

Remote command: `DISP:WIND:TRAC:RPOS 100PCT`

REF LEVEL OFFSET

The *REF LEVEL OFFSET* softkey allows the arithmetic level offset to be entered. This offset is added to the measured level irrespective of the selected unit. The scaling of the y-axis is changed accordingly.

The setting range is ± 200 dB in 0.1 dB steps.

Remote command: `DISP:WIND:TRAC:RLEV:OFFS -10dB`

Remote command:**GRID ABS | REL**

The *GRID ABS/REL* softkey switches between absolute and relative scaling of the level axis.

GRID ABS is the default setting.

ABS The labelling of the level lines refers to the absolute value of the reference level.

REL The upper line of the grid is always at 0 dB.
The scaling is in dB whereas the reference level is always in the set unit (dBm, dBmV,..).

For setting *RANGE LINEAR* (linear scaling, labelling of axes in %) the softkey is not displayed since the unit % itself implies a relative scale.

Remote command: `DISP:WIND:TRAC:Y:MODE ABS`

RF INPUT 50 Ohm | 75 Ohm

The *RF INPUT 50 Ω / 75 Ω* softkey switches the input impedance of the instrument between 50 Ω (= default setting) and 75 Ω .

The setting 75 Ω should be used if the input impedance (50 Ω) is transformed to 75 Ω using the corresponding adapter unit of type RAZ (= 25 Ω in series to the input impedance of the R&S ESCI). The correction value used for the adoption is 1.76 dB = $10 \log (75\Omega / 50\Omega)$.

All levels specified in this operating manual refer to the default setting of the instrument (50 Ω).

Remote command: `INP:IMP 50OHM`

4.6.4 Setting the Bandwidths and Sweep Time – BW Key

The *BW* key calls a menu for setting the resolution bandwidth (*RBW*), video bandwidth (*VBW*) and sweep time (*SWT*) for the frequency sweep. The parameters may be coupled dependent on the span (stop minus start frequency) or freely set by the user. When working with a split screen display, the settings always refer to the active window.

The R&S ESCI offers resolution bandwidths from 10 Hz to 3 MHz in 1, 3, 10 steps as 3 dB bandwidths; 200 Hz, 9 kHz and 120 kHz as 6 dB bandwidths; and 1 MHz as impulse bandwidth.

Resolution bandwidths up to 120kHz are realized using digital bandpasses with Gaussian characteristics. As far as the attenuation characteristic is concerned they behave like analog filters but have a much higher measurement speed than comparable analog filters. This is due to the fact that the transient response can be compensated as a result of an accurately defined filter behavior.

Bandwidths above 120 kHz are realized using decoupled 4-circuit LC filters.

As an alternative to the analog filters, FFT filters are available for the bandwidths between 1 Hz and 30 kHz. When working with bandwidths up to 30 kHz, the FFT algorithm offers considerably higher measurement speeds with all the other settings remaining the same. The reason is that with analog filters the sweep time required for a particular span is proportional to $(\text{Span}/\text{RBW}^2)$. When using the FFT algorithm, however, the sweep time is proportional to (Span/RBW) .

The video bandwidths are available in 1, 3, 10 steps between 1 Hz and 10 MHz. They can be set in accordance with the resolution bandwidth.

The video filters serve for smoothing the displayed trace. Video bandwidths that are small compared to the resolution bandwidth average out noise peaks and pulsed signals, so that only the signal average is displayed. If pulsed signals are to be measured, it is recommended to use a video bandwidth that is large compared to the resolution bandwidth ($\text{VBW} \geq 10 \times \text{RBW}$) for the amplitudes of pulses to be measured correctly.



For analog and digital filters, the R&S ESCI has overload reserves of different magnitude above the reference level. Due to the LO breakthrough the overload display OVLD responds with digital filters with $\text{RBW} < 100 \text{ kHz}$, as soon as the start frequency is selected $< 6 \times \text{RBW}$; for $\text{RBW} = 100 \text{ kHz}$ as soon as the start frequency is below 3 MHz.

BW

RES BW MANUAL	
VIDEO BW MANUAL	
SWEEPTIME MANUAL	
RES BW AUTO	
VIDEO BW AUTO	
SWEEPTIME AUTO	
COUPLING RATIO ↓	RBW / VBW SINE [1/3]
	RBW / VBW PULSE [0.1]
	RBW / VBW NOISE [10]

	RBW / VBW MANUAL
	SPAN / RBW AUTO [50]
	SPAN / RBW MANUAL
DEFAULT COUPLING	
FILTER TYPE	
Side menu	
VBW MODE LIN LOG	

The *BW* key opens a menu for setting the resolution bandwidth, the video bandwidth, the sweep time and their couplings.

The ...*BW AUTO* softkeys are used to couple the functions. The coupling ratios are selected by means of the *COUPLING RATIO* softkey.

The ...*BW MANUAL* softkeys allow a parameter to be entered. This parameter is not coupled to the other parameters.



With the ...*BW AUTO* softkeys the resolution bandwidth, the video bandwidth and the sweep time can be entered separately for the frequency domain (span > 0 Hz) and the time domain (span = 0 Hz).

But with ...*BW MANUAL* softkeys the selected values apply to both the frequency and time domain.

RES BW MANUAL

The *RES BW MANUAL* softkey activates the manual data entry for the resolution bandwidth.

The resolution bandwidth can be selected in 1/3/10 steps in the range between 10 Hz and 10 MHz. The nominal resolution bandwidth is the 3 dB bandwidth.

200 Hz, 9 kHz and 120 kHz bandwidths are available as 6 dB bandwidths with filter type EMI (6 dB). 1 MHz is available as impulse bandwidth.

When FFT filters are used, the lower limit of the bandwidth is 1 Hz. FFT filters may be used with bandwidths up to 30 kHz.

For numeric inputs, the values are always rounded to the nearest possible bandwidth. For rotary knob or UP/DOWN key inputs, the bandwidth is adjusted in steps either upwards or downwards.

For filter type CHANNEL or RRC, the bandwidth is selected from the list of available channel filters given in section “[Filter Types](#)” on page 4.88.

For data entry, the cursor keys  and  scroll through this list.

The manual input mode of the resolution bandwidth is indicated by a green asterisk (*) on the display.

Remote command: BAND:AUTO OFF;
 BAND 1MHz

VIDEO BW MANUAL

The *VIDEO BW MANUAL* softkey activates the manual data entry for the video bandwidth.

The video bandwidth can be selected in 1/3/10 steps in the range between 1 Hz and 10 MHz.

For numeric inputs, the values are always rounded to the nearest possible allowed bandwidth. For rotary knob or UP/DOWN key inputs, the bandwidth is adjusted in steps either downwards or upwards.

The manual input mode of the video bandwidth is indicated by a green asterisk (*) on the display.

Remote command: `BAND:VID:AUTO OFF;`
 `BAND:VID 10 kHz`

SWEEPTIME MANUAL

The *SWEEPTIME MANUAL* softkey activates the manual data entry for the sweep time. At the same time, the coupling of the sweep time is cancelled. Other couplings (*VIDEO BW*, *RES BW*) remain effective.

In the frequency domain (span > 0 Hz) and for resolution bandwidths above 1 kHz, the allowed sweep times for spans > 3.2 kHz range from 2.5 ms through to 16000 s. With spans below 3.2 kHz, the maximum allowed sweep time is reduced to 5 s * span/Hz.

If FFT filters are used, the sweep time is fixed by the span and the bandwidth and therefore cannot be set.

In time domain (span = 0 Hz), the range of sweep times is 1 μ s to 16000 s is selectable in steps of max. 5% of the sweep time. For numeric inputs, rounding is made to the nearest possible sweep time. For rotary knob or UP/DOWN key inputs, the sweep time is adjusted in steps either downwards or upwards.

The manual input mode of the sweep time is indicated by a green asterisk (*) on the display. If the selected sweep time is too short for the selected bandwidth and span, level measurement errors will occur. This happens because the available settling time for the resolution or video filters is too short. In this case, the R&S ESCI outputs *UNCAL* on the display and marks the indicated sweep time with a red asterisk (*).

Remote command: `SWE:TIME:AUTO OFF;`
 `SWE:TIME 10s`

RES BW AUTO

The *RES BW AUTO* softkey couples the resolution bandwidth to the selected span. Changing the span causes automatic adjustment of the resolution bandwidth.

Automatic coupling of resolution bandwidth to span is always recommended when a favorable setting of the resolution bandwidth in relation to the selected span is desired for the measurement under request.

The coupling ratio is set in the *COUPLING RATIO* submenu.

The *RES BW AUTO* softkey is only available in the frequency domain (span > 0 Hz). The softkey is inactive in the time domain.

Remote command: `BAND:AUTO ON`

VIDEO BW AUTO

The *VIDEO BW AUTO* softkey couples the video bandwidth to the resolution bandwidth. If the resolution bandwidth is changed, the video bandwidth is automatically adjusted.

The coupling of the video bandwidth is always recommended when the minimum sweep time is required for a selected resolution bandwidth. Narrower video bandwidths require longer sweep times due to the longer settling time. Wider bandwidths reduce the signal/noise ratio.

The coupling ratio is set in the *COUPLING RATIO* submenu.

The coupling of the video bandwidth to the resolution filter is also permitted for the time domain display (span = 0).

Remote command: `BAND:VID:AUTO ON`

SWEPTIME AUTO

The *SWEPTIME AUTO* softkey couples the sweep time to the span, video bandwidth (VBW) and resolution bandwidth (RBW). The sweep time is automatically adjusted on any change in span, resolution bandwidth or video bandwidth.

The softkey is only available in the frequency domain (span >0 Hz). It is blanked in the time domain.

The R&S ESCI always selects the shortest sweep time possible without falsifying the signal. The maximum level error compared to using a longer sweep time is < 0.1 dB. If additional bandwidth and level errors are to be avoided, the sweep time is to be set to three times the time offered in coupled mode.

The frequency scan rates required when using the quasipeak detector are defined in Annex B in CISPR 16-2-x:

	Band A	Band B	Band C/D
Frequency range	< 150 kHz	150 kHz to 30 MHz	> 30 MHz
IF bandwidth	200 Hz	9 kHz	120 kHz
Frequency scan rate	20 s/kHz	200 s/MHz	20 s/MHz

The *SWEPTIME AUTO* function is designed for detectors like sample, max peak or average. For sweeping with the quasipeak detector a manual setting of the sweep time should be used at any time.

Remote command: `SWE:TIME:AUTO ON`

COUPLING RATIO

The *COUPLING RATIO* softkey opens a submenu for selection of the coupling ratios.

RBW / VBW SINE [1/3]
RBW / VBW PULSE [0.1]
RBW / VBW NOISE [10]
RBW / VBW MANUAL
SPAN / RBW AUTO [50]
SPAN / RBW MANUAL

When the default setting is active, i.e. the *COUPLING RATIO* softkey is deactivated (not highlighted), the ratio span/resolution bandwidth (SPAN/RBW) is 50 (this corresponds to SPAN / RBW AUTO [50]) and the ratio resolution bandwidth/video bandwidth (RBW/VBW) is 0.33 (this corresponds to RBW / VBW SINE [1/3]).

If the ratio RBW/VBW or SPAN/RBW is different from the default setting, the *COUPLING RATIO* softkey is highlighted.

The softkeys *RBW/VBW...* are selection keys. Only one softkey can be enabled at any one time. The softkeys are only effective for the *VBW AUTO* selection in the main menu.

The softkeys *SPAN/RBW...* are also selection keys. They are only effective for the *RBW AUTO* selection in the main menu.

- RBW / VBW SINE [1/3]** The *RBW | VBW SINE [1/3]* softkey sets the following coupling ratio:
video bandwidth = 3 × resolution bandwidth.
- This is the default setting for the coupling ratio resolution bandwidth/video bandwidth.
- This is the coupling ratio recommended if sinusoidal signals are to be measured.
- Remote command: `BAND:VID:RAT 3`
- This setting is only effective for the *VBW AUTO* selection in the main menu.
- RBW / VBW PULSE [0.1]** The *RBW | VBW PULSE [0.1]* softkey sets the following coupling ratio:
video bandwidth = 10 × resolution bandwidth or
video bandwidth = 10 MHz (= max. VBW).
- This coupling ratio is recommended whenever the amplitudes of pulsed signals are to be measured correctly. The IF filter is exclusively responsible for pulse shaping. No additional evaluation is performed by the video filter.
- Remote command: `BAND:VID:RAT 10`
- This setting is only effective for the *VBW AUTO* selection in the main menu.
- RBW / VBW NOISE [10]** The *RBW/VBW NOISE [10]* softkey sets the following coupling ratio:
video bandwidth = resolution bandwidth/10
- At this coupling ratio, noise and pulsed signals are suppressed in the video domain. For noise signals, the average value is displayed.
- Remote command: `BAND:VID:RAT 0.1`
- This setting is only effective for the *VBW AUTO* selection in the main menu.
- RBW / VBW MANUAL** The *RBW/VBW MANUAL* softkey activates the manual input of the coupling ratio.
The resolution bandwidth/video bandwidth ratio can be set in the range 0.001 to 1000.
- Remote command: `BAND:VID:RAT 10`
- This setting is only effective for the *VBW AUTO* selection in the main menu.
- SPAN / RBW AUTO [50]** The *SPAN/RBW AUTO [50]* softkey sets the following coupling ratio:
resolution bandwidth = span/50
- This coupling ratio is the default setting of the R&S ESCI
- Remote command: `BAND:RAT 0.02`
- This setting is only effective for the *RBW AUTO* selection in the main menu.
- SPAN / RBW MANUAL** The *SPAN/RBW MANUAL* softkey activates the manual input of the coupling ratio.
The span / resolution bandwidth ratio can be set in the range 1 to 10000.
- Remote command: `BAND:RAT 0.1`

This setting is only effective for the *RBW AUTO* selection in the main menu.

DEFAULT COUPLING

The *DEFAULT COUPLING* softkey sets all coupled functions to the default state (*AUTO*). In addition, the ratio *RBW/VBW* is set to *SINE [1/3]* and the ratio *SPAN/RBW* to 50 in the *COUPLING RATIO* submenu (default setting, *COUPLING RATIO* softkey not highlighted).

Remote command: BAND:AUTO ON
 BAND:VID:AUTO ON
 SWE:TIME:AUTO ON

FILTER TYPE

The *FILTER TYPE* softkey opens the selection list for different filter types. In the range up to 30 kHz digital band filters with Gaussian characteristic and filtering with FFT algorithm can be selected.



4.6.4.1 Filter Types

- **NORMAL (3dB):** The resolution bandwidths are implemented by Gaussian filters with the set 3 dB bandwidth and correspond approximately to the noise bandwidth. For bandwidths up to 100 kHz, digital bandpass filters are used.
- **EMI (6dB):** The resolution bandwidths are implemented by Gaussian filters with the set 6 dB bandwidth and correspond approximately to the pulse bandwidth. For bandwidths up to 120 kHz, digital bandpass filters are used.
- **FFT:** An FFT is performed. For that purpose, the filtered IF signal is digitized and then transformed into the spectral domain via FFT. The transformation range depends on the selected filter bandwidths and can be set between 4 kHz to 50 kHz. If the span is larger than the transformation range, several transformations are performed and the results are appended to each other in the spectral domain.

If the span is smaller than the transformation range, the measurement results are interpolated when the number of measurement points provided by the FFT is smaller than the number of display points in x-direction (501). A flattop window serves as a window in the time domain so that high amplitude precision with good selection is achieved.

Compared to bandpasses, FFT filters lead to significantly reduced sweep times. For a span of 50 kHz and a bandwidth of 100 Hz, for instance, the sweep time is reduced from 5 s to 40 ms. FFT filters are particularly suitable for stationary signals (sinusoidal signals or signals that are continuously modulated in time). For burst signals (TDMA) or pulsed signals, normal filters are preferable.

Filter Bandwidth	Filter Type	Application
10 kHz	CFILter	CDMAone ETS300 113 (20 kHz channels) ETS300 113 (25 kHz channels) TETRA PDC IS 136 CDPD, CDMAone
12.5 kHz	CFILter	
14 kHz	CFILter	
16 kHz	CFILter	
18 kHz, $\alpha=0.35$	RRC	
21 kHz	CFILter	
24.3 kHz, $\alpha=0.35$	RRC	
30 kHz	CFILter	
100 kHz	CFILter	FM Radio J.83 (8-VSB DVB, USA)
150 kHz	CFILter	
192 kHz	CFILter	
300 kHz	CFILter	
500 kHz	CFILter	
1.0 MHz	CFILter	CDMAone
1.2288 MHz	CFILter	CDMAone
1.5 MHz	CFILter	DAB

VBW MODE LIN | LOG

The *VBW MODE LIN/LOG* softkey determines the position of the video filter in the signal path for resolution bandwidths ≤ 100 kHz:

- If LINear is selected, the video filter will be in front of the logarithmic amplifier (default).
- If LOGarithmic is selected, the video filter will be behind the logarithmic amplifier.

The essential difference between the two operating modes relates to the settling in case of falling signal edges:

With LINear, the falling signal edge will be "flatter" than with LOGarithmic.

This is due to the conversion from linear power to logarithmic level units: a reduction of the linear power by 50% reduces the logarithmic signal level by only 3 dB.

This is important for EMI measurements above 1 GHz. Below 1 GHz, CISPR 16-1-1 defines the linear average detector only. Above 1 GHz both, the linear and the logarithmic average detector may be specified in product standards. Some standards (e.g. ANSI C63.4:2000) require the linear average detector, whereas microwave oven measurements may be made with the log average detector. CISPR 11 specifies weighted measurements with a VBW of 10 Hz.

Fig. 4.2 shows the response of the linear and the logarithmic average detector for pulse-modulated signals.

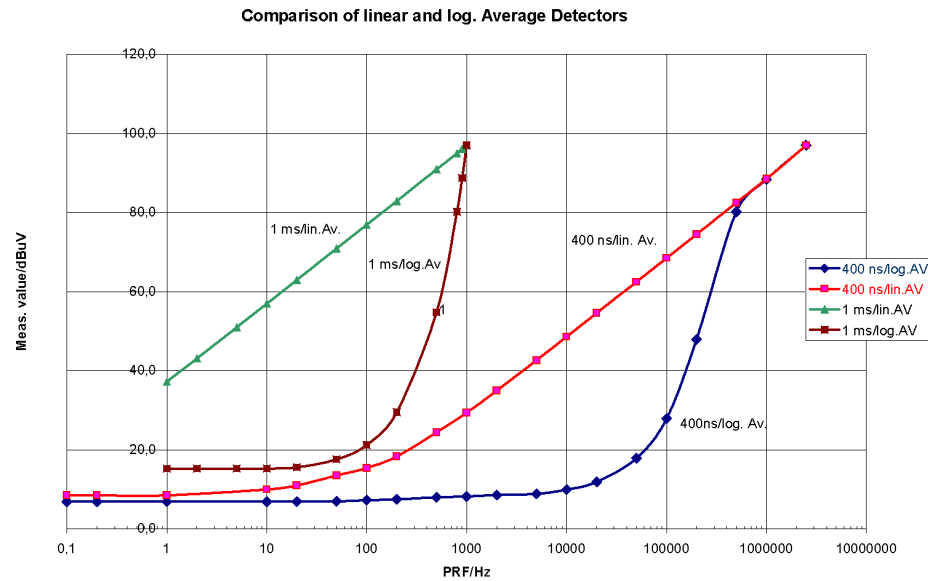

Fig. 4.2 Responses of the linear and the logarithmic average detectors as a function of pulse repetition frequency (PRF) for pulse-modulated signals with pulse durations of 400 ns and 1 ms. Resolution bandwidth is 1 MHz.

Remote command: `BAND:VID:TYPE LIN`

4.6.5 Sweep Settings – SWEEP Key

The SWEEP key serves for configuring the sweep mode and opens the *SWEEP* softkey menu. In split-screen mode, the entries made are valid for the active window only.

The *CONTINUOUS SWEEP*, *SINGLE SWEEP* and *SGL SWEEP DISP OFF* softkeys are mutually exclusive selection keys.

SWEEP

CONTINUOUS SWEEP
SINGLE SWEEP
CONTINUE SGL SWEEP
SWEEPTIME MANUAL
SWEEPTIME AUTO
SWEEP COUNT
SWEEP POINTS
SGL SWEEP DISP OFF

CONTINUOUS SWEEP

The *CONTINUOUS SWEEP* softkey activates the continuous sweep mode, which means that the sweep takes place continuously according to the trigger mode set.

When working in the split-screen mode and with different settings in the two windows, screen A is swept first, followed by screen B. When the softkey is pressed, the sweep is restarted.

CONTINUOUS SWEEP is the default setting of R&S ESCI.

Remote command: `INIT:CONT ON`

SINGLE SWEEP The *SINGLE SWEEP* softkey starts *n* sweeps after triggering. The number of sweeps is determined by the *SWEEP COUNT* softkey.

When working in the split-screen mode, the frequency ranges of the two windows are swept one after the other.

If a trace is swept using *TRACE AVERAGE* or *MAXHOLD*, the value set via the *SWEEP COUNT* softkey determines the number of sweeps. If 0 has been entered, one sweep is performed.

Remote command: `INIT:CONT OFF`

CONTINUE SGL SWEEP The *CONTINUE SGL SWEEP* softkey repeats the number of sweeps set under *SWEEP COUNT*, however without first deleting the trace.

This is particularly of interest when using the functions *TRACE AVERAGE* and *MAXHOLD*, if previously recorded measurement results are to be taken into consideration for averaging / maximum search.

If *SGL SWEEP DISP OFF* is active, the screen is switched off also during repeated sweeps.

Remote command: `INIT:CONM`

SWEEPTIME MANUAL The *SWEEPTIME MANUAL* softkey activates the window for entering the sweep time manually (see also *BW* menu).

Remote command: `SWE:TIME 10s`

SWEEPTIME AUTO The *SWEEPTIME AUTO* softkey activates the automatic selection of the sweep time as a function of the bandwidth of the resolution and video filters (see also *BW* menu).

Remote command: `SWE:TIME:AUTO ON`

SWEEP COUNT The *SWEEP COUNT* softkey activates the window for the entry of the number of sweeps to be performed by R&S ESCI after a single sweep has been started. If Trace Average, Max Hold or Min Hold is activated, this also determines the number of averaging or maximum search procedures.

Example

```
[TRACE1: MAX HOLD]
[SWEEP: SWEEP COUNT: {10} ENTER]
[SINGLE SWEEP]
```

R&S ESCI performs the Max Hold function over 10 sweeps.

The permissible range for the sweep count is 0 to 32767. For sweep count = 0 or 1, one sweep is performed. For trace averaging in the continuous-sweep mode, R&S ESCI performs running averaging over 10 sweeps if sweep count = 0; if sweep count = 1, no averaging, maxhold or minhold is performed.

The sweep count is valid for all the traces in a diagram.



The number of sweeps set in the *TRACE* menu is the same as that in the *SWEEP* menu.

If *SINGLE SWEEP* is selected, the measurement stops after the selected number of sweeps has been performed.

Remote command: `SWE:COUN 64`

SWEEP POINTS

The *SWEEP POINTS* softkey selects the number of measurement samples acquired during a sweep.

The following numbers of points per sweep are available: 125, 201, 251, 401, 501 (default), 801, 1001, 1601, 2001, 4001, 8001



The autopeak detector will be disabled while the number of points per sweep is set to another value than the default.

Remote command: `SWE:POIN 501`

SGL SWEEP DISP OFF

The *SGL SWEEP DISP OFF* softkey deactivates the display while a single sweep is being performed. Once the sweep has been completed, the trace is shown.

Remote command: `INIT:DISP OFF`

4.6.6 Triggering the Sweep – TRIG Key

The *TRIG* key opens a menu for selection of the various trigger sources, trigger polarity and external gate function. The active trigger mode is indicated by highlighting the corresponding softkey.

For video trigger, a trigger threshold can be entered, which is represented in the diagram as a horizontal line.

To indicate that a trigger mode other than *FREE RUN* has been set, the enhancement label **TRG** is displayed on the screen. If two windows are displayed, TRG appears next to the appropriate window.

The TV and RF Trigger (R&S FSP-B6) option adds a number of trigger functions for the analysis of TV signals to this menu, located in the side menu. For details see section [“TV and RF Trigger – Option R&S FSP-B6” on page 4.280](#).

TRIG

FREE RUN	
VIDEO	
EXTERN	
IF POWER	
RF POWER	
TRIGGER OFFSET	
POLARITY POS NEG	
GATED TRIGGER	

GATE SETTINGS ↓	GATE MODE LEVEL EDGE
	POLARITY POS NEG
	GATE DELAY
	GATE LENGTH
	SWEEPTIME
Side menu	
TV TRIGGER SETTINGS	TV TRIGGER ON OFF
	VERT SYNC
	VERT SYNC ODD FIELD / VERT SYNC EVEN FIELD
	HOR SYNC
	VIDEO POL POS NEG
	LINES 625 525
	CCVS INT EXT
DELAY COMP ON OFF	

FREE RUN

The *FREE RUN* softkey activates the free-run sweep mode, i.e. start of a sweep is not triggered. Once a measurement is completed, another is started immediately.

FREE RUN is the default setting of R&S ESCI.

Remote command: TRIG:SOUR IMM

VIDEO

The *VIDEO* softkey activates triggering through the displayed voltage.

For the video triggering mode, a horizontal trigger line is shown in the diagram. It may be used to set the trigger threshold between 0% and 100% of the overall diagram height.

Remote command: TRIG:SOUR VID
 TRIG:LEV:VID 50 PCT

EXTERN

The *EXTERN* softkey activates triggering via a TTL signal at the input connector *EXT TRIGGER/GATE* on the rear panel.

The external trigger level can be adjusted in the range from 0.5 V to 3.5 V. The default value is 1.4 V.

Remote command: TRIG:SOUR EXT <numeric_value>
 SWE:EGAT:SOUR EXT
 TRIG:SEQ:LEV:EXT

IF POWER

The *IF POWER* softkey activates triggering of the measurement via signals which are outside the measurement channel.

For this purpose, the R&S ESCI uses a level detector at the second intermediate frequency. The detector threshold can be selected in a range between -30 dBm and -10 dBm at the input mixer. The resulting trigger level at the RF input is calculated via the following formula:

$$\text{MixerLevel}_{\min} + \text{RFAtt} - \text{PreampGain} \leq \text{InputSignal} \leq \text{MixerLevel}_{\max} + \text{RFAtt} - \text{PreampGain}$$

The bandwidth at the intermediate frequency is 10 MHz. The R&S ESCI is triggered as soon as the trigger threshold is exceeded within a 5 MHz range around the selected frequency (= start frequency in the frequency sweep).

Thus, the measurement of spurious emissions, e.g. for pulsed carriers, is possible even when the carrier lies outside the selected frequency span.

Remote command: `TRIG:SOUR IFP`
 `SWE:EGAT:SOUR IFP`

RF POWER

For details see section [“TV and RF Trigger – Option R&S FSP-B6” on page 4.280](#).

**TRIGGER
OFFSET**

The *TRIGGER OFFSET* softkey activates the window for entering the time offset between the trigger signal and the start of the sweep.

Triggering is delayed by the entered time with respect to the trigger signal (time entered > 0) or is started earlier (time entered < 0). The time may be entered in multiples of 125 ns in the range -100 s to 100 s (default 0 s).



A negative offset (pretrigger) can be set in the time domain only (SPAN = 0 Hz) provided GATED TRIGGER is not active in that domain.

The maximum allowed range and the maximum resolution of the pretrigger is limited by the set sweep time:

max. range = - 499/500 × sweep time
 max. resolution = sweep time/500.

Pretriggering is not possible when the rms or the average detector is activated

As a common input signal is used for both trigger and gate when selecting *EXTERN* and *IF POWER*, changes to the gate delay will affect the trigger delay (*TRIGGER OFFSET*) as well.

Remote command: `TRIG:HOLD 10US`

**POLARITY
POS | NEG**

The *POLARITY POS/NEG* softkey selects the polarity of the trigger source.

The sweep starts after a positive or negative edge of the trigger signal. The selected setting is highlighted.

The selection is valid for all trigger modes with the exception of *FREE RUN*; in the gate mode, it also applies to the gate polarity.

The default setting is *POLARITY POS*.

Remote command: `TRIG:SLOP POS`

By using a gate in sweep mode and stopping the measurement while the gate signal is inactive, the spectrum for pulsed RF carriers can be displayed without the superposition of frequency components generated during switching. Similarly, the spectrum can also be examined for an inactive carrier. The sweep can be controlled by an external gate or by the internal power trigger.

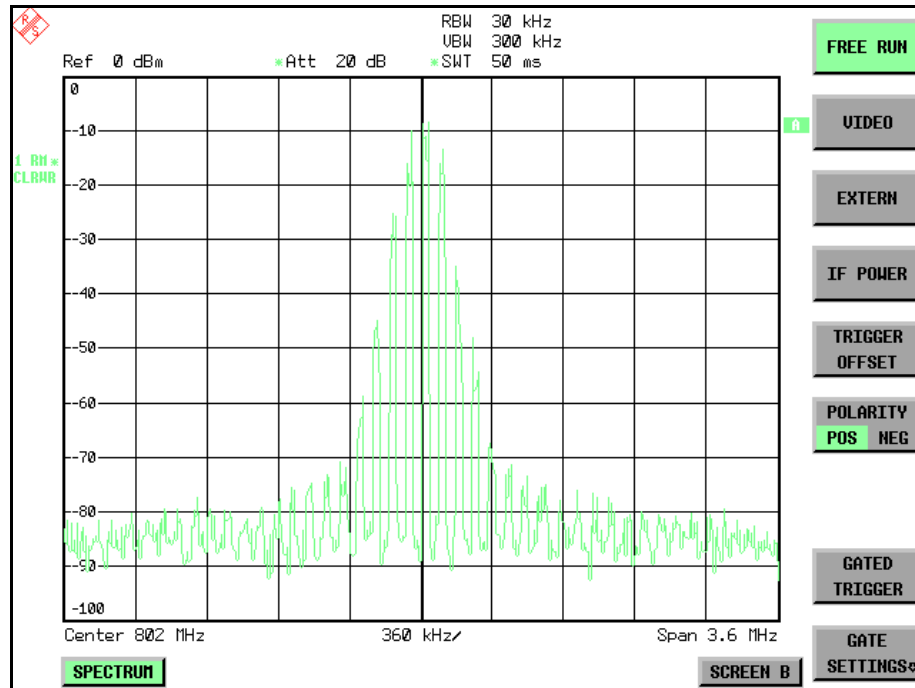

Fig. 4.3 Pulsed signal GATE OFF

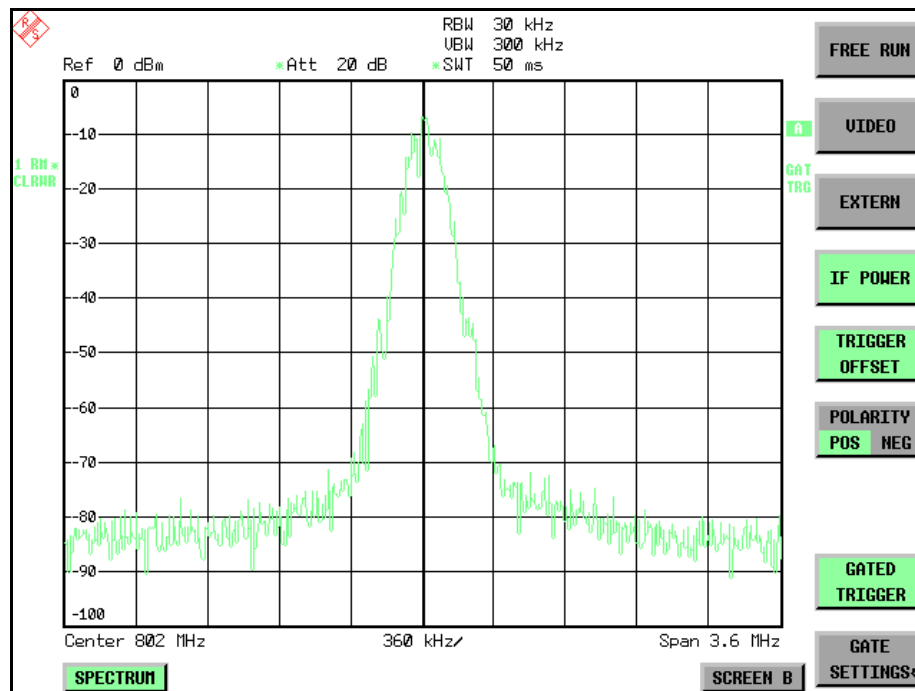

Fig. 4.4 TDMA signal with GATE ON

The gated-sweep mode is activated by the *GATED TRIGGER* softkey. The setting of the mode takes place in the *GATE SETTINGS* submenu.

GATED TRIGGER

The *GATED TRIGGER* softkey switches the sweep mode with gate on and off.

When gate is switched on, a gate signal applied to the rear panel connector *EXT TRIGGER/GATE* or the internal IF power detector controls the sweep of the R&S ESCI. This selection is made via the *EXTERN* and *IF POWER* softkeys for trigger and gate.

The length of the gate signal defines when the sweep is to be interrupted. Here a differentiation is made between edge-triggered and level-triggered modes: in case of edge triggering the gate length can be set via the *GATE LENGTH* softkey, while in case of level triggering the gate length depends on the length of the gate signal.

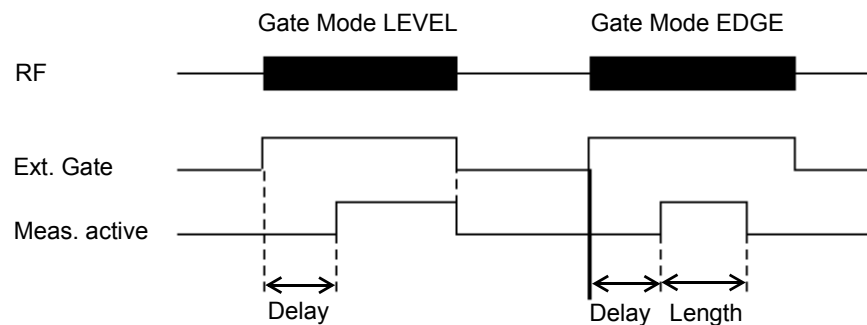

Fig. 4.5 Timing diagram for *GATE*, *GATE DELAY* and *GATE LENGTH*

This softkey requires the *EXTERN* or *IF POWER* trigger mode. If a different mode is active, *IF POWER* is automatically selected.

Gated-sweep operation is also possible in the time domain. This enables - e.g. in burst signals - level variations of individual slots to be displayed versus time.

To indicate that a gate is used for the sweep, the enhancement label **GAT** is displayed on the screen. This label appears to the right of the window for which the gate is configured.

Remote command: SWE:EGAT ON
 SWE:EGAT:SOUR IFP
 or:
 SWE:EGAT:SOUR EXT

GATE SETTINGS

GATE MODE LEVEL EDGE
POLARITY POS NEG
GATE DELAY
GATE LENGTH
SWEEPTIME

The *GATE SETTINGS* softkey calls a submenu for making all the settings required for gated-sweep operation.

At the same time, a transition is made to the time domain (span = 0) and the time parameters *GATE DELAY* and *GATE LENGTH* are represented as vertical lines. This allows the required gate time parameters to be set easily.

For highly accurate setting of gate delay and gate length, the x-axis can be altered using the *SWEEPTIME* softkey in a way that the signal range concerned (e.g. one full burst) is displayed.

Then the sampling time and duration can be set by *GATE DELAY* and *GATE LENGTH* in a way that the desired portion of the signal is shown.

When quitting the submenu, the program will return to the frequency domain provided it was active before. The original span is restored so the desired measurement can now be performed with the accurately set gate.

Remote command: --

GATE MODE The *GATE MODE LEVEL/EDGE* softkey selects the trigger mode. Gated sweep is possible in the level-triggered as well as in the edge-triggered mode.
LEVEL | EDGE

If level triggering is selected, the *GATE LENGTH* softkey becomes inactive and cannot be operated.

Remote command: SWE:EGAT:TYPE EDGE

POLARITY The *POLARITY POS/NEG* softkey controls the polarity of the *EXT TRIGGER/GATE* control line.
POS | NEG

In case of level triggering the sweep is stopped by *POLARITY POS* and a logic '0' signal; the signal '1' will restart the sweep after the *GATE DELAY* time has elapsed.

In case of edge triggering the sweep is continued on a '0' to '1' transition for the duration of *GATE LENGTH* after a delay (*GATE DELAY*) has elapsed.

Changing the polarity automatically implies a transition of the trigger-edge polarity (*POLARITY* softkey in the higher menu).

Remote command: SWE:EGAT:POL POS

GATE DELAY The *GATE DELAY* softkey activates the window for setting the delay time between the gate signal and the continuation of the sweep.

This may be useful for taking into account a delay between the gate signal and the stabilization of an RF carrier for example.

As gate delay, values between 125 ns and 100 s may be set. The position of the delay on the time axis in relation to the sweep is indicated by the line labelled **GD**.

As there is a common input signal for trigger and gate if *EXTERN* or *IF POWER* is selected, changes to the gate delay will affect the trigger delay (*TRIGGER OFFSET*) as well.

Remote command: SWE:EGAT:HOLD 1US

GATE LENGTH The *GATE LENGTH* softkey activates the window for setting the sweep duration of R&S ESCI in the edge-triggered mode.

Values between 125 ns and 100 s may be set for the gate length. The length of the gate in relation to the sweep is indicated by the line labelled **GL**.

This softkey is only available if *GATE MODE EDGE* (edge triggering) has been selected.

Remote command: SWE:EGAT:LENG 100US

SWEEPTIME The *SWEEPTIME* softkey enables the user to change the time axis to obtain a higher resolution for positioning gate delay and gate length.

When this is to be done, the sweep time temporarily changes; the original value is restored when the menu is quit.

Remote command: --

Measurement example

The modulation spectrum of a GSM 900 signal is to be measured using the gated-sweep function. The signal is generated by a Signal Generator whose RF output is directly connected to the RF input of R&S ESCI.

Settings on the Signal Generator:

FREQ: 802 MHz
 Level: 0 dBm: Return
 Digital Mod: Select: GMSK: Select
 Source: Select: PRBS: Select: Return
 Level Attenuation: Select: 60 dB: Return

The Signal Generator supplies a GMSK-modulated TDMA signal (GSM).

Settings on R&S ESCI:

Conventions:

[KEY] Menu called by this key. All information between the brackets refers to this menu.
 {Number} Numeric value to be entered for the parameter on hand.
SOFTKEY Softkey to be used for making a selection or entering a value.

[PRESET]

[FREQ: *CENTER {802} MHz]*
[SPAN *{3.6} MHz]*
[AMPT: *REF LEVEL {0} dBm: RF ATTEN MANUAL: {10} dB]*
[BW: *RES BW MANUAL: {30} kHz]*
[TRACE: *TRACE 1 DETECTOR: RMS]*
[SWEEP: *SWEEPTIME MANUAL: {50} ms]*
[TRIG: *EXTERN*
 GATED TRIGGER;
 GATE SETTINGS: GATE MODE EDGE; POLARITY POS
 SWEEPTIME MANUAL {1} ms: GATE DELAY {300} μs:
 GATE LENGTH: {250} μs]

The following figure shows the screen display for setting gate parameters. The vertical lines for gate delay (GD) and gate length (GL) can be adjusted to the burst signal by entering numeric values or by means of the rotary knob.

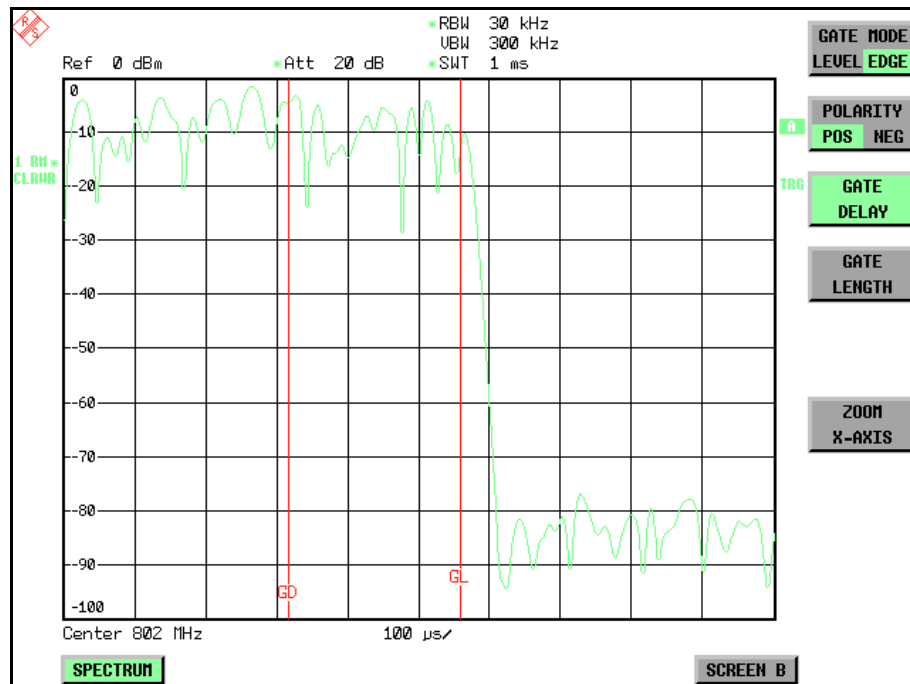

Fig. 4.6 Setting GATE DELAY and GATE LENGTH in time domain by means of lines GD and GL

On quitting the GATE SETTINGS menu, R&S ESCI returns to the previous screen.

TV TRIGGER SETTINGS

The TV and RF Trigger softkey is available with option R&S ESCI-B6 and offers the following submenu. For more information refer to section “TV and RF Trigger – Option R&S FSP-B6” on page 4.280.

TV TRIGGER SETTINGS ↓	TV TRIGGER ON OFF
	VERT SYNC
	VERT SYNC ODD FIELD / VERT SYNC EVEN FIELD
	HOR SYNC
	VIDEO POL POS NEG
	LINES 625 525
	CCVS INT EXT

DELAY COMP ON | OFF

The *DELAY COMP ON/OFF* softkey enables the filter group delay compensation for the external trigger and IF power trigger. If a bursted signal is analyzed in zero span and the delay compensation is on, a change of the RBW will not change the rising slope of the signal.

Default is *OFF*.

Remote command: TRIG:HOLD:ADJ:AUTO ON|OFF

4.6.7 Selection and Setting of Traces – TRACE Key

The R&S ESCI is capable of displaying up to three different traces at a time in a diagram. A trace consists of a maximum of 501 pixels on the horizontal axis (frequency or time). If more measured values than pixels are available, several measured values are combined in one pixel.

The traces are selected using the *SELECT TRACE* softkey in the menu of the *TRACE* key.

The traces can individually be activated for a measurement or frozen after completion of a measurement. Traces that are not activated are blanked.

The display mode can be selected for each trace. Traces can be overwritten in each measurement (*CLEAR/WRITE* mode), averaged over several measurements (*AVERAGE* mode), or a maximum or minimum value can be determined from several measurements and displayed (*MAX HOLD* or *MIN HOLD*).

Individual detectors can be selected for the various traces. The autopeak detector displays maximum and minimum values connected by a vertical line. The max peak detector and min peak detector display the maximum and minimum value of the level within a pixel. The sample detector displays the instantaneous value of the level at a pixel. The rms detector displays the power (rms value) of the measured values within a pixel, the average detector the average value.

4.6.8 Selection of Trace Functions

The trace functions are subdivided as follows:

- Display mode of trace (*CLEAR/WRITE*, *VIEW* and *BLANK*)
- Evaluation of the trace as a whole (*AVERAGE*, *MAX HOLD* and *MIN HOLD*)
- Evaluation of individual pixels of a trace using detectors

The *TRACE* key opens a menu offering the setting options for the selected trace.

In this menu, the mode of representing the measured data in the frequency or time domain in the 501 pixels of the display is determined. Upon start of the measurement, each trace can be displayed either completely new or based on the previous results.

Traces can be displayed, blanked and copied. Traces can also be corrected with the aid of mathematical functions.

The measurement detector for the individual display modes can be selected directly by the user or set automatically by R&S ESCI.

The default setting is trace 1 in the overwrite mode (*CLEAR / WRITE*), the other traces 2 and 3 are switched off (*BLANK*).

The *CLEAR/WRITE*, *MAX HOLD*, *MIN HOLD*, *AVERAGE*, *VIEW* and *BLANK* softkeys are mutually exclusive selection keys.

TRACE

<i>SELECT TRACE</i>	
<i>CLEAR/WRITE</i>	
<i>MAX HOLD</i>	
<i>AVERAGE</i>	

VIEW	
BLANK	
SWEEP COUNT	
DETECTOR ↓	AUTO SELECT
	DETECTOR AUTO PEAK
	DETECTOR MAX PEAK
	DETECTOR MIN PEAK
	DETECTOR SAMPLE
	DETECTOR RMS
	DETECTOR AVERAGE
	DETECTOR QPK
	DETECTOR CISPR RMS
	DETECTOR CISPR AV
TRACE MATH ↓	T1-T2->T1 T1-T3->T1
	TRACE POSITION
	TRACE MATH OFF
Side menu	
MIN HOLD	
HOLD CONT ON OFF	
AVG MODE	
ASCII FILE EXPORT	
DECIM SEP	
COPY TRACE	

SELECT TRACE

The *SELECT TRACE* softkey activates the entry for the active trace (1, 2, 3).

Remote command: -- (selected via numeric suffix of: TRACe)

CLEAR/WRITE

The *CLEAR/WRITE* softkey activates the overwrite mode for the collected measured values, i.e. the trace is overwritten by each sweep.

In the *CLEAR/WRITE* display mode all the available detectors can be selected. In the default mode the autopeak detector (setting *AUTO*) is selected.

Each time the *CLEAR/WRITE* softkey is actuated, R&S ESCI clears the selected trace memory and starts the measurement anew.

Remote command: DISP:WIND:TRAC:MODE WRIT

MAX HOLD

The *MAX HOLD* softkey activates the max peak detector.

The R&S ESCI saves the sweep result in the trace memory only if the new value is greater than the previous one.

The detector is automatically set to *MAX PEAK*. The maximum value of a signal can thus be determined over several sweeps.

This is especially useful with modulated or impulsive signals. The signal spectrum is filled up upon each sweep until all signal components are detected in a kind of envelope.

Pressing the *MAX HOLD* softkey again clears the trace memory and restarts the max hold mode.

Remote command: `DISP:WIND:TRAC:MODE MAXH`

AVERAGE

The *AVERAGE* softkey activates the trace averaging function. The average is formed over several sweeps. Averaging can be performed with any of the detectors available. If the detector is automatically selected by R&S ESCI, the sample detector is used.

Depending on the setting of *AVG MODE*, the logarithmic level values or the measured power/voltage values are averaged.

Averaging is restarted every time the *AVERAGE* softkey is pressed. The trace memory is always cleared.

Remote command: `DISP:WIND:TRAC:MODE AVER`

Description of averaging

Averaging is carried out over the pixels derived from the measurement samples. Several measured values may be combined in a pixel. This means that with linear level display the average is formed over linear amplitude values and with logarithmic level display over levels. For this reason the trace must be measured again when changing between *LIN* and *LOG* display mode. The settings *CONT/SINGLE SWEEP* and running averaging apply to the average display analogously.

There are two methods for calculating the average. For a sweep count = 0, a running average is calculated according to the following formula:

$$\text{TRACE} = \frac{9 \cdot \text{TRACE} + \text{MeasValue}}{10}$$

Due to the weighting between the new measured value and the trace average, past values have practically no influence on the displayed trace after about ten sweeps. With this setting, signal noise is effectively reduced without need for restarting the averaging process after a change of the signal.

If the sweep count is >1, averaging takes place over the selected number of sweeps. In this case the displayed trace is determined during averaging according to the following formula:

$$\text{Trace}_n = \frac{1}{n} \cdot \left[\sum_{i=1}^{n-1} (T_i) + \text{MeasValue}_n \right]$$

where *n* is the number of the current sweep (*n* = 2 ... *SWEEP COUNT*). No averaging is carried out for the first sweep but the measured value is stored in the trace memory. With increasing *n*, the displayed trace is increasingly smoothed since there are more single sweeps for averaging.

After the selected number of sweeps the average trace is saved in the trace memory. Until this number of sweeps is reached, a preliminary average is displayed.

After completion of averaging, i.e. when the averaging length defined by *SWEEP COUNT* is attained, a running averaging is continued with *CONTINUOUS SWEEP* according to the following formula:

$$\text{Trace} = \frac{(N - 1) \cdot \text{Trace}_{\text{old}} + \text{MeasValue}}{N}$$

where

Trace = new trace

Trace_{old} = old trace

N = SWEEP COUNT

The display "Sweep N of N" does not change any more until a new start is triggered.

In the *SINGLE SWEEP* mode, the number of sweeps is triggered with *SWEEP START*. The sweeps are stopped when the selected number of sweeps is attained. The number of the current sweep and the total number of sweeps are shown on the display: "Sweep 3 of 200".

VIEW

The *VIEW* softkey freezes the current contents of the trace memory and displays it.

If a trace is frozen by *VIEW*, the instrument settings can be changed without the displayed trace being modified (exception: level display range and reference level, see below). The fact that the trace and the current instrument setting do not agree any more is indicated by an enhancement label "*" at the right edge of the grid.

If in the *VIEW* display mode the level display range (*RANGE*) or the reference level (*REF LEVEL*) are changed, R&S ESCI automatically adapts the measured data to the changed display range. This allows an amplitude zoom to be made after the measurement in order to show details of the trace.

Remote command: `DISP:WIND:TRAC:MODE VIEW`

BLANK

The *BLANK* softkey activates the blanking of the trace on the screen.

Remote command: `DISP:WIND:TRAC OFF`

SWEEP COUNT

The *SWEEP COUNT* softkey activates the entry of the number of sweeps used for averaging. The allowed range of values is 0 to 30000 and the following should be observed:

- Sweep Count = 0 means running averaging
- Sweep Count = 1 means no averaging, maxhold or minhold is carried out
- Sweep Count > 1 means averaging over the selected number of sweeps; in the continuous sweep mode averaging is performed until the set number of sweeps is attained and is then continued as running averaging.

The default setting is running averaging (Sweep Count = 0). The number of sweeps used for averaging is the same for all active traces in the selected diagram.



The setting of the sweep count in the *TRACE* menu is equivalent to the setting in the *SWEEP* menu.

Remote command: `SWE:COUN 64`

- DETECTOR** See following section [“Selection of Detector” on page 4.108.](#)
- TRACE MATH** See following section [“Mathematical Functions for Traces” on page 4.113.](#)
- MIN HOLD** The *MIN HOLD* softkey activates the min peak detector. R&S ESCI saves for each sweep the smallest of the previously stored/currently measured values in the trace memory. The detector is automatically set to *MIN PEAK*. In this way, the minimum value of a signal can be determined over several sweeps.
- This function is useful e.g. for making an unmodulated carrier in a composite signal visible. Noise, interference signals or modulated signals are suppressed by the min hold function whereas a CW signal is recognized by its constant level.
- Pressing the *MIN HOLD* softkey again clears the trace memory and restarts the min hold function.
- Remote command: `DISP:WIND:TRAC:MODE MINH`
- HOLD CONT ON | OFF** The *HOLD CONT ON/OFF* softkey defines whether the traces in min hold and max hold mode are reset after some specific parameter changes.
- OFF: The traces are reset after some definite parameter changes (default)
 - ON: This mechanism is switched off.
- In general, parameter changes require a restart of the measurement before results are evaluated (e.g. with markers). For those changes that are known to require a new measurement (e.g. modification of the span), the trace is automatically reset so that erroneous evaluations of previous results are avoided.
- This mechanism can be switched off for those exceptional cases where the described behavior is unwelcome.
- Remote command: `:DISP:WIND:TRAC:MODE:HCON ON|OFF`
- AVG MODE** The *AVG MODE* softkey selects logarithmic or linear averaging for the logarithmic level display mode.
- At the same time the difference calculation is switched between linear and logarithmic in submenu *TRACE MATH*.
- Remote command: `CALC:MATH:MODE LIN|LOG|POWER`
- With logarithmic averaging, the dB values of the display voltage are averaged or subtracted from each other with trace mathematical functions. With linear averaging the level values in dB are converted into linear voltages or powers prior to averaging. Voltage or power values are averaged or offset against each other and reconverted into level values.
- For stationary signals the two methods yield the same result.
- Logarithmic averaging is recommended if sinewave signals are to be clearly visible against noise since with this type of averaging noise suppression is improved while the sinewave signals remain unchanged.
- For noise or pseudo-noise signals the positive peak amplitudes are decreased in logarithmic averaging due the characteristic involved and the negative peak values are increased relative to the average value. If the distorted amplitude distribution is averaged, a value is obtained that is smaller than the actual average value. The difference is -2.5 dB.

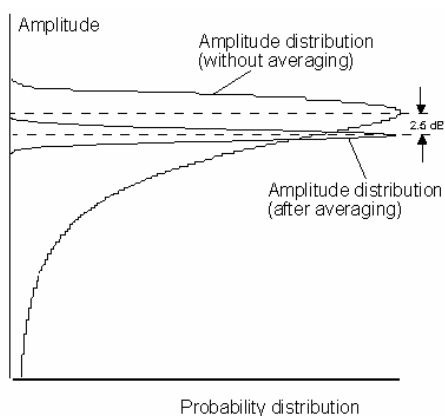

This low average value is usually corrected in noise power measurements by a 2.5 dB factor. Therefore the R&S ESCI offers the selection of linear averaging. The trace data are delogarithmized prior to averaging, then averaged and logarithmized again for display on the screen. The average value is always correctly displayed irrespective of the signal characteristic.

Following selections are available:

LOG	logarithmic averaging
LIN	linear averaging (delogarithmization depends on selected unit). For units VOLT and AMPERE the level values are converted into linear voltages prior to averaging.
POWER	linear averaging (delogarithmization to power for all units)



For correct power averaging with units VOLT or AMPERE, selection *POWER* has to be used.

ASCII FILE EXPORT

The *ASCII FILE EXPORT* softkey stores the active trace in ASCII format, e.g. on a memory stick or a floppy disk.

Remote command: `FORM ASC;`
 `MMEM:STOR:TRAC 1, 'TRACE.DAT'`

The file consists of the header containing important scaling parameters and a data section containing the trace data.

The data of the file header consist of three columns, each separated by a semicolon:

parameter name; numeric value; base unit

The data section starts with the key word " Trace <n> " (<n> = number of stored trace), followed by the measured data in one or several columns (depending on measurement) which are also separated by a semicolon.

This format can be read in from spreadsheet calculation programs, e.g. MS-Excel. It is necessary to define ';' as a separator.



Different language versions of evaluation programs may require a different handling of the decimal point. It is therefore possible to select between separators '.' (decimal point) and ',' (comma) using the *DECIM SEP* softkey.

Example - file header

File contents	Description
Type; R&S ESCI<model>;	Instrument model
Version;1.00;	Firmware version
Date;01.Jul 2009;	Date of data set storage
Mode;Spectrum;	Instrument mode
Center Freq;55000;Hz	Center frequency
Freq Offset;0;Hz	Frequency offset
Span;90000;Hz	Frequency range (0 Hz with zero span and statistics measurements)
x-Axis;LIN;	Scaling of x-axis linear (LIN) or logarithmic (LOG)
Start;10000;Hz Stop;100000;Hz	Start/stop of the display range. Unit: Hz for span > 0, s for span = 0, dBm/dB for statistics measurements
Ref.Level;-30;dBm	Reference level
Level Offset;0;dB	Level offset
Ref Position;75;%	Position of reference level referred to diagram limits (0% = lower edge)
y-Axis;LOG;	Scaling of y-axis linear (LIN) or logarithmic (LOG)
Level Range;100;dB	Display range in y direction. Unit: dB with x-axis LOG, % with x-axis LIN
RF Att;20;dB	Input attenuation
RBW;100000;Hz	Resolution bandwidth
VBW;30000;Hz	Video bandwidth
SWT;0.005;s	Sweep time
Trace Mode;AVERAGE;	Display mode of trace: CLR/WRITE,AVERAGE,MAXHOLD,MINHOLD
Detector;SAMPLE;	Detector set: AUTOPEAK,MAXPEAK,MINPEAK,AVERAGE, RMS,SAMPLE
Sweep Count;20;	Number of sweeps set

Example - data section of the file

File contents	Description
Trace 1;;;	Selected trace
x-Unit;Hz;	Unit of x values: Hz with span > 0; s with span = 0; dBm/dB with statistics measurements
y-Unit;dBm;	Unit of y values: dB*/V/A/Ω depending on the selected unit with y axis LOG or % with y-axis LIN
Values; 501;	Number of measurement points
10000;-10.3;-15.7 10180;-11.5;-16.9 10360;-12.0;-17.4 ...;...;	Measured values: <x value>, <y1>, <y2> <y2> being available only with detector AUTOPEAK and containing in this case the smallest of the two measured values for a test point.

DECIM SEP

The *DECIM SEP* softkey selects the decimal separator between '.' (decimal point) and ',' (comma) with floating-point numerals for the [ASCII FILE EXPORT](#) function.

With the selection of the decimal separator different language versions of evaluation programs (e.g. Microsoft Excel) can be supported.

Remote command: FORM:DEXP:DSEP POIN

COPY TRACE

The *COPY TRACE* softkey copies the screen contents of the current trace into another trace memory. The desired memory is selected by entering the number 1, 2 or 3.

Upon copying, the contents of the selected memory is overwritten and the new contents displayed in view mode.

Remote command: TRAC:COPY TRACE1,TRACE2

4.6.8.1 Selection of Detector

The detectors of the R&S ESCI are implemented as pure digital devices. The following detectors are available:

- [“Peak detectors \(MAX PEAK and MIN PEAK\)” on page 4.109](#)
- [“Auto peak detector” on page 4.109](#)
- [“Sample detector” on page 4.109](#)
- [“RMS detector” on page 4.109](#)
- [“Average detector” on page 4.110](#)
- [“Quasipeak detector” on page 4.110](#)
- [“CISPR RMS detector” on page 4.110](#)
- [“CISPR average detector” on page 4.110](#)

The peak detectors compare the current level value with the maximum or minimum level from the previously sampled data. When the number of samples defined by the instrument setting is reached, the samples are combined in the displayed pixels. Each of the 501 pixels of the display thus represents 1/501 of the sweep range and contains all single measurements (frequency samples) in this subrange in compressed form. For each trace display mode an optimized detector is selected automatically. Since peak detectors and sample detector are connected in parallel, a single sweep is sufficient for collecting all detector values for 3 traces.

Peak detectors (*MAX PEAK* and *MIN PEAK*)

Peak detectors are implemented by digital comparators. They determine the largest of all positive (max peak) or the smallest of all negative (min peak) peak values of the levels measured at the individual frequencies which are displayed in one of the 501 pixels. This procedure is repeated for each pixel so that for wide frequency spans and despite the limited resolution of the display a large number of measurements can be taken into consideration for the display of the spectrum.

Auto peak detector

The *AUTOPEAK* detector combines the two peak detectors. The max peak detector and the min peak detector simultaneously determine the maximum and the minimum level within a displayed test point and display it as a single measured value. The maximum and minimum levels within a frequency point are connected by a vertical line.

Sample detector

The *SAMPLE* detector routes through the sampled data without any further evaluation and either displays them directly or, for reasons of speed in case of short sweep times, first writes them into a memory and processes them subsequently.

There is no data reduction, i.e. no summing up of measured values of neighboring frequencies or time samples. If during a frequency sweep more measured values are obtained than can be displayed, measured values will be lost. This means that discrete signals might be lost.

The sample detector therefore can only be recommended for a span-to-resolution bandwidth ratio of up to approx. 250 in order to ensure that no signal will be suppressed (example: span 1 MHz, -> min. bandwidth 5 kHz).

RMS detector

The RMS detector forms the rms value of the measured values within a pixel.

To this effect, R&S ESCI uses the linear voltage after envelope detection. The sampled linear values are squared, summed and the sum is divided by the number of samples (= root mean square). For logarithmic display the logarithm is formed from the square sum. For linear display the root mean square value is displayed. Each pixel thus corresponds to the power of the measured values summed up in the pixel.

The RMS detector supplies the power of the signal irrespective of the waveform (CW carrier, modulated carrier, white noise or impulsive signal). Correction factors as needed for other detectors for measuring the power of the different signal classes are not required.

Average detector

The average detector forms the average value of the measured values within a pixel.

To this effect, R&S ESCI uses the linear voltage after envelope detection. The sampled linear values are summed up and the sum is divided by the number of samples (= linear average value). For logarithmic display the logarithm is formed from the average value. For linear display the average value is displayed. Each pixel thus corresponds to the average of the measured values summed up in the pixel.

The average detector supplies the average value of the signal irrespective of the waveform (CW carrier, modulated carrier, white noise or impulsive signal).

Quasipeak detector

The quasipeak detector resembles the behavior of an analog voltmeter by evaluating the measured values in a pixel.

The quasipeak detector is especially designed for the requirements of EMC measurements and is used for evaluating pulse-shaped spurious.



During a frequency sweep, R&S ESCI increments the 1st local oscillator in steps that are smaller than approximately 1/10 of the bandwidth. This is to ensure that the signal level is correctly measured. For narrow bandwidths and wide frequency spans a very large number of measured values is thus obtained. The number of frequency steps, however, always is a multiple of 501 (= number of pixels that can be displayed). With the sample detector selected, only every n^{th} value is displayed. The value of n depends on the number of measured values, i.e. on the frequency span, the resolution bandwidth and the measurement rate.

CISPR RMS detector

The CISPR RMS average detector supplies a weighted reading of the input signal. When measuring the RMS-average according to the proposed amendment of CISPR 16-1-1 (CISPR/A/628/CD), the maximum value of the RMS-average during the measurement time is displayed. The detector is used, for example, to measure pulsed sinusoidal signals with a low pulse repetition frequency. It is calibrated with the RMS value of an unmodulated sinusoidal signal. Averaging is with lowpass filters of the 2nd order (simulation of a mechanical instrument). The CISPR RMS detector is available in zero span.

CISPR average detector

The CISPR average detector supplies a weighted average. When measuring the average according to CISPR 16-1-1, the maximum value of the linear average during the measurement time is displayed. The detector is used, for example, to measure pulsed sinusoidal signals with a low pulse repetition frequency. It is calibrated with the rms value of an unmodulated sinusoidal signal. Averaging is with lowpass filters of the 2nd order (simulation of a mechanical instrument). The CISPR Average detector is available in zero span.

DETECTOR

AUTO SELECT
DETECTOR AUTO PEAK
DETECTOR MAX PEAK
DETECTOR MIN PEAK
DETECTOR SAMPLE
DETECTOR RMS
DETECTOR AVERAGE
DETECTOR QPK
DETECTOR CISPR RMS
DETECTOR CISPR AV

The *DETECTOR* softkey opens a submenu for selecting the detector for the selected trace. The softkey is highlighted if the detector is not selected with *AUTO SELECT*.

The detector can be selected independently for each trace. The *AUTO SELECT* mode selects the optimum detector for each display mode of the trace (Clear/Write, Max Hold or Min Hold).

The softkeys for the detectors are mutually exclusive selection keys.

AUTO SELECT

The *AUTO SELECT* softkey (= default setting) selects the optimum detector for the set display mode of the trace (Clear/Write, Max Hold and Min Hold) and the selected filter mode (bandpass/FFT).

Trace display	Detector (bandpass)	Detector (FFT)
Clear/Write	Auto Peak	Max Peak
Average	Sample	Sample
Max Hold	Max Peak	Max Peak
Min Hold	Min Peak	Max Peak

The detector activated for the specific trace is identified in the respective trace display field as follows:

Detector

Auto Peak	AP
Max Peak	PK
Min Peak	MI
Average	AV
RMS	RM
Sample	SA
Quasipeak	QP

Remote command: DET:AUTO ON

**DETECTOR
AUTO PEAK**

The *DETECTOR AUTOPEAK* softkey activates the autopeak detector.

Remote command: DET APE

DETECTOR MAX PEAK	<p>The <i>DETECTOR MAX PEAK</i> softkey activates the max peak detector. It is recommended for measurement of impulsive signals.</p> <p>Remote command: DET POS</p>
DETECTOR MIN PEAK	<p>The <i>DETECTOR MIN PEAK</i> softkey activates the min peak detector. Weak sine-wave signals become clearly visible in noise using this detector. In case of a composite signal made up of sinewave and impulsive signals, the impulsive signals are suppressed.</p> <p>Remote command: DET NEG</p>
DETECTOR SAMPLE	<p>The <i>DETECTOR SAMPLE</i> softkey activates the sample detector.</p> <p>It is used for measuring uncorrelated signals such as noise. The power can be determined with the aid of fixed correction factors for evaluation and the logarithmic function.</p> <p>Remote command: DET SAMP</p>
DETECTOR RMS	<p>The <i>DETECTOR RMS</i> softkey activates the rms detector.</p> <p>The rms detector supplies the power of the signal independent of the waveform. For this effect the root mean square of all sampled level values is formed during the sweep of a pixel. The sweep time thus determines the number of averaged values and with increasing sweep time better averaging is obtained. The rms detector is thus an alternative for averaging over several sweeps (see TRACE AVERAGE).</p> <p>Since the video bandwidth must be at least 10 times the resolution bandwidth (RBW) to ensure that video filtering does not invalidate the rms values of the signal, this ratio is set automatically upon activating the detector.</p> <p>Remote command: DET RMS</p>
DETECTOR AVERAGE	<p>The <i>DETECTOR AVERAGE</i> softkey activates the average detector.</p> <p>In contrast to the rms detector, the average detector supplies the linear average of all sampled level values during the sweep of a pixel.</p> <p>The same relations as for the rms detector apply (see above).</p> <p>Remote command: DET AVER</p>
DETECTOR QPK	<p>The <i>DETECTOR QPK</i> softkey activates the quasipeak detector.</p> <p>This detector evaluates the sampled level values during the sweep of a pixel like an analog voltmeter.</p> <p>On switching the quasipeak detector on the video bandwidth is automatically set to 10*RBW so as to exclude the influence of the video filter on the signal evaluation.</p> <p>Remote command: DET QPE</p>
DETECTOR CISPR RMS	<p>The <i>DETECTOR CISPR RMS</i> softkey activates the CISPR rms detector.</p> <p>Remote command: DET CRMS</p>
DETECTOR CISPR AV	<p>The <i>DETECTOR CISPR AV</i> softkey activates the CISPR average detector.</p> <p>Remote command: DET CAV</p>



The *DETECTOR CISPR RMS* and *DETECTOR CISPR AV* softkeys are only available in zero span mode. The bandwidth is limited to the values 200 Hz, 9 kHz, 120 kHz and 1 MHz. In order to use the normal bandwidths again, the detector must be changed, e.g. using *AUTO SELECT*.

4.6.8.2 Mathematical Functions for Traces

TRACE MATH

The *TRACE MATH* softkey opens a submenu in which the difference between the selected trace to trace 1 is calculated. The softkey is highlighted if a math function is activated.

T1-T2->T1 T1-T3->T1
TRACE POSITION
TRACE MATH OFF

T1-T2->T1 |
T1-T3->T1

The *T1-T2* and *T1-T3* softkeys subtract the corresponding traces. The result displayed is referred to the zero point defined by *TRACE POSITION*.

To indicate that the trace has been obtained by subtraction, the difference "1 - 2" or "1 - 3" is indicated on the trace info of trace 1 and in the *TRACE* main menu the *TRACE MATH* softkey is highlighted.

Remote command: `CALC:MATH (TRACE1-TRACE2)`
 `CALC:MATH (TRACE1-TRACE3)`

TRACE
POSITION

The *TRACE POSITION* softkey activates the entry of the trace position for 0 difference. The position is stated in % of the diagram height.

The range of values extends from -100% to +200%

Remote command: `CALC:MATH:POS 50PCT`

TRACE MATH
OFF

The *TRACE MATH OFF* softkey switches the math function off.

Remote command: `CALC:MATH:STAT OFF`

4.6.9 Recording the Correction Data – CAL Key

The R&S ESCI obtains its high measurement accuracy through its inbuilt self-alignment method.

The correction data and characteristics required for the alignment are determined by comparison of the results at different settings with the known characteristics of the high-precision calibration signal source of R&S ESCI at 128 MHz. The correction data are then available in the instrument as a file and can be displayed by means of the *CAL RESULTS* softkey.

For service purposes the use of correction data can be deactivated by means of the *CAL CORR ON/OFF* softkey. If the correction data recording is aborted, the last complete correction data set is restored.



The term "Calibration" formerly used for the integrated self alignment was often mistaken for the "true" calibration of the instrument at the test set in production and in service. It is therefore no longer used although it appears in the abbreviated form in the name of keys ("CAL...").

The *CAL* key opens a menu with the available functions for recording, displaying and activating the data for self alignment.

CAL

CAL TOTAL
CAL ABORT
CAL CORR ON OFF
CAL RESULTS
PAGE UP PAGE DOWN

CAL TOTAL

The *CAL TOTAL* softkey starts the recording of correction data of the instrument.

If the correction data recording has failed or if the correction values are deactivated (*CAL CORR = OFF* softkey), *UNCAL* is displayed in the status field.

Remote command: *CAL?

CAL ABORT

The *CAL ABORT* softkey interrupts the recording of correction data and restores the last complete correction data set.

Remote command: CAL:ABOR

CAL CORR ON | OFF

The *CAL CORR ON/OFF* softkey switches the calibration data on/off.

- ON: The status message depends upon the results of the total calibration.
- OFF: The message *UNCAL* appears in the status line.

Remote command: CAL:STAT ON

CAL RESULTS

The *CAL RESULTS* softkey calls the *CALIBRATION RESULTS* table, which shows the correction data found during calibration.

The *CALIBRATION RESULTS* table contains the following information:

- date and time of last record of correction values
- overall results of correction value record
- list of found correction values according to function/module

The results have the following meaning:

PASSED	calibration successful without any restrictions
CHECK	deviation of correction value larger than expected, correction could however be performed
FAILED	deviations of correction value too large, no correction was possible. The found correction data are not valid.
ABORTED	calibration aborted

CALIBRATION RESULTS			
Total Calibration Status: PASSED			
Rohde&Schwarz,ESCI-40,123456/999,4.22			
Date (dd/mm/yyyy): 22/02/2008 Time: 11:47:26			
Runtime: 01:27			
Linear detector offset [%]			
			3.75
LC center frequencies			
LC-cycle	DAC [%]	Error[kHz]	
1	44.09	-2.00	PASSED
2	45.65	0.00	PASSED
3	42.53	0.00	PASSED
4	44.88	0.00	PASSED
Bandwidths and center frequency offsets			
RBW	DAC [%]	E [RBW %]	
300 kHz 3 dB CenterFreq	46.97	0.60	PASSED

Remote command: CAL:RES?

PAGE UP | PAGE DOWN

The softkeys *PAGE UP* and *PAGE DOWN* scroll one page forward or backward in the *CALIBRATION RESULTS* table. They have no function when the table is closed.

Remote command: --

4.6.10 Markers and Delta Markers – MKR Key

The markers are used for marking points on traces, reading out measurement results and for quickly selecting a display section. R&S ESCI provides four markers per display window. All markers can be used either as markers or delta markers. The availability of marker functions depends on whether the measurement is performed in the frequency, time or level domain.

The marker that you can move is defined in the following as the **active marker**.

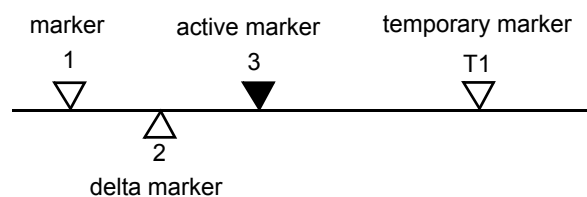

Fig. 4.7 Examples of marker display

Temporary markers are used in addition to the markers and delta markers to evaluate the measurement results. They disappear when the associated function is deactivated.

The measurement results of the active marker (also called **marker values**) are displayed in the marker field. The marker info field at the upper right of the display shows the marker location (here, frequency), the level and the currently selected trace [T1].

MARKER 1 [T1]
-27.5 dBm
123.4567 MHz

The *MKR* key calls a menu that contains all marker and delta marker standard functions. If no marker is active, *MARKER 1* will be enabled and a peak search on the trace carried out. Otherwise, the data entry for the marker activated last is opened.

MKR

MARKER 1 2 3 4 / MARKER NORM DELTA	
SIGNAL COUNT	
REFERENCE FIXED ↓	REF FXD ON OFF
	REF POINT LEVEL
	REF POINT LVL OFFSET
	REF POINT FREQUENCY
	REF POINT TIME
	PEAK SEARCH
MARKER ZOOM	
ALL MARKER OFF	
Side menu	
MKR->TRACE	
LINK MKR1 AND DELTA1	
CNT RESOL ...	
Side menu	
STEPSIZE STANDARD	
STEPSIZE SWP POINTS	
MKR FILE EXPORT	
DECIM SEP	

**MARKER
1|2|3|4 /
MARKER
NORM | DELTA**

The *MARKER 1/2/3/4*.softkey selects the corresponding marker and activates it.

MARKER 1 is always the normal marker. After they have been switched on, *MARKERS 2 to 4* are delta markers that refer to *MARKER 1*. These markers can be converted into markers with absolute value display by means of the *MARKER NORM DELTA* softkey. When *MARKER 1* is the active marker, pressing the *MARKER NORM DELTA* softkey switches on an additional delta marker.

Pressing the *MARKER 1 to 4* softkey again switches off the selected marker.

Example

- [PRESET] R&S ESCI is set to the default setting.
- [MKR] On calling the menu, *MARKER 1* is switched on ('1' highlighted in the softkey) and positioned on the maximum value of the trace. It is a normal marker and the *MARKER NORMAL* softkey is highlighted.
- [MARKER 2] *MARKER 2* is switched on ('2' highlighted in the softkey). It is automatically defined as a delta marker on switching on so the *DELTA* is highlighted on softkey *MARKER NORM DELTA*. The frequency and level of *MARKER 2* with reference to *MARKER 1* are output in the marker info field.
- [MARKER NORM DELTA] The *MARKER NORM DELTA* softkey is highlighted. *MARKER 2* becomes a normal marker. The frequency and level of *MARKER 2* are output as absolute values in the marker info field.
- [MARKER 2] *MARKER 2* is switched off. *MARKER 1* is the active marker for entry. The frequency and level of *MARKER 1* are output in the marker info field.

Remote command:

```

CALC:MARK ON
CALC:MARK:X <value>
CALC:MARK:Y?

CALC:DELT ON
CALC:DELT:MODE ABS|REL
CALC:DELT:X <value>
CALC:DELT:X:REL?
CALC:DELT:Y?

```

When several traces are being displayed, the marker is set to the maximum value (peak) of the active trace which has the lowest number (1 to 3). In case a marker is already located there, it will be set to the frequency of the next lowest level (next peak).

When the split-screen display mode is active, the marker will be placed in the active window. A marker can only be enabled when at least one trace in the corresponding window is visible.

If a trace is turned off, the corresponding markers and marker functions are also deactivated. If the trace is switched on again (*VIEW, CLR/WRITE;..*), the markers along with coupled functions will be restored to their original positions provided the markers have not been used on another trace.

4.6.10.1 Frequency Measurement with the Frequency Counter

In order to accurately determine the frequency of a signal, R&S ESCI is equipped with a frequency counter which measures the frequency of the RF signal at the intermediate frequency. Using the measured IF, R&S ESCI calculates the frequency of the RF input signal by applying the known frequency conversion factors.

The frequency measurement error depends only upon the accuracy of the frequency standard used (external or internal reference). Although R&S ESCI always operates synchronously irrespective of the set span, the frequency counter delivers a more exact result than a measurement performed with a marker. This is due to the following:

- The marker measures only the position of the pixel on the trace and infers the frequency of the signal from this value. The trace, however, contains only a limited number of pixels. Depending upon the selected span, each pixel may contain many measurement values, which therefore limits the frequency resolution.
- The resolution with which the frequency can be measured is proportional to the measurement time. For this reason, the bandwidth is normally made as wide as possible and the sweep time as short as possible. This results in a loss of frequency resolution.

For the measurement with the frequency counter, the sweep is stopped at the reference marker, the frequency is counted with the desired resolution and then the sweep is allowed to continue.

SIGNAL COUNT

The *SIGNAL COUNT* softkey switches the frequency counter on/off.

The frequency is counted at the position of the reference marker (*MARKER 1*). The sweep stops at the reference marker until the frequency counter has delivered a result. The time required for a frequency measurement depends on the selected frequency resolution. The resolution is set in the side menu.

If no marker is enabled when the *SIGNAL COUNT* softkey is pressed, *MARKER 1* is switched on and set at the largest signal.

In addition, the *SIGNAL COUNT* function is displayed in the marker info field on the screen with [Tx CNT].

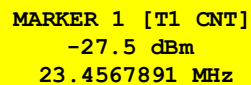

```

MARKER 1 [T1 CNT]
-27.5 dBm
23.4567891 MHz
  
```

Switching the *SIGNAL COUNT* function off is accomplished by pressing the softkey again.

Remote command: `CALC:MARK1:COUN ON;`
 `CALC:MARK:COUN:FREQ?`

The resolution of the frequency counter is set in the *NEXT* menu of the *MARKER* menu. R&S ESCI offers counter resolutions between 0.1 Hz and 10 kHz.

**REFERENCE
FIXED**

REF FXD ON OFF
REF POINT LEVEL
REF POINT LVL OFFSET
REF POINT FREQUENCY
REF POINT TIME
PEAK SEARCH

The *REFERENCE FIXED* softkey defines the level and the frequency or time of *MARKER 1* as a reference for one or several delta markers. The measured values for one or several markers displayed in the marker info field are derived from this reference point instead of the current values of the reference marker (*MARKER 1*).

On actuating the softkey, reference fixed is switched on and thus, the level value and the frequency, time or x-level value of *MARKER 1* immediately become the reference point.

Additionally, the *REFERENCE FIXED* softkey opens the submenu where it is possible to determine manually a reference point with level and frequency, time or x-axis level, to define a level offset or deactivate the reference point.

The *REFERENCE FIXED* function is useful for the measurement of the harmonic suppression at small span (fundamental not represented).

REF FXD ON | OFF The *REF FXD ON/OFF* softkey switches on or off the relative measurement to a fixed reference value (*REFERENCE POINT*) independent of the trace.

Remote command: `CALC:DELT2:FUNC:FIX ON`

REF POINT LEVEL The *REF POINT LEVEL* softkey enters a reference level independent of the reference marker level. All relative level values of the delta markers refer to this reference level.

Remote command: `CALC:DELT2:FUNC:FIX:RPO:Y -10dBm`

REF POINT LVL OFFSET The *REF POINT LVL OFFSET* softkey specifies a level offset relevant to the reference level. The relative level values of the delta markers refer to the reference point level plus the level offset.

The level offset is set to 0 dB on enabling the *REFERENCE FIXED* or *PHASE NOISE* function.

Remote command: `CALC:DELT2:FUNC:FIX:RPO:Y:OFFS 0dB`

REF POINT FREQUENCY With the *REF POINT FREQUENCY* softkey a reference frequency can be manually activated for the delta markers when the *REFERENCE FIXED* or *PHASE NOISE* function is used.

Remote command: `CALC:DELT2:FUNC:FIX:RPO:X 10.7MHz`

REF POINT TIME The *REF POINT TIME* softkey activates the entry box for the input of a reference time for the *REFERENCE FIXED* function in the time domain (span = 0 Hz).

Remote command: `CALC:DELT2:FUNC:FIX:RPO:X 5MS`

For phase noise measurement, input of reference time is not possible.

PEAK SEARCH The *PEAK SEARCH* softkey defines the maximum of the selected trace as reference level for all delta markers when using the *REFERENCE FIXED* function.

Remote command: `CALC:DELT2:FUNC:FIX:RPO:X -5DBM`

Measurement example

Small-span harmonics measurement to increase sensitivity

CW signal (e.g. 100 MHz, 0 dBm) with harmonics at the RF input of R&S ESCI.

- [PRESET] R&S ESCI is set to the default setting.
- [CENTER: 100 MHz] The center frequency of R&S ESCI is set to 100 MHz.
- [SPAN: 1 MHz] The span is set to 1 MHz.
- [AMPL: 3 dBm] The reference level is set to 3 dBm (3 dB above the expected RF level).
- [MKR] *MARKER 1* is switched on ('1' highlighted in the softkey) and set to the signal peak.
- [MARKER 2] *MARKER 2* is switched on and automatically defined as the delta marker (*DELTA* is highlighted on *MARKER NORM DELTA* softkey).
- [REFERENCE FIXED] The frequency and level of *MARKER 1* are a reference for the delta marker.
- [CENTER: 200 MHz] The center frequency is set to 200 MHz (= frequency of the 2nd harmonic). The reference level may have to be reduced to see the 2nd harmonic from the noise. This does not affect the reference level set with *REFERENCE FIXED*.
- [MKR->: PEAK] The delta marker jumps to the 2nd harmonic of the signal. The level spacing of the harmonic to the fundamental is displayed in the marker info field.

MARKER ZOOM

The *MARKER ZOOM* softkey expands the area around *MARKER 1*. With the zoom function, more details of the spectrum can be seen. The desired display range can be defined in an entry window.

The following sweep is stopped at the position of the reference marker. The frequency of the signal is counted and the measured frequency becomes the new center frequency. The zoomed display range is then configured and the new settings are used by R&S ESCI for further measurements.

As long as switching to the new frequency display range has not yet taken place, pressing the softkey will abort the procedure.

If *MARKER 1* is not active when the softkey is pressed, it is automatically activated and set to the highest peak in the window.

If an instrument setting is changed after selection of *MARKER ZOOM*, the function is aborted.

The *MARKER ZOOM* softkey is only available in the frequency domain (span > 0).

Remote command: `CALC:MARK1:FUNC:ZOOM 1kHz`

ALL MARKER OFF

The *ALL MARKER OFF* softkey switches off all markers (reference and delta markers). It also switches off all functions and displays associated with the markers/delta markers.

Remote command: `CALC:MARK:AOFF`

MKR->TRACE

The *MKR->TRACE* softkey places the active marker on a new trace. The trace is selected via a data entry field. Only those traces can be selected which are visible on the screen in the same window.

The function of this softkey is identical to that of the *MKR->TRACE* softkey in the *MKR->* menu (see "*MKR->TRACE*" on page 4.135).

Example

Three traces are presented on the screen. The marker is always on trace 1 when switching on.

[*MKR ->TRACE*] "2"<ENTER> The marker jumps to trace 2 but remains on the previous frequency or time.

[*MKR ->TRACE*] "3"<ENTER> The marker jumps to trace 3. '

Remote command: `CALC:MARK1:TRAC 1`
`CALC:DELT:TRAC 1`

LINK MKR1 AND DELTA1

With the softkey *LINK MKR1 AND DELTA1* the delta marker 1 can be linked to marker 1, so if the x-axis value of the marker 1 is changed the delta marker 1 will follow on the same x-position. The link is off by default.

Example for setup

- PRESET
- TRACE | MAX HOLD
- TRACE | SELECT TRACE | 2 | AVERAGE
- MKR (Switches marker1 on)
- MARKER NORM DELTA | DELTA (Delta Marker 1 ON)
- MKR-> | MKR->TRACE | 2
- LINK MKR1 AND DELTA1

Now select the Marker1 (by switching MARKER1 from DELTA back to NORM) and when changing the x-axis value (by knob wheel or UP/DOWN keys) the delta marker1 will follow automatically.

The delta marker1 x-value can not be changed away from 0 as long as the link functionality is active.

Remote command: `CALC:DELT:LINK ON | OFF`

CNT RESOL ... The *CNT RESOL ...* softkeys select the counter resolution. They are selection switches, i.e. only one of the can be active at any one time.

The marker stop time, i.e. the frequency measurement time, depends on the selected resolution.

Remote command: `CALC:MARK1:COUN:RES <value>`

Measurement example

The frequency of a CW signal is to be determined by means of the frequency counter with a resolution of 10 Hz.

[PRESET] R&S ESCI is set to the default setting.

[MARKER] *MARKER 1* is switched on and set to the maximum value of the displayed spectrum.

[SIGNAL COUNT] The frequency counter is switched on. R&S ESCI counts the frequency of the signal at the marker position with a resolution of 1 kHz. The counted frequency is indicated in the marker info field.

[NEXT] Changes to the submenu for setting the counter resolution.

[CNT RESOL 10 Hz] The frequency counter resolution is increased to 10 Hz.

STEPSIZE STANDARD

The *STEPSIZE STANDARD* softkey controls the knob increment/decrement of the marker position and uses the grid resolution (span/501).

Remote command: `CALC:MARK:X:SSIZ STAN`

STEPSIZE SWP POINTS

The *STEPSIZE SWP POINTS* softkeys controls the knob increment/decrement of the marker position and uses the available sweep points configured in the *SWEEP* menu.

Remote command: `CALC:MARK:X:SSIZ POIN`

MKR FILE EXPORT

The *MKR FILE EXPORT* softkey saves the data of all active markers of the window to a specified file. The format of the decimal point is defined by the *DECIM SEP* softkey.

Remote command: `M MEM:STOR:MARK 'C:\marker.txt'`

DECIM SEP

The *DECIM SEP* softkey selects the decimal separator between '.' (decimal point) and ',' (comma) for the function *MKR FILE EXPORT*.

Remote command: `FORM:DEXP:DSEP POIN`

4.6.11 Marker Functions – MKR FCTN Key

The *MKR FCTN* menu offers further measurements with the markers:

- Measurement of noise density (*NOISE MEAS* softkey)
- Measurement of phase noise (*PHASE NOISE* softkey)
- Measurement of filter or signal bandwidth (*N DB DOWN* softkey)
- Activating of AF demodulation (*MARKER DEMOD* softkey)

On calling the menu, the entry for the last active marker is activated (*SELECT MARKER* softkey); if no marker is activated, marker 1 is activated and a maximum search (*PEAK* softkey) is performed. The marker can be set to the desired trace by means of *MKR->TRACE* softkey.

MKR FCTN

SELECT MARKER	
PEAK	
NOISE MEAS	
PHASE NOISE ↓	PH NOISE ON OFF
	REF POINT LEVEL
	REF POINT LVL OFFSET
	REF POINT FREQUENCY
	PEAK SEARCH
	AUTO PEAK SEARCH
N DB DOWN	
PEAK LIST ↓	NEW SEARCH
	SORT MODE FREQ LEVEL
	PEAK EXCURSION
	LEFT LIMIT RIGHT LIMIT
	THRESHOLD
	PEAK LIST OFF
	PEAK LIST EXPORT
	Decim Sep
MARKER DEMOD ↓	MKR DEMOD ON OFF
	AM FM
	SQUELCH
	MKR STOP TIME
	CONT DEMOD
MKR->TRACE	

4.6.11.1 Activating the Markers

SELECT MARKER

The *SELECT MARKER* softkey activates the numerical selection of the marker in the data entry field. Delta marker 1 is selected by input of ' 0 '.

If the marker is switched off, then it is switched on and can be moved later on.

Remote command: `CALC:MARK1 ON;`
 `CALC:MARK1:X <value>;`
 `CALC:MARK1:Y?`

PEAK

The *PEAK* softkey sets the active marker/delta marker to the peak of the trace.

Remote command: `CALC:MARK1:MAX`
 `CALC:DELT1:MAX`

4.6.11.2 Measurement of Noise Density

NOISE MEAS

The *NOISE MEAS* softkey switches the noise measurement for the active marker on or off. The corresponding marker becomes the *NORMAL* marker.

During noise measurement, the noise power density is measured at the position of the marker. In the time domain mode, all points of the trace are used to determine the noise power density. When measurements are performed in the frequency domain, two points to the right and left of the marker are used for the measurement to obtain a stable result.

The noise power density is indicated in the marker field. With a logarithmic amplitude units (dBm, dBmV, dBm μ V, dB μ A) the noise power density is output in dBm/Hz i.e. as level in 1 Hz bandwidth with reference to 1 mW. With linear amplitude units (V, A, Ω) the noise voltage density is evaluated in μ V/ \sqrt Hz, the noise current density in μ A/ \sqrt Hz or the noise power density in μ W/Hz.

The following settings have to be made to ensure that the power density measurement yields correct values:

Detector: Sample or RMS
 Video bandwidth: $\leq 0.1 \times$ resolution bandwidth with sample detector
 (corresponds to RBW / VBW NOISE)
 $\geq 3 \times$ resolution bandwidth with RMS detector (corresponds to
 RBW / VBW SINE)

In the default setting, the R&S ESCI uses the sample detector for the noise function.

With the sample detector, the trace can additionally be set to AVERAGE to stabilize the measured values. With RMS detector used, trace averaging must not be used since in this case it produces too low noise levels which cannot be corrected. Instead, the sweep time can be increased to obtain stable measurement results.

The R&S ESCI uses the following correction factors to evaluate the noise density from the marker level:

- Since the noise power is indicated with reference to 1 Hz bandwidth, the bandwidth correction value is deducted from the marker level. It is $10 \times \lg(1 \text{ Hz} / BW_{\text{Noise}})$, where BW_{Noise} is the noise or power bandwidth of the set resolution filter (RBW).

- Sample detector

As a result of video filter averaging and trace averaging, 1.05 dB is added to the marker level. This is the difference between the average value and the RMS value of white noise.

With a logarithmic level axis, 1.45 dB is added additionally. Logarithmic averaging is thus fully taken into account which yields a value that is 1.45 dB lower than that of linear averaging.

- RMS detector

With the exception of bandwidth correction, no further corrections are required for the RMS detector since it already indicates the power with every point of the trace.

To allow a more stable noise display the adjacent (symmetric to the measurement frequency) points of the trace are averaged.

In time domain mode, the measured values are averaged versus time (after a sweep).

Remote command: `CALC:MARK:FUNC:NOIS ON;`
 `CALC:MARK:FUNC:NOIS:RES?`

Example: Measurement of inherent R&S ESCI noise

[PRESET] The R&S ESCI is set to default setting.

[MARKER] Marker 1 is switched on and set to the maximum value of the displayed spectrum. Set marker to desired frequency using the rotary knob.

[NOISE] The R&S ESCI switches the sample detector on and sets the video bandwidth to 300 kHz ($0.1 \times \text{RBW}$). The power density level of inherent noise is displayed in dBm/Hz in the marker info field.



The R&S ESCI noise figure can be calculated from the measured power density level. It is calculated by subtracting the set RF attenuation (RF Att) from the displayed noise level. 174 is to be added to the result to obtain the R&S ESCI noise figure.

4.6.11.3 Phase Noise Measurement

PHASE NOISE

PH NOISE ON OFF
REF POINT LEVEL
REF POINT LVL OFFSET
REF POINT FREQUENCY
PEAK SEARCH
AUTO PEAK SEARCH

The *PHASE NOISE* softkey switches the *PHASE NOISE* function on/off. Additionally, the softkey opens the submenu for manually setting the reference point. The phase noise measurement can be switched off in the submenu.

MARKER 1 (= reference marker) is used as a reference for the phase noise measurement. The frequency and level of the reference marker are used as fixed reference values, i.e. the *REFERENCE FIXED* function is activated. After switching on the phase noise measurement the reference level or the center frequency can thus be set in a way that the carrier is outside the displayed frequency range, or, for example, a notch filter is switched on to suppress the carrier.

A noise power density measurement is carried out with the delta marker or delta markers. This measurement corresponds to the *NOISE* function in the *MARKER* menu (*MKR*). The result of the phase noise measurement is the difference in level between the reference point and the noise power density.

The following possibilities can be selected on switching on *PHASE NOISE*:

No marker enabled:

- [**MKR FCTN**] *MARKER 1* is enabled and set to peak.
- [*PHASE NOISE*] *MARKER 1* becomes the reference marker, *MARKER 2* the delta marker; frequency = frequency of the reference marker. The delta marker is the active marker, i.e. it can be moved with the rotary knob or adjusted by entering numerals.
- The *PHASE NOISE* function is switched on and the measured value is output.

Markers are enabled:

- [**MKR FCTN**] The previous marker configuration remains unchanged.
- [*PHASE NOISE*] *MARKER 1* becomes the reference marker. If other markers are enabled, they become delta markers and measure the phase noise at their respective positions.

If further markers are enabled during the phase noise measurement, they automatically become delta markers and measure the phase noise at their respective positions.

When the phase noise measurement is switched off, the marker configuration remains unchanged and the delta markers measure the relative level to the reference marker (*MARKER 1*).

The *PHASE NOISE* function measures the noise power at the delta markers referred to 1 Hz bandwidth. The sample detector is automatically used and the video bandwidth set to 0.1 times the resolution bandwidth (RBW). The two settings are taken into account in the correction values used for the noise power measurement.

To obtain stable results, two pixels on the right and the left of the respective delta marker position are taken for the measurement. The procedure for determining the noise power is identical to the method used for the noise power measurement (see *NOISE* softkey). The measured noise level referred to 1 Hz bandwidth is subtracted from the carrier level at the reference marker (*MARKER 1*). The measured values are displayed in the delta marker field in dBc/Hz (= spacing in dB of the noise power from the carrier level in 1 Hz bandwidth).

If several delta markers are enabled, only the value read by the active marker is shown in the marker field. If several delta markers are active, their measurement results are shown in the marker info field.

The reference value for the phase noise measurement can be defined with *REF POINT LEVEL*, *REF POINT FREQUENCY* and *REF POINT LVL OFFSET* to differ from that of the reference marker.

Remote command: --

PH NOISE ON | OFF The *PH NOISE ON/OFF* softkey switches on/off the phase noise measurement. Switching on is performed by means of the *PHASE NOISE* softkey and is only necessary when the phase noise measurement has been switched off in the submenu.

Remote command: `CALC:DELT1:FUNC:PNO ON`
 `CALC:DELT1:FUNC:PNO:RES?`

REF POINT LEVEL The *REF POINT LEVEL* softkey activates an entry box for the input of a reference level other than the reference marker level. The function is identical to that of the softkey with the same name in the *MARKER* menu (*MKR*).

Remote command: `CALC:DELT1:FUNC:FIX:RPO:Y -10dB`

REF POINT LVL OFFSET The *REF POINT LVL OFFSET* softkey activates an entry box for the input of an additional level offset for the phase noise calculation.

This level offset is set to 0 dB on when the *REFERENCE FIXED* or *PHASE NOISE* function is enabled.

Remote command: `CALC:DELT:FUNC:FIX:RPO:Y:OFFS 10dB`

REF POINT FREQUENCY The *REF POINT FREQUENCY* softkey activates an entry box for the manual input of a reference frequency for the *REFERENCE FIXED* or *PHASE NOISE* function.

Remote command: `CALC:DELT1:FUNC:FIX:RPO:X 10.7MHz`

PEAK SEARCH The *PEAK SEARCH* sets the reference point level for delta marker 2 in the selected measurement window to the peak of the selected trace.

Remote command: `CALC:DELT:FUNC:FIX:RPO:MAX`

AUTO PEAK SEARCH The *AUTO PEAK SEARCH* softkey activates an automatic peak search for the reference fixed marker 1 at the end of each particular sweep.

This function may be used for tracking of a drifting source during a phase noise measurement. The delta marker 2, which shows the phase noise measurement result, keeps the delta frequency value. Therefore the phase noise measurement leads to reliable results in a certain offset although the source is drifting. Only if the marker 2 is reaching the border of the span, the delta marker value is adjusted to be within the span. In these cases, choose a larger span.

Remote command: `CALC:DELT:FUNC:PNO:AUTO ON | OFF`

The numeric suffix <1 to 4> of :DELTmarker is irrelevant.

Measurement example

The phase noise of a CW signal at 100 MHz with 0 dBm level is to be measured at 800 kHz from the carrier

[PRESET]	The R&S ESCI is set to the default setting.
[CENTER: 100 MHz]	The center frequency is set to 100 MHz.
[SPAN: 2 MHz]	The span is set to 2 MHz.
[AMPT: 0 dBm]	The reference level is set to 0 dBm.
[MKR FCTN]	MARKER 1 is switched on and positioned at the maximum of the displayed trace.
[PHASE NOISE: 800 kHz]	The phase noise measurement is switched on. The delta marker is positioned on the main marker and the measured phase noise value is displayed in the marker info field. The sample detector is used and the video bandwidth is set to $3 \times \text{RBW}$. When the phase noise measurement function is enabled, the entry of the delta marker frequency is activated. It can be entered directly.

4.6.11.4 Measurement of the Filter or Signal Bandwidth

N DB DOWN

The *N DB DOWN* softkey activates the temporary markers T1 and T2 which are n dB below the active reference marker. Marker T1 is placed to the left and marker T2 at the right of the reference marker. The value n can be input in a window.

The default setting is 3 dB.

Span > 0: The frequency spacing of the two temporary markers is indicated in the marker info field.

Span = 0: The pulse width between the two temporary markers is indicated in the marker info field.

If, for example, it is not possible to form the frequency spacing for the n dB value because of the noise display, dashes are indicated instead of a measured value.

If a negative value is entered than the markers are placed n dB above the active reference marker. This is then a n dB up function which can be used for notch filter measurements:

To switch n dB down on or off:

Remote command: `CALC:MARK1:FUNC:NDBD:STAT ON`

To query the result pulse width:

Remote command: `CALC:MARK1:FUNC:NDBD:RES?`

To query the two marker x-values (in seconds) separated by comma:

Remote command: `CALC:MARK1:FUNC:NDBD:TIME? 'Span = 0`

Further remote commands:

Remote command: `CALC:MARK1:FUNC:NDBD 3dB`
`CALC:MARK1:FUNC:NDBD:FREQ? 'Span > 0`

4.6.11.5 Measurement of a Peak List

PEAK LIST

NEW SEARCH
SORT MODE FREQ LEVEL
PEAK EXCURSION
LEFT LIMIT RIGHT LIMIT
THRESHOLD
PEAK LIST OFF
PEAK LIST EXPORT
DECIM SEP

The *PEAK LIST* softkey allows the peak values of the trace to be determined and entered in a list with 50 entries max. The order of the entries is defined by the *SORT MODE*:

- **FREQ:** sorting in ascending order of frequency values (see screenshot); if span = 0, the entries are sorted in ascending order of time values
- **LEVEL:** sorting according to level

PEAK LIST		
#	FREQUENCY	POWER
1	794.871794871 MHz	-55.37 dBm
2	2.397435897 GHz	-74.70 dBm
3	4.012820512 GHz	-38.00 dBm
4	5.615384615 GHz	-26.04 dBm
5	6.435897435 GHz	-38.02 dBm
6	7.217948717 GHz	-55.39 dBm

The search range can be restricted by means of the *LEFT LIMIT*, *RIGHT LIMIT* and *THRESHOLD* softkeys. The definition of the peak values can be modified using the *PEAK EXCURSION* softkey. The *MKR->TRACE* softkey in the main menu is used to select the trace for searching peak values.

Opening the list performs a single search at the end of the sweep. The *NEW SEARCH* softkey triggers a new sweep, determines the peak values of the trace at the end of the sweep and enters them in the list.

Use the *PEAK LIST OFF* key to delete the list from the screen.

```
Remote command:  INIT:CONT OFF;
                  CALC:MARK:TRAC 1;
                  CALC:MARK:FUNC:FPE:SORT X;
                  INIT;*WAI;
                  CALC:MARK:FUNC:FPE 10;
                  CALC:MARK:FUNC:FPE:COUN?;
                  CALC:MARK:FUNC:FPE:Y?;
                  CALC:MARK:FUNC:FPE:X?
```

NEW SEARCH The *NEW SEARCH* softkey starts a new peak search and enters the results in the peak list.

```
Remote command:  INIT;*WAI;
                  CALC:MARK:FUNC:FPE 10;
                  CALC:MARK:FUNC:FPE:COUN?;
                  CALC:MARK:FUNC:FPE:Y?;
                  CALC:MARK:FUNC:FPE:X?
```

SORT MODE FREQ LEVEL	<p>The <i>SORT MODE FREQ/LEVEL</i> softkey defines the position of the peak values in the list:</p> <ul style="list-style-type: none"> • FREQ: sorting in ascending order of frequency values (time values if span = 0) • LEVEL: sorting according to level <p>Remote command: <code>CALC:MARK:FUNC:FPE:SORT X;</code></p>
PEAK EXCURSION	<p>With level measurements, the <i>PEAK EXCURSION</i> softkey allows the minimum amount to be entered by which a signal must decrease or increase in order to be recognized as a maximum by the peak search function.</p> <p>Values between 0 dB and 80 dB may be entered, the resolution being 0.1 dB</p> <p>Remote command: <code>CALC:MARK:PEXC 6dB</code></p>
LEFT LIMIT RIGHT LIMIT	<p>The <i>LEFT LIMIT</i> and <i>RIGHT LIMIT</i> softkeys define the vertical lines F1/F2 in the frequency domain (span > 0) and T1/T2 in the time domain (span = 0) between which the search is carried out.</p> <p>If only one line is active, the F1/T1 line is used as the lower limit; the upper limit is the stop frequency. If F2/T2 is also active, it defines the upper limit.</p> <p>Remote command: <code>CALC:MARK:X:SLIM:LEFT 1MHZ</code> <code>CALC:MARK:X:SLIM:RIGH 10MHZ</code> <code>CALC:MARK:X:SLIM ON</code></p>
THRESHOLD	<p>The <i>THRESHOLD</i> softkey defines a horizontal threshold line which represents the lower limit of the peak search level range.</p> <p>Remote command: <code>CALC:THR -20dBm</code> <code>CALC:THR ON</code></p>
PEAK LIST OFF	<p>The <i>PEAK LIST OFF</i> softkey switches off the table with the search results.</p> <p>Remote command: <code>--</code></p>
PEAK LIST EXPORT	<p>The <i>PEAK LIST EXPORT</i> softkey stores the content of the marker peak list in ASCII format to the specified file. The format of the decimal point is defined by the <i>DECIM SEP</i> softkey.</p> <p>Remote command: <code>MMEM:STOR:PEAK 'C:\filename.txt'</code></p>
DECIM SEP	<p>The <i>DECIM SEP</i> softkey selects the decimal separator between '.' (decimal point) and ',' (comma) for the function <i>PEAK LIST EXPORT</i>.</p> <p>With the selection of the decimal separator different language versions of evaluation programs (e.g. Microsoft Excel) can be supported.</p> <p>Remote command: <code>FORM:DEXP:DSEP POIN</code></p>

4.6.11.6 AF Demodulation

The R&S ESCI provides demodulators for AM and FM signals. With these demodulators, a displayed signal can be identified acoustically through the use of the internal loudspeaker or with headphones. The frequency at which the demodulation is enabled is coupled to the markers. The sweep stops at the frequency determined by the active marker for the selected time and the RF signal is demodulated. During a measurement in the time domain (span = 0 Hz) the demodulation is continuously on.

The threshold line (*MKR->:SEARCH LIMITS:THRESHOLD*) performs a squelch function in the demodulator. If the threshold is set, the R&S ESCI LF demodulation is switched on only when the signal to be demodulated exceeds the set threshold.

MARKER DEMOD

MKR DEMOD ON OFF
AM FM
SQUELCH
MKR STOP TIME
CONT DEMOD

The *MARKER DEMOD* softkey switches on the audio demodulator and calls a sub-menu in which the demodulation mode and the duration of the demodulation can be selected.

Remote command: `CALC:MARK1:FUNC:DEM ON`

MKR DEMOD ON | OFF

The *MKR DEMOD ON/OFF* softkey switches the demodulation on/off.

In the frequency range (span >0), the frequency scan is stopped at the frequency of the active marker with demodulation switched on – provided that the level is above the threshold line - and the signal is demodulated during the given stop time.

In the time domain (span = 0) demodulation is continuous, i.e. not only active at the marker position.

Remote command: `CALC:MARK1:FUNC:DEM ON`

AM | FM

The softkeys *AM* and *FM* are selector switches one of which only may be active at a time. They set the desired demodulation mode FM or AM. Default setting is AM.

Remote command: `CALC:MARK1:FUNC:DEM:SEL AM`
`CALC:MARK1:FUNC:DEM:SEL FM`

SQUELCH

The *SQUELCH* softkey enables the input of a level threshold below which the audible AF is cut off. The squelch function is associated with the internal trigger function (*TRIGGER* menu), which will be switched on automatically with the squelch. Squelch level and trigger level do have the same value.

The default setting for the squelch is off.

Remote command: `CALC:MARK1:FUNC:DEM:SQU ON | OFF`
`CALC:MARK1:FUNC:DEM:SQU:LEV 80 PCT`

MKR STOP TIME The *MKR STOP TIME* softkey defines the stop time for demodulation at the marker(s).

The R&S ESCI interrupts the frequency sweep at the marker position and activates the demodulation for the duration of the stop time (see also *MKR DEMOD ON/OFF*).

In the time domain (span = 0) the demodulation is continuously active irrespective of the stop time set.

Remote command: `CALC:MARK1:FUNC:DEM:HOLD 3s`

CONT DEMOD The *CONT DEMOD* softkey switches on the continuous demodulation in the frequency domain. If the sweep time is long enough, the set frequency range can be monitored acoustically.

Remote command: `CALC:MARK1:FUNC:DEM:CONT ON`

4.6.11.7 Selecting the Trace

MKR->TRACE The *MKR->TRACE* softkey sets the active marker to different traces. Only those traces can be selected which are visible on the screen in the same window.

The function of the softkey is identical to that of the softkey with the same name in the *MKR->* menu.

Example

Three traces are displayed on the screen. The marker is always on Trace 1 on switching on.

[*MKR ->TRACE*] "1" The marker jumps to Trace 2, but remains at the previous frequency or time.

[*MKR ->TRACE*] "3" The marker jumps to Trace 3.

Remote command: `CALC:MARK:TRAC 2`

4.6.12 Change of Settings via Markers – MKR-> Key

The *MKR->* menu offers functions through which instrument parameters can be changed with the aid of the currently active marker. The functions can be used on markers and delta markers.

On opening the menu, the entry for the last active marker is activated; if no marker was enabled, MARKER 1 is activated and a peak search is performed.

MKR->

SELECT MARKER	
PEAK	
CENTER = MKR FREQ	
REF LEVEL = MKR LVL	
NEXT PEAK	
NEXT PEAK RIGHT	
NEXT PEAK LEFT	

SEARCH LIMITS ↓	LEFT LIMIT / RIGHT LIMIT
	THRESHOLD
	SEARCH LIMIT OFF
MKR->TRACE	
Side menu	
MKR->CF STEPSIZE	
MIN	
NEXT MIN	
NEXT MIN RIGHT	
NEXT MIN LEFT	
EXCLUDE LO	
PEAK EXCURSION	
2. side menu	
AUTO MAX PEAK AUTO MIN PEAK	

SELECT MARKER

The *SELECT MARKER* softkey activates the numerical selection of the marker in the data entry field. Delta marker 1 is selected by input of '0'.

Remote command: `CALC:MARK1 ON`
 `CALC:MARK1:X <value>`
 `CALC:MARK1:Y?`

PEAK

The *PEAK* softkey sets the active marker/delta marker to the peak of the trace. If no marker is active when *MKR->* menu is called, MARKER 1 is automatically switched on and the peak search is performed.

Remote command: `CALC:MARK:MAX`
 `CALC:DELT:MAX`

CENTER = MKR FREQ

The *CENTER = MKR FREQ* softkey sets the center frequency to the current marker or delta marker frequency.

A signal can thus be set to the center of the frequency display range, for example, so that it can then be examined in detail with a smaller span.

The softkey is not available in the time domain (zero span).

Remote command: `CALC:MARK:FUNC:CENT`

Example

A spectrum is displayed with a large span after PRESET. A signal off the center is to be examined in detail:

[PRESET] R&S ESCI is set to the default setting.

[MKR->] MARKER 1 is switched on and automatically jumps to the largest signal of the trace.

[*CENTER=MKR FREQ*] The center frequency is set to the marker frequency. The span is adapted in such a way that the minimum frequency (= 0 Hz) or the maximum frequency is not exceeded.

[*SPAN*] The span can, for example, be reduced using the rotary knob.

REF LEVEL = MKR LVL

The *REF LEVEL = MKR LVL* softkey sets the reference level to the current marker level.

Remote command: `CALC:MARK:FUNC:REF`

Example

A spectrum is displayed with a large span after PRESET. A signal off the center is to be examined in detail:

[*PRESET*] R&S ESCI is set to the default setting.

[*MKR->*] MARKER 1 is switched on and automatically jumps to the largest signal of the trace.

[*CENTER=MKR FREQ*] The center frequency is set to the marker frequency. The span is adapted in such a way that the minimum frequency (= 0 Hz) or the maximum frequency is not exceeded.

[*REF LEVEL = MKR LVL*] The reference level is set to the measured marker level.

[*SPAN*] The span can, for example, be reduced using the rotary knob.

NEXT PEAK

The *NEXT PEAK* softkey sets the active marker/delta marker to the next lower maximum of the selected trace.

Remote command: `CALC:MARK:MAX:NEXT`
`CALC:DELT:MAX:NEXT`

NEXT PEAK RIGHT

The *NEXT PEAK RIGHT* softkey sets the active marker/delta marker to the next lower maximum right of the current marker position on the selected trace.

Remote command: `CALC:MARK:MAX:RIGH`
`CALC:DELT:MAX:RIGH`

NEXT PEAK LEFT

The *NEXT PEAK LEFT* softkey sets the active marker/delta marker to the next lower maximum left of the current marker position the selected trace.

Remote command: `CALC:MARK:MAX:LEFT`
`CALC:DELT:MAX:LEFT`

SEARCH LIMITS

LEFT LIMIT / RIGHT LIMIT
THRESHOLD
SEARCH LIMIT OFF

The *SEARCH LIMITS* softkey limits the search range for maximum or minimum search. The softkey switches to a submenu in which the search range limits can be set in the x and y direction.

LEFT LIMIT / RIGHT LIMIT The *LEFT LIMIT* and *RIGHT LIMIT* softkeys define the two vertical lines F1 and F2 in the frequency domain (span > 0) and T1 / T2 in the time domain (span = 0). The search is performed between these lines in the frequency and time domain

If only *LEFT LIMIT* is enabled, line F1/T1 is the lower limit and the upper limit corresponds to the stop frequency. If *RIGHT LIMIT* is also enabled, it determines the upper limit.

Remote command: `CALC:MARK:X:SLIM:LEFT 1MHZ`
 `CALC:MARK:X:SLIM:RIGH 10MHZ`
 `CALC:MARK:X:SLIM ON`

THRESHOLD The *THRESHOLD* softkey defines the threshold line.

The threshold line represents a limit for the level range of the max. search at the lower end and that of the min. search at the upper end.

Remote command: `CALC:THR -20dBm`
 `CALC:THR ON`

SEARCH LIMIT OFF The *SEARCH LIMIT OFF* softkey disables all limits of the search range.

Remote command: `CALC:MARK:X:SLIM OFF`
 `CALC:THR OFF`

MKR->TRACE The function of this softkey is identical to that of the *MKR->TRACE* softkey in the *MKR* menu (see "*MKR->TRACE*" on page 4.121).

MKR->CF STEPSIZE The *MKR->CF STEPSIZE* softkey sets the step size for the center frequency variation to the current marker frequency, and also sets step size adaptation to *MANUAL*. *CF STEPSIZE* remains at this value until the center frequency entry mode in the *STEP* menu is switched from *MANUAL* to *AUTO* again.

The *MKR->CF STEPSIZE* function is, above all, useful in the measurement of harmonics with large dynamic range (narrow bandwidth and narrow span).

The softkey is not available in the time domain (span = 0 Hz).

Remote command: `CALC:MARK:FUNC:CST`

Example

The harmonics levels of a CW carrier are to be measured at 100 MHz.

[PRESET] R&S ESCI is set to the default setting.

[CENTER: 100 MHz] R&S ESCI sets the center frequency to 100 MHz. The span is set to 200 MHz.

[SPAN: 1 MHz] The span is set to 100 MHz.

[MKR->] MARKER 1 is switched on and set to the maximum value of the signal.

[NEXT] R&S ESCI switches to the submenu.

[MKR->CF STEPSIZE]	The step size of the center frequency setting equals the marker frequency (100 MHz).
[CENTER]	The center frequency entry mode is activated.
[Right key]	The center frequency is set to 200 MHz. The first harmonic of the test signal is displayed.
[MKR->: PEAK]	The marker is set to the harmonic and the level of the latter is output in the marker info field.

MIN The *MIN* softkey sets the active marker/delta marker to the minimum of the selected trace.

Remote command: `CALC:MARK:MIN`
 `CALC:DELT:MIN`

NEXT MIN The *NEXT MIN* softkey sets the active marker/delta marker to the next higher minimum of the selected trace.

Remote command: `CALC:MARK:MIN:NEXT`
 `CALC:DELT:MIN:NEXT`

NEXT MIN RIGHT The *NEXT MIN RIGHT* softkey sets the active marker/delta marker to the next higher minimum right of the current marker position on the selected trace.

Remote command: `CALC:MARK:MIN:RIGH`
 `CALC:DELT:MIN:RIGH`

NEXT MIN LEFT The *NEXT MIN LEFT* softkey sets the active marker/delta marker to the next higher minimum left of the current marker position on the selected trace.

Remote command: `CALC:MARK:MIN:LEFT`
 `CALC:DELT:MIN:LEFT`

EXCLUDE LO The *EXCLUDE LO* softkey limits the frequency range for the marker search functions or disables the limit.

activated Because of the feed through of the first local oscillator to the first intermediate frequency at the input mixer, the LO is represented as a signal at 0 Hz. To avoid the marker jumping to the LO at 0 Hz with the peak function when setting the display range, this frequency is excluded. The minimum frequency to which the marker jumps, is $\geq 6 \times$ resolution bandwidth (RBW).

deactivated No restriction to the search range. The frequency 0 Hz is included in the marker search functions.

Remote command: `CALC:MARK:LOEX ON`

PEAK EXCURSION The *PEAK EXCURSION* softkey enables – for level measurements – the entry of a minimum level value by which a signal must rise or fall so that it will be identified as a maximum or a minimum by the *NEXT PEAK* and *NEXT MIN* search functions.

Valid entries are from 0 dB to 80 dB; the resolution is 0.1 dB.

Remote command: `CALC:MARK:PEXC 10dB`

The default setting for the peak excursion is 6 dB. This value is sufficient for the *NEXT PEAK* and *NEXT MIN* functions since, in this mode, the next lower maximum or next higher minimum will always be detected.

If *NEXT PEAK LEFT* or *NEXT PEAK RIGHT* is selected, these functions search for the next relative maximum left or right of the current marker position irrespective of the current signal amplitude. *Relative maximum* is understood to mean a decrease of the signal amplitude by a defined value – i.e. the peak excursion – right and left of the amplitude peak.

The 6 dB level change set as a default value may be attained already by the inherent noise of the instrument. In such a case, the R&S ESCI would identify noise peaks as maxima or minima. The value entered for the *PEAK EXCURSION* should therefore be higher than the difference between the highest and the lowest value measured for the displayed inherent noise.

The following example illustrates the effect of different settings of the *PEAK EXCURSION*.

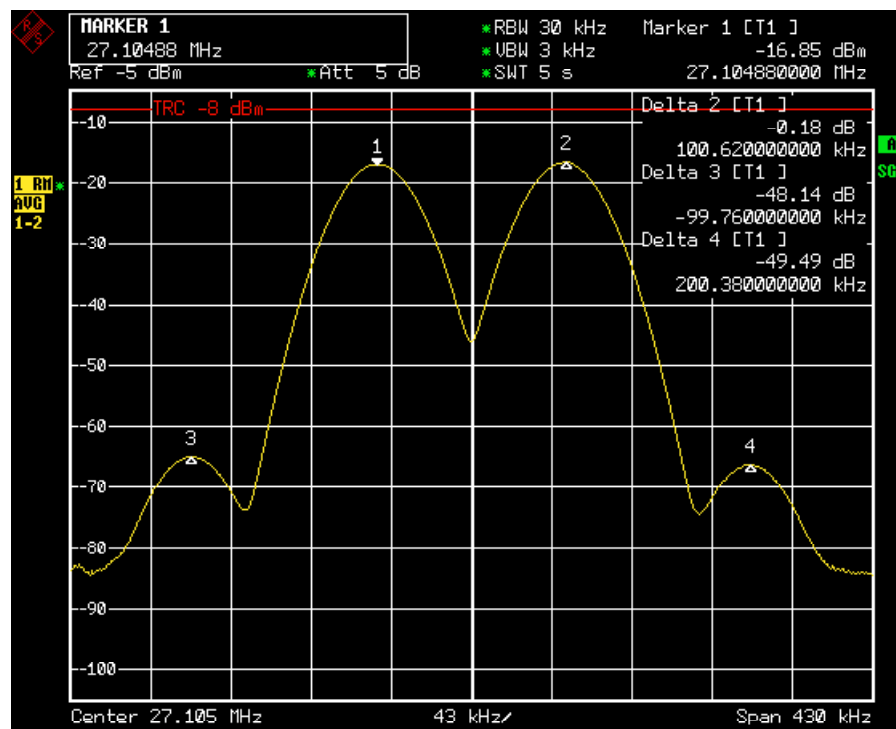

Fig. 4.8 Examples of level measurement with different settings of *PEAK EXCURSION*

The following table lists the signals as indicated by marker numbers in the diagram above, as well as the minimum of the amplitude decrease to both sides of the signal:

signal #	min. amplitude decrease to both sides of the signal
1	30 dB
2	29.85 dB
3	7 dB
4	7 dB

With **40 dB peak excursion**, *NEXT PEAK*, *NEXT PEAK RIGHT* and *NEXT PEAK LEFT* will not find any signal, as the signal level does not decrease by more than 30 dB to either side of any signal.

Order of signals detected:

PEAK: signal 1
 NEXT PEAK: signal 1 (no further signal detected)

or

PEAK: signal 1
 NEXT PEAK LEFT: signal 1 (no further signal detected)
 NEXT PEAK RIGHT: signal 1 (no further signal detected)

With **20 dB peak excursion**, *NEXT PEAK* and *NEXT PEAK RIGHT* will also detect signal 2, as the signal level decreases at least by 29.85 dB to either side of this signal, which is now greater than the peak excursion.

Order of signals detected:

PEAK: Signal 1
 NEXT PEAK: Signal 2
 NEXT PEAK: Signal 2 (no further signal detected)

or

PEAK: Signal 1
 NEXT PEAK LEFT: Signal 1 (no further signal detected)
 NEXT PEAK RIGHT: Signal 2
 NEXT PEAK RIGHT: Signal 2 (no further signal detected)

With **6 dB peak excursion**, all signals will be detected with *NEXT PEAK* and *NEXT PEAK RIGHT / NEXT PEAK LEFT*.

Order of signals detected:

PEAK: Signal 1
 NEXT PEAK: Signal 2
 NEXT PEAK: Signal 3
 NEXT PEAK: Signal 4

or

PEAK: Signal 1
 NEXT PEAK LEFT: Signal 3
 NEXT PEAK RIGHT: Signal 1
 NEXT PEAK RIGHT: Signal 2
 NEXT PEAK RIGHT: Signal 4

AUTO MAX PEAK AUTO MIN PEAK

The *AUTO MAX PEAK / AUTO MIN PEAK* softkeys add an automatic peak search action for marker 1 at the end of each particular sweep. This function may be used during adjustments of a device under test to keep track of the current peak marker position and level.

The current marker search limit settings (LEFT LIMIT, RIGHT LIMIT, THRESHOLD, EXCLUDE LO) are taken into account.

Remote command: CALC:MARK:MAX:AUTO ON | OFF
 CALC:MARK:MIN:AUTO ON | OFF

4.6.13 Power Measurements – MEAS Key

With its power measurement functions the R&S ESCI is able to measure all the necessary parameters with high accuracy in a wide dynamic range.

A modulated carrier is almost always used (except e.g. SSB-AM) for high-frequency transmission of information. Due to the information modulated upon the carrier, the latter covers a spectrum which is defined by the modulation, the transmission data rate and the signal filtering. Within a transmission band each carrier is assigned a channel taking into account these parameters. In order to ensure error-free transmission, each transmitter must be conforming to the specified parameters. These include among others:

- the output power,
- the occupied bandwidth, i.e. the bandwidth which must contain a defined percentage of the power and
- the power dissipation allowed in the adjacent channels.

Additionally the menu contains functions to determine the modulation depth of AM modulated signals and to measure the 3rd order intercept point.

The measurements and the corresponding settings are selected in the *MEAS* menu.

MEAS

TIME DOM POWER ↓
CHAN PWR ACP MULT CARR ACP ↓
OCCUPIED BANDWIDTH ↓
SIGNAL STATISTIC ↓
C/N / C/NO ↓
MODULATION DEPTH
SPECTRUM EMISSION MASK
SPURIOUS EMISSIONS ↓
SELECT MARKER
Side menu
TOI
TOI MKR CALC SRCH
HARMONIC DISTOR ↓

The *MEAS* key opens the menu to select and set the power measurement.

The following measurements can be selected:

- Power in the time domain (“[TIME DOM POWER](#)” on page 4.140)
- Channel power and adjacent-channel power in the frequency domain with a single carrier (“[CHAN PWR ACP MULT CARR ACP](#)” on page 4.148)
- Occupied bandwidth (“[OCCUPIED BANDWIDTH](#)” on page 4.167)
- Carrier-to-noise ratio (“[C/N / C/NO](#)” on page 4.179)
- Amplitude probability distribution (“[SIGNAL STATISTIC](#)” on page 4.171)
- Modulation depth (“[MODULATION DEPTH](#)” on page 4.180)

- Spurious emissions (“SPURIOUS EMISSIONS” on page 4.186)
- 3rd order intercept (“TOI” on page 4.183)
- Harmonic distortion (“HARMONIC DISTOR” on page 4.184)

The above measurements are carried out alternatively.

4.6.13.1 Power Measurement in Time Domain

With the aid of the power measurement function, the R&S ESCI determines the power of the signal in the time domain (SPAN = 0 Hz) by summing up the power at the individual pixels and dividing the result by the number of pixels. In this way it is possible to measure for example the power of TDMA signals during transmission or during the muting phase. Both the mean power and the rms power can be measured by means of the individual power values.

The result is displayed in the marker info field.

The measured values are updated after each sweep or averaged over a user-defined number of sweeps (*AVERAGE ON/OFF* and *NUMBER OF SWEEPS*) in order to determine e.g. the mean power over several bursts. For determination of the peak value (*MAX HOLD ON*) the maximum value from several sweeps is displayed.

Example

Marker info field for: *MEAN* selected, *AVERAGE ON* and *MAX HOLD ON*:

```
MEAN HOLD    -2.33 dBm
MEAN AV      -2.39 dBm
```

If both the on and off phase of a burst signal are displayed, the measurement range can be limited to the transmission or to the muting phase with the aid of vertical lines. The ratio between signal and noise power of a TDMA signal for instance can be measured by using a measurement as a reference value and after that varying the measurement range.

Upon switching on power measurement the sample detector is activated (*TRACE - DETECTOR - SAMPLE*).

TIME DOM POWER

POWER ON OFF
PEAK
RMS
MEAN
STANDARD DEVIATION
LIMIT ON OFF
START LIMIT
STOP LIMIT
Side menu
SET REFERENCE
POWER ABS REL
MAX HOLD ON OFF

AVERAGE ON OFF
NUMBER OF SWEEPS

The *TIME DOM POWER* softkey activates the power measurement in the time domain and opens a submenu for configuration of the power measurement.

The submenu allows selection of the type of power measurement (rms or mean power), the settings for max hold and averaging as well as the definition of limits.

The power evaluation range can be limited by input of limit values.



This softkey is only available in time domain (span = 0).

POWER
ON | OFF

The *POWER ON/OFF* softkey switches the power measurement on and off. When entering the submenu it is *ON* since the power measurement is already switched on with the *TIME DOM POWER* softkey in the main menu.



The measurement is performed on the trace on which marker 1 is placed. To evaluate another trace, marker 1 should be set on another trace using the *SELECT TRACE* softkey in *MARKER* menu (*MKR*).

Remote command:

```
CALC:MARK:FUNC:SUMM:PPE ON
CALC:MARK:FUNC:SUMM:PPE:RES?
CALC:MARK:FUNC:SUMM:RMS ON
CALC:MARK:FUNC:SUMM:RMS:RES?
CALC:MARK:FUNC:SUMM:MEAN ON
CALC:MARK:FUNC:SUMM:MEAN:RES?
CALC:MARK:FUNC:SUMM:SDEV ON
CALC:MARK:FUNC:SUMM:SDEV:RES?
```

PEAK The *PEAK* softkey switches on the calculation of the peak value from the points of the displayed trace or a segment thereof.

For the maximum peak, the largest peak value obtained since the activation of *MAX HOLD ON* is displayed.

With *AVERAGE ON*, the peak values of a trace are averaged over several sweeps and displayed.

The number of sweeps over which the average or the maximum value is calculated is set with the *NUMBER OF SWEEPS* softkey.

Remote command:

```
CALC:MARK:FUNC:SUMM:PPE ON
CALC:MARK:
FUNC:SUMM:PPE:RES?
```

RMS The *RMS* softkey switches on the calculation of the rms value from the points of the displayed trace or a segment of it.

For the maximum peak, the largest rms value obtained since the activation of *MAX HOLD ON* is displayed.

With *AVERAGE ON*, the rms values of a trace are averaged over several sweeps and displayed.

The number of sweeps over which the average or the maximum value is calculated is set with the *NUMBER OF SWEEPS* softkey.

Remote command: `CALC:MARK:FUNC:SUMM:RMS ON`
 `CALC:MARK:FUNC:SUMM:RMS:RES?`

MEAN The *MEAN* softkey switches on the calculation of the mean value from the points of the displayed trace or a segment of it. The linear mean value of the equivalent voltages is calculated.

This can be used for instance to measure the mean power during a GSM burst.

For the maximum peak, the largest mean value obtained since the activation of *MAX HOLD ON* is displayed.

With *AVERAGE ON*, the mean values of a trace are averaged over several sweeps and displayed.

The number of sweeps over which the average or the maximum value is calculated is set with the *NUMBER OF SWEEPS* softkey.

Remote command: `CALC:MARK:FUNC:SUMM:MEAN ON`
 `CALC:MARK:FUNC:SUMM:MEAN:RES?`

STANDARD DEVIATION The *STANDARD DEVIATION* softkey switches on the calculation of the standard deviation of trace points from the mean value and outputs them as measured value. The measurement of the mean power is automatically switched on at the same time.

For the maximum peak, the largest standard deviation obtained since the activation of *MAX HOLD ON* is displayed.

With *AVERAGE ON*, the standard deviations of a trace are averaged over several sweeps and displayed.

The number of sweeps over which the average or the maximum value is calculated is set with the *NUMBER OF SWEEPS* softkey.

Remote command: `CALC:MARK:FUNC:SUMM:SDEV ON`
 `CALC:MARK:FUNC:SUMM:SDEV:RES?`

LIMIT ON | OFF The *LIMIT ON/OFF* softkey selects the limited (*ON*) or non-limited (*OFF*) evaluation range.

The evaluation range is defined by the *START LIMIT* and *STOP LIMIT* softkeys. If *LIMIT = ON*, signals are only searched between the two lines.

If only one limit line is switched on, time line 1 is the lower limit and the upper limit corresponds to the end of sweep. If time line 2 is also switched on, it defines the upper limit.

If no limit line is switched on, the evaluation range is not limited.

The default setting is *LIMIT = OFF*.

Remote command: `CALC:MARK:X:SLIM OFF`

START LIMIT The *START LIMIT* softkey activates the entry of the lower limit of the evaluation range.

Remote command: `CALC:MARK:X:SLIM:LEFT <value>`

STOP LIMIT	<p>The <i>STOP LIMIT</i> softkey activates the entry of the upper limit of the evaluation range.</p> <p>Remote command: <code>CALC:MARK:X:SLIM:RIGH <value></code></p>
SET REFERENCE	<p>The <i>SET REFERENCE</i> softkey sets the power values currently measured as reference values for the calculation of the mean value (<i>MEAN</i>) and the rms value (<i>RMS</i>). The reference values are used to perform relative measurements.</p> <p>If the calculation of the mean value (<i>MEAN</i>) and rms value (<i>RMS</i>) is not switched on, 0 dBm is used as a reference value.</p> <p>If the average value (<i>AVERAGE</i>) or maximum value (<i>MAX HOLD</i>) is calculated over several sweeps, the current value is the measured value summed up at the actual time.</p> <p>Remote command: <code>CALC:MARK:FUNC:SUMM:REF:AUTO ONCE</code></p>
POWER ABS REL	<p>The <i>POWER ABS/REL</i> softkey selects the absolute power measurement (default setting) or relative power measurement. The reference value for the relative power is defined by <i>SET REFERENCE</i>.</p> <p>The value 0 dBm is used if the reference value is not defined.</p> <p>Remote command: <code>CALC:MARK:FUNC:SUMM:MODE ABS</code></p>
MAX HOLD ON OFF	<p>The <i>MAX HOLD ON/OFF</i> softkey switches the display of the maximum peak obtained from measurements at successive sweeps on and off.</p> <p>The displayed maximum peak is only updated at the end of a sweep if a higher value has occurred.</p> <p>The maximum value can be reset by switching the <i>MAX HOLD ON / OFF</i> softkey off and on again.</p> <p>Remote command: <code>CALC:MARK:FUNC:SUMM:PHOL ON</code> <code>CALC:MARK:FUNC:SUMM:PPE:PHOL:RES?</code> <code>CALC:MARK:FUNC:SUMM:RMS:PHOL:RES?</code> <code>CALC:MARK:FUNC:SUMM:MEAN:PHOL:RES?</code> <code>CALC:MARK:FUNC:SUMM:SDEV:PHOL:RES?</code></p>
AVERAGE ON OFF	<p>The <i>AVERAGE ON/OFF</i> softkey switches averaging over successive sweep measurements on and off.</p> <p>The measured values can be reset by switching the <i>AVERAGE ON / OFF</i> softkey off and on again.</p> <p>Remote command: <code>CALC:MARK:FUNC:SUMM:AVER ON</code> <code>CALC:MARK:FUNC:SUMM:PPE:AVER:RES?</code> <code>CALC:MARK:FUNC:SUMM:RMS:AVER:RES?</code> <code>CALC:MARK:FUNC:SUMM:MEAN:AVER:RES?</code> <code>CALC:MARK:FUNC:SUMM:SDEV:AVER:RES?</code></p>

NUMBER OF SWEEPS	The <i>NUMBER OF SWEEPS</i> softkey activates the entry of the number of sweeps for maximum or average value calculation.
<i>SINGLE SWEEP</i> mode	The R&S ESCI performs sweeps until the selected number of sweeps is reached and stops then.
<i>CONTINUOUS SWEEP</i> mode	Averaging is carried out until the selected number of sweeps is reached. After that, averaging is performed in continuous mode and is then continued as running averaging. Calculation of the maximum peak (<i>MAX HOLD</i>) is performed continuously irrespective of the selected number of sweeps.

The valid range values is 0 to 32767.

Depending on the specified number of sweeps, averaging is carried out according to the following rules:

<i>NUMBER OF SWEEPS</i> = 0	Continuous averaging is carried out over 10 measured values.
<i>NUMBER OF SWEEPS</i> = 1	No averaging, maxhold or minhold is carried out.
<i>NUMBER OF SWEEPS</i> > 1	Averaging is carried out over the set number of measured values.



This setting is equivalent to the setting of the sweep count in the *TRACE* menu.

Remote command: `SWE:COUN <value>`

Example

The mean power of a GSM burst with 0 dBm nominal power at 800 MHz is to be measured.

[PRESET]	Set the R&S ESCI to the default setting.
[FREQ: CENTER: 800 MHz]	Set the center frequency to 800 MHz.
[SPAN: ZERO SPAN]	Select time domain display (span = 0 Hz).
[AMPT: 0 dBm]	Set the reference level to 0 dBm.
[BW: RES BW MANUAL: 30 kHz]	Set the resolution bandwidth to 30 kHz in line with the requirements of the GSM standard.
[SWEEP: SWEEPTIME MANUAL 600 µs]	Set the sweep time to 600 µs.
[TRIG: VIDEO: 50%]	Use the video signal as trigger source.
[MEAS]	Call the menu for the measurement functions.

[<i>TIME DOM POWER</i>]	Select power measurement in the time domain. The R&S ESCI calculates the mean power from the points of the whole trace. The submenu for configuration of the power measurement is opened. <i>MEAN</i> is already switched on.
[<i>LIMITS ON</i>]	Activate the limitation of the time domain of the power measurement.
[<i>START LIMIT: 250 μs</i>]	Set the start of the power measurement at 250 μs.
[<i>STOP LIMIT: 500 μs</i>]	Set the end of the power measurement at 500 μs.



The GSM specifications require the power to be measured between 50% and 90% of the TDMA burst. The time limits set above approximately correspond to the required time domain.

4.6.13.2 Channel and Adjacent-Channel Power Measurements

For all channel and adjacent-channel power measurements a specified channel configuration is assumed which is for instance based on a specific radio communication system.

This configuration is defined by the nominal channel frequency (= center frequency of the R&S ESCI if only one carrier is active), the channel bandwidth, the channel spacing, the adjacent-channel bandwidth and the adjacent-channel spacing. The R&S ESCI is able to simultaneously measure the power in up to four transmission channels and up to three adjacent channels (10 channels: 4 transmission channels, 3 lower and 3 upper adjacent channels).

It offers two methods for channel and adjacent-channel power measurement:

- The integrated bandwidth method (IBW method), i.e. the integration of trace pixels within the bandwidth of the channel to be measured to the total power of the channel,
- The measurement in time domain (Fast ACP) by means of steep resolution filters simulating the channel.

The two measurements yield the same results. The measurement in time domain can be performed much faster since the complete signal is measured within a channel at the same time. With the IBW method, the channel is divided into subspectra. This is done by means of a bandwidth which is small compared to the channel bandwidth. These subspectra are then combined by integration of the trace pixels.

With the IBW method, the transmission channels or adjacent channels are marked by vertical lines at a distance of half the channel bandwidth to the left and to the right of the corresponding channel center frequency (see [Fig. 4.9](#)).

With the time-domain method, the power versus time is shown for each channel. The boundaries of the channels are marked by vertical lines (see [Fig. 4.10](#)).

For both methods, the results are listed in tables in the lower half of the screen.

The R&S ESCI offers predefined standard settings which can be selected from a table for the common mobile radio standards. Thus, channel configuration is performed automatically without the need to enter the corresponding parameters manually.

For some standards, the channel power and the adjacent-channel power are to be weighted by means of a root-raised cosine filter corresponding to a receive filter. This type of filtering is switched on automatically for both methods on selecting the standard (e.g. NADC, TETRA or 3GPP W-CDMA).

Addition of firmware starting from version 4.3x:

As of firmware version 4.3x it is possible to configure overlapping adjacent channels. Based on a common carrier channel setting, it is now possible to measure with two slightly different ADJ channel settings with one single measurement at the same time.

Example:

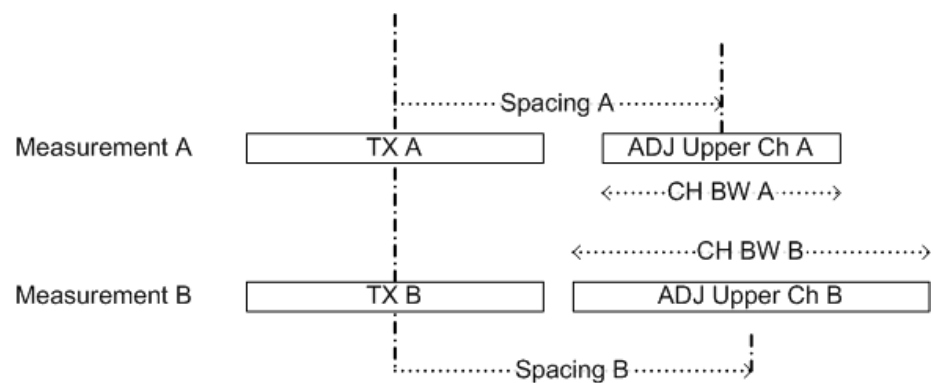

ACP Measurement A and Measurement B are using identical TX channel settings (Channel Bandwidth).

The ADJ settings for Measurement A and measurement B are different.

It is now possible to do both measurements at the same time.

- Configure the ACP measurement with number of ADJ channels = 2.
- Define ADJ settings (bandwidth, spacing) as required for measurement A.
- Define ALT1 settings (bandwidth, spacing) as required for ADJ channel of measurement B
- Perform the ACP measurement
- Read the ACP measurement result

The Carrier Power belongs to measurement A and B

The ADJ result is the ADJ result of measurement A

The ALT1 result is the ADJ result of measurement B.



This feature is only supported for ACP but not for Multi Carrier ACP measurement.

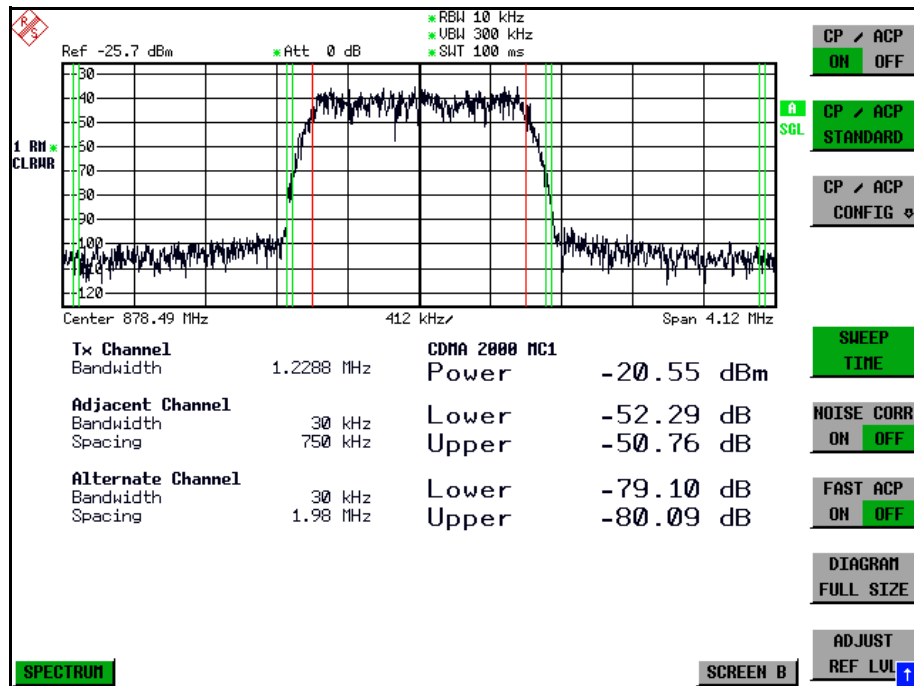

Fig. 4.9 Screen display of adjacent-channel power measurement using the IBW method

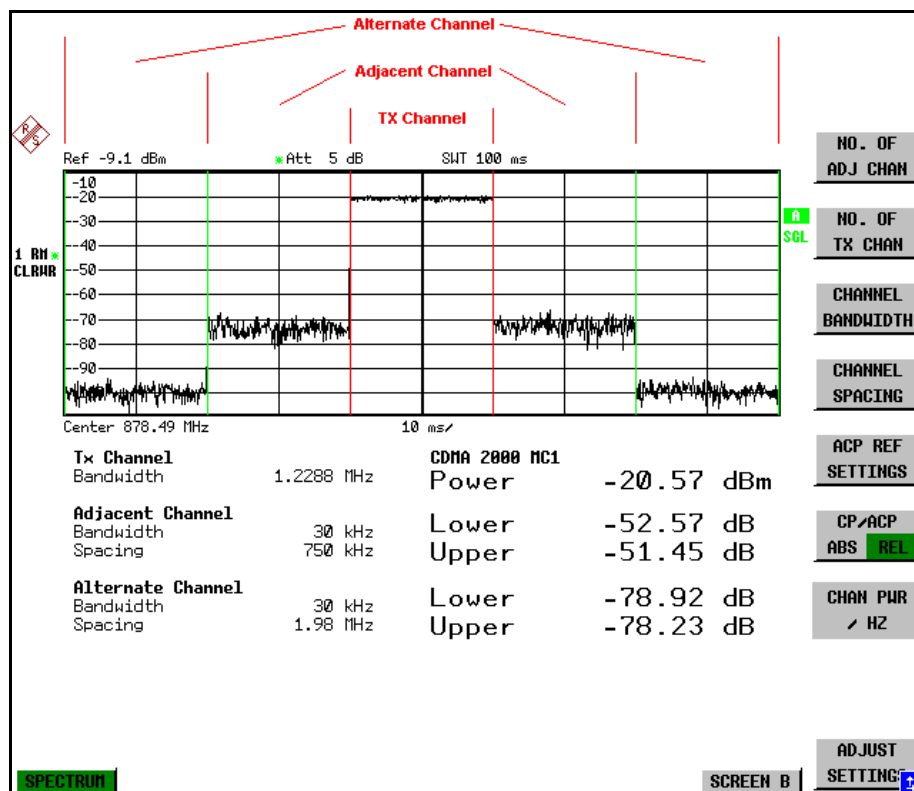

Fig. 4.10 Screen display of adjacent-channel power measurement using the time-domain method

Limit values for the adjacent-channel power can be defined for the measurement. If limit checking is switched on, a pass/fail information indicating that the power has been exceeded is displayed during the measurement in the table in the lower half of the screen.



With the CP/ACP measurement switched on the functions SPLIT SCREEN and FULL SCREEN are inhibited.

The channel configuration is defined in the *MEAS - CHAN PWR ACP* or the *MEAS - MULT CARR ACP* menu.

**CHAN PWR
ACP
MULT CARR
ACP**

CP/ACP ON OFF		
CP/ACP STANDARD		
CP/ACP CONFIG ↓	NO. OF ADJ CHAN	
	NO. OF TX CHAN	
	CHANNEL BANDWIDTH	
	CHANNEL SPACING	
	ACP REF SETTINGS	
	CP/ACP ABS REL	
	CHAN PWR / HZ	
	POWER MODE ↓	CLEAR/WRITE
		MAX HOLD
	ADJUST SETTINGS	
	Side menu	
	ACP LIMIT CHECK	
	EDIT ACP LIMITS	
	WEIGHTING FILTER	WEIGHT TX ON OFF
		WEIGHT TX ALPHA
		WEIGHT ADJ ON OFF
		WEIGHT ADJ ALPHA
	ADJ REFLVL OFFSET	
	SELECT TRACE	
SET CP REFERENCE		
SWEEP TIME		
NOISE CORR ON OFF		
FAST ACP ON OFF		
DIAGRAM FULL SIZE		
ADJUST REF LVL		
SELECT USER STD		
SAVE AS USER STD		
DELETE USER STD		

The *CHAN PWR ACP* and *MULT CARR ACP* softkeys activate channel or adjacent-channel power measurement either for a single carrier signal (*CHAN PWR ACP*) or for several carrier signals (*MULT CARR ACP*), depending on the current measurement configuration. In addition, they open a submenu for defining the parameters for channel power measurement. The softkey selected is shown in color to indicate that a channel or adjacent-channel power measurement is active.



The softkeys are available only for measurements in the frequency domain (span > 0).

**CP/ACP
ON | OFF**

The *CP/ACP ON/OFF* softkey switches calculation of the channel power or adjacent-channel power on and off.

With default settings the measurement is performed by integrating the powers at the display points within the specified channels (IBW method).

The powers of the adjacent channels are measured either as absolute values or as relative values referenced to the power of a transmission channel. The default setting is relative-value measurement (see *CP/ACP ABS/REL* softkey).

When multi carrier ACP measurement is activated, the number of test points is increased to ensure that adjacent-channel powers are measured with adequate accuracy.

Remote command: `CALC:MARK:FUNC:POW:SEL CPOW|ACP|MCAC`
 `CALC:MARK:FUNC:POW:RES?`
 `CPOW|ACP|MCAC`
 `CALC:MARK:FUNC:POW OFF`

**CP/ACP
STANDARD**

The *CP/ACP STANDARD* softkey opens a table for the selection of the settings according to predefined standards. The test parameters for the channel and adjacent-channel measurements are set according to the mobile radio standard.

NONE
 E-UTRA/LTE Square
 E-UTRA/LTE Square/RRC
 W-CDMA 4.096 FWD
 W-CDMA 4.096 REV
 W-CDMA 3GPP FWD
 W-CDMA 3GPP REV
 CDMA IS95A FWD
 CDMA IS95A REV
 CDMA IS95C Class 0 FWD
 CDMA IS95C Class 0 REV
 CDMA J-STD008 FWD
 CDMA J-STD008 REV
 CDMA IS95C Class 1 FWD
 CDMA IS95C Class 1 REV
 CDMA2000 DS

CDMA2000 MC1
 CDMA2000 MC3
 TD-SCDMA
 WLAN 802.11a
 WLAN 802.11b
 WIMAX
 WIBRO
 USER ()
 NADC IS136
 TETRA
 PDC
 PHS
 CDPD



For the R&S ESCI, the channel spacing is defined as the distance between the center frequency of the adjacent channel and the center frequency of the transmission channel. The definition of the adjacent-channel spacing in standards IS95 B and C, IS97 B and C and IS98 B and C is different. These standards define the adjacent-channel spacing from the center of the transmission channel to the closest border of the adjacent channel. This definition is also used for the R&S ESCI when the following standard settings are selected:

CDMA IS95 Class 0 FWD
 CDMA IS95 Class 0 REV
 CDMA IS95 Class 1 FWD
 CDMA IS95 Class 1 REV

The selection of the standard influences the following parameters:

- channel spacing and adjacent-channel spacing
- channel bandwidth, adjacent-channel bandwidth, and type of filtering
- resolution bandwidth
- video bandwidth
- detector
- # of adjacent channels

FAST ACP is not available if a WLAN standard or the WiMAX or WiBro standard is selected.

Trace mathematics and trace averaging are switched off.

The reference level is not influenced by the selection of a standard. To achieve an optimum dynamic range, the reference level has to be set in a way that places the signal maximum close to the reference level without forcing an overload message.

The default setting is *CP/ACP STANDARD NONE*.

As of firmware version 4.4x it is possible to customize ACP User Standards. The user defined ACP standard can be activated via the entry *USER* in the standard selection list. The related configuration file is displayed in brackets. To select another user defined standard, use the softkey *SELECT USER STD*.

Remote command: `CALC:MARK:FUNC:POW:PRES <standard>`

CP/ACP CONFIG

See following section [“Setting the Channel Configuration” on page 4.155](#).

SET CP REFERENCE

With channel power measurement activated, the *SET CP REFERENCE* softkey defines the currently measured channel power as the reference value. The reference value is displayed in the *CH PWR REF* field; the default value is 0 dBm.

The softkey is available only for multi carrier ACP measurements.

In adjacent-channel power measurement with one or several carrier signals, the power is always referenced to a transmission channel, i.e. no value is displayed for *CH PWR REF*.

Remote command: `SENS:POW:ACH:REF:AUTO ONCE`

SWEEP TIME

The *SWEEP TIME* softkey activates the entry of the sweep time. With the RMS detector, a longer sweep time increases the stability of the measurement results.

The function of the softkey is identical to the softkey *SWEEP TIME MANUAL* in the *BW* menu.

Remote command: `SWE:TIME <value>`

NOISE CORR ON | OFF

If the *NOISE CORR ON/OFF* softkey is activated, the results will be corrected by the instrument's inherent noise, which increases the dynamic range.

When the function is switched on, a reference measurement of the instrument's inherent noise is carried out. The noise power measured is then subtracted from the power in the channel that is being examined.

The inherent noise of the instrument depends on the selected center frequency, resolution bandwidth and level setting. Therefore, the correction function is disabled whenever one of these parameters is changed. A disable message is displayed on the screen.

To enable the correction function in conjunction with the changed setting, press the softkey once more. A new reference measurement is carried out.

Remote command: `SENS:POW:NCOR ON`

FAST ACP ON | OFF

The *FAST ACP ON/OFF* softkey switches between the IBW method (*FAST ACP OFF*) and the time domain method (*FAST ACP ON*).

With *FAST ACP ON* the power measurement is performed in the different channels in the time domain. The R&S ESCI sets the center frequency consecutively to the different channel center frequencies and measures the power with the selected measurement time (= sweep time/number of channels). The RBW filters suitable for the selected standard and frequency offset are automatically used (e.g. root raised cos with IS 136).

A list of available filters is included in section [“Filter Types” on page 4.88](#).

The RMS detector is used for obtaining correct power measurement results. Therefore this requires no software correction factors.

Measured values are output as a list. The powers of the transmission channels are output in dBm, the powers of the adjacent channels in dBm (*CP/ACP ABS*) or dB (*CP/ACP REL*).

The sweep time is selected depending on the desired reproducibility of results. Reproducibility increases with sweep time since power measurement is then performed over a longer time period.

As a general approach, it can be assumed that approx. 500 non-correlated measured values are required for a reproducibility of 0.5 dB (99% of the measurements are within 0.5 dB of the true measured value). This holds true for white noise. The measured values are considered as non-correlated when their time interval corresponds to the reciprocal of the measured bandwidth.

With IS 136 the measurement bandwidth is approx. 25 kHz, i.e. measured values at an interval of 40 µs are considered as non correlated. A measurement time of 20 ms is thus required per channel for 1000 measured values. This is the default sweep time which the R&S ESCI sets in coupled mode. Approx. 5000 measured values are required for a reproducibility of 0.1 dB (99%), i.e. the measurement time is to be increased to 200 ms.

Remote command: `SENS:POW:HSP ON`

DIAGRAM FULL SIZE

The *DIAGRAM FULL SIZE* softkey switches the diagram to full screen size.

Remote command: `DISP:WIND1:SIZE LARG|SMAL`

ADJUST REF LVL

The *ADJUST REF LVL* softkey adjusts the reference level of the R&S ESCI to the measured channel power. This ensures that the settings of the RF attenuation and the reference level are optimally adjusted to the signal level without overloading the R&S ESCI or limiting the dynamic range by a too small S/N ratio.

Since the measurement bandwidth for channel power measurements is significantly lower than the signal bandwidth, the signal path may be overloaded although the trace is still significantly below the reference level.

Remote command: `SENS:POW:ACH:PRES:RLEV`

For manual setting of the test parameters different from the settings made with *ADJUST SETTINGS* the following should be observed:

Frequency span

The frequency span must at least cover the channels to be measured plus a measurement margin of 10%.

For channel power measurement, the span is $1.1 \times$ channel bandwidth.



If the frequency span is large in comparison with the channel bandwidth (or the adjacent-channel bandwidths) being examined, only a few points on the trace are available per channel. This reduces the accuracy of the waveform calculation for the channel filter used, which has a negative effect on the measurement accuracy.

We therefore strongly recommend that the formulas mentioned be taken into consideration when selecting the frequency span.

Resolution bandwidth (RBW)

To ensure both an acceptable measurement speed and the required selection (to suppress spectral components outside the channel to be measured, especially of the adjacent channels), the resolution bandwidth must not be selected too small or too large. As a general approach, the resolution bandwidth is to be set to values between 1% and 4% of the channel bandwidth.

A larger resolution bandwidth can be selected if the spectrum within the channel to be measured and around it has a flat characteristic. In the standard setting, e.g. for standard IS95A REV at an adjacent channel bandwidth of 30 kHz, a resolution bandwidth of 30 kHz is used. This yields correct results since the spectrum in the neighborhood of the adjacent channels normally has a constant level. For standard NADC/IS136 this is not possible for example, since the spectrum of the transmit signal penetrates into the adjacent channels and a too large resolution bandwidth causes a too low selection of the channel filter. The adjacent-channel power would thus be measured too high.

With the exception of the IS95 CDMA standards, the *ADJUST SETTINGS* softkey sets the resolution bandwidth (RBW) as a function of the channel bandwidth:

$RBW \leq 1/40$ of channel bandwidth.

The maximum possible resolution bandwidth (with respect to the requirement $RBW \leq 1/40$) resulting from the available RBW steps (1, 3) is selected.

Video bandwidth (VBW)

For a correct power measurement, the video signal must not be limited in bandwidth. A restricted bandwidth of the logarithmic video signal would cause signal averaging and thus result in a too low indication of the power (-2.51 dB at very low video bandwidths). The video bandwidth should therefore be selected at least three times the resolution bandwidth.

The *ADJUST SETTINGS* softkey sets the video bandwidth (VBW) as a function of the channel bandwidth as follows:

$VBW \geq 3 \times RBW$.

The smallest possible VBW with regard to the available step size will be selected.

Detector

The *ADJUST SETTINGS* softkey selects the RMS detector.

The RMS detector is selected since it correctly indicates the power irrespective of the characteristics of the signal to be measured. In principle, the sample detector would be possible as well. Due to the limited number of trace pixels used to calculate the power in the channel, the sample detector would yield less stable results. Averaging, which is often performed to stabilize the measurement results, leads to a too low level indication and should therefore be avoided. The reduction in the displayed power depends on the number of averages and the signal characteristics in the channel to be measured.

SELECT USER STD The softkey *SELECT USER STD* selects and activates a user defined ACP standard.

After selecting the standard, the user defined standard becomes available for selection in the ACP standard list (*USER* list item). The corresponding filename is shown in brackets.

Remote command: `CALC:MARK:FUNC:POW:PRES <standard>`
 `CALC:MARK:FUNC:POW:PRES <file name>`

SAVE AS USER STD

As of firmware version 4.4x, you can save the current ACP configuration in a file and use it as a user defined ACP standard. The data set is stored on the instruments harddisk in XML file format.

Softkey *SAVE AS USER STD* opens a dialog box to store the user defined configuration.

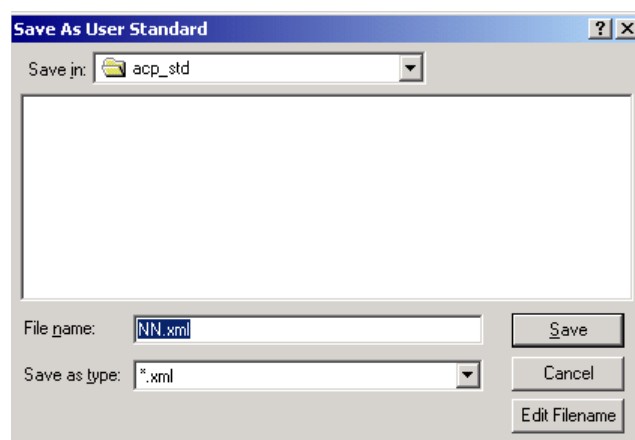

The following list shows the parameters that you can customize:

- Number of Adjacent Channels
- Channel Bandwidth of TX, ADJ and ALT channels
- Channel Spacings
- Resolution Bandwidth, Video Bandwidth
- ACP Limit State and ACP Limits
- Sweeptime, Sweeptime Coupling
- Detector
- Trace Mode (Clr/Write,..)

Note that the ACP User Standard is not supported for Fast ACP and Multi Carrier ACP Measurements.

Remote command: `See`

DELETE USER STD

Opens a dialog box to delete user defined ACP standards.

Remote command: `CALC:MARK:FUNC:POW:STAN:DEL <standard>`

4.6.13.3 Setting the Channel Configuration

CP/ACP CONFIG

NO. OF ADJ CHAN	
NO. OF TX CHAN	
CHANNEL BANDWIDTH	
CHANNEL SPACING	
ACP REF SETTINGS	
CP/ACP ABS REL	
CHAN PWR / HZ	
POWER MODE ↓	CLEAR/WRITE
	MAX HOLD
ADJUST SETTINGS	
Side menu	
ACP LIMIT CHECK	
EDIT ACP LIMITS	
WEIGHTING FILTER	WEIGHT TX ON OFF
	WEIGHT TX ALPHA
	WEIGHT ADJ ON OFF
	WEIGHT ADJ ALPHA
SELECT TRACE	

The *CP/ACP CONFIG* softkey opens a submenu for configuration of the channel power and adjacent channel power measurement independently of the offered standards.

The channel configuration includes the number of channels to be measured, the channel bandwidths (*CHANNEL BANDWIDTH*), and the channel spacings (*CHANNEL SPACING*).

Limit values can additionally be specified for the adjacent-channel power (*ACP LIMIT CHECK* and *EDIT ACP LIMITS*) which are checked for compliance during the measurement.

NO. OF ADJ CHAN

The *NO. OF ADJ CHAN* softkey activates the entry of the number $\pm n$ of adjacent channels to be considered in the adjacent-channel power measurement.

Numbers from 0 to 12 can be entered.

The following measurements are performed depending on the number of the channels.

- 0 Only the channel powers are measured.
- 1 The channel powers and the power of the upper and lower adjacent channel are measured.
- 2 The channel powers, the power of the upper and lower adjacent channel and of the next higher and lower channel (alternate channel 1) are measured.

- 3 The channel power, the power of the upper and lower adjacent channel, the power of the next higher and lower channel (alternate channel 1) and of the next but one higher and lower adjacent channel (alternate channel 2) are measured.

With higher numbers the procedure is expanded accordingly.

Remote command: `SENS:POW:ACH:ACP 1`

This increased number of adjacent channels is realized for all the relevant settings like:

```

ACLR LIMIT CHECK :CALC:LIM:ACP:ACH:RES?
                  :CALC:LIM:ACP:ALT1..11:RES?

EDIT ACLR LIMITS :CALC:LIM:ACP:ACH:STAT ON
                  :CALC:LIM:ACP:ACH:ABS -10dBm,-10dBm
                  :CALC:LIM:ACP:ACH:ABS:STAT ON
                  :CALC:LIM:ACP:ALT1..11 0dB,0dB
                  :CALC:LIM:ACP:ALT1..11:STAT ON
                  :CALC:LIM:ACP:ALT1..11:ABS -10dBm,-10dBm
                  :CALC:LIM:ACP:ALT1..11:ABS:STAT ON

ADJ CHAN          :SENS:POW:ACH:BWID:ALT1..11 30kHz
BANDWIDTH

ADJ CHAN SPACING :SENS:POW:ACH:SPAC:ALT1..11 4MHz

```

NO. OF TX CHAN The *NO. OF TX CHAN* softkey enables the entry of the number of carrier signals to be considered in channel and adjacent-channel power measurements.

Numbers from 1 to 12 can be entered.

The softkey is available only for multi carrier ACP measurements.

Remote command: `SENS:POW:ACH:TXCH:COUN 12`

CHANNEL BANDWIDTH The *CHANNEL BANDWIDTH* softkey opens a table for defining the channel bandwidths for the transmission channels and the adjacent channels.

TX/ACP CHANNEL BW	
CHAN	BANDWIDTH
TX	14 kHz
ADJ	14 kHz
ALT1	14 kHz
ALT2	14 kHz
ALT3	14 kHz
ALT4	14 kHz
ALT5	14 kHz
ALT6	14 kHz
ALT7	14 kHz
ALT8	14 kHz
ALT9	14 kHz
ALT10	14 kHz
ALT11	14 kHz

The transmission-channel bandwidth is normally defined by the transmission standard. The correct bandwidth is set automatically for the selected standard (see *CP/ACP STANDARD* softkey).

With the IBW method (*FAST ACP OFF*), the channel bandwidth limits are marked by two vertical lines right and left of the channel center frequency. It can in this way be visually checked whether the entire power of the signal under test is within the selected channel bandwidth.

Measurements in the time domain (*FAST ACP ON*) are performed in the zero span mode. The channel limits are indicated by vertical lines. For measurements requiring channel bandwidths deviating from those defined in the selected standard the IBW method is to be used.

Refer to section [“Filter Types” on page 4.88](#) for a list of available filters.

When measuring according to the IBW method (*FAST ACP OFF*) the bandwidths of the different adjacent channels are to be entered numerically. Since all adjacent channels often have the same bandwidth, the other channels Alt1 and Alt2 are set to the bandwidth of the adjacent channel on entering the adjacent-channel bandwidth (ADJ). Thus only one value needs to be entered in case of equal adjacent channel bandwidths. The same holds true for the ALT2 channels (alternate channels 2) when the bandwidth of the ALT1 channel (alternate channel 1) is entered.



The channel spacings can be set separately by overwriting the table from top to bottom.

The entry "TX" is only available for the multi carrier ACP measurement.

Remote command: SENS:POW:ACH:BWID:CHAN 14kHz
 SENS:POW:ACH:BWID:ACH 1kHz
 SENS:POW:ACH:BWID:ALT1 14kHz
 SENS:POW:ACH:BWID:ALT2 14kHz

CHANNEL
SPACING

The *CHANNEL SPACING* softkey opens a table for defining the channel spacings for the TX channels as well as for the adjacent channels.



The entry "TX" is only available for the multi carrier ACP measurement.

TX channels

The spacing between every TX channels can be defined separately. Therefore a TX spacing 1-2 for the spacing between the first and the second carrier, a TX spacing 2-3 for the spacing between the second and the third carrier and so on can be defined. In order to allow a convenient setup for the system with equal TX channel spacing, the value of TX spacing 1-2 will be copied in all the spacing below after entry, the TX spacing 2-3 will be copied in all the spacing below after entry and so forth.



For different spacings, a setup from top to bottom is necessary.

If the spacings are not equal, the channel distribution according to the center frequency is as follows:

- Odd number of TX channels:
The middle TX channel is centered to center frequency.
- Even number of TX channels:
The two TX channels in the middle are used to calculate the frequency between those two channels. This frequency is aligned to the center frequency.

TX/ACP CHANNEL SPACING	
CHAN	SPACING
TX1-2	20 kHz
TX2-3	20 kHz
TX3-4	20 kHz
TX4-5	20 kHz
TX5-6	20 kHz
TX6-7	20 kHz
TX7-8	20 kHz
TX8-9	20 kHz
TX9-10	20 kHz
TX10-11	20 kHz
TX11-12	20 kHz
ADJ	20 kHz
ALT1	40 kHz
ALT2	60 kHz
ALT3	80 kHz
ALT4	100 kHz
ALT5	120 kHz
ALT6	140 kHz
ALT7	160 kHz
ALT8	180 kHz
ALT9	200 kHz
ALT10	220 kHz
ALT11	240 kHz

Adjacent channels

Since all the adjacent channels often have the same distance to each other, the entry of the adjacent-channel spacing (ADJ) causes channel spacing ALT1 to be set to twice and channel spacing ALT2 to three times the adjacent-channel spacing (and so on). Thus only one value needs to be entered in case of equal channel spacing. The same holds true for the ALT2 channels when the bandwidth of the ALT1 channel is entered.



The channel spacings can be set separately by overwriting the table from top to bottom.

If the ACP or MCACP measurement is started, all settings according to the standard including the channel bandwidths and channel spacings are set and can be adjusted afterwards.

Remote command: : SENS:POW:ACH:SPAC:CHAN 20kHz
 : SENS:POW:ACH:SPAC:ACH 20kHz
 : SENS:POW:ACH:SPAC:ALT1 40kHz
 : SENS:POW:ACH:SPAC:ALT2 60kHz

ACP REF SETTINGS The *ACP REF SETTINGS* softkey opens a table for selecting the transmission channel to which the adjacent-channel relative power values should be referenced.

ACP REFERENCE CHANNEL	
✓	TX CHANNEL 1
	TX CHANNEL 2
	TX CHANNEL 3
	TX CHANNEL 4
	TX CHANNEL 5
	TX CHANNEL 6
	TX CHANNEL 7
	TX CHANNEL 8
	TX CHANNEL 9
	TX CHANNEL 10
	TX CHANNEL 11
	TX CHANNEL 12
	MIN POWER TX CHANNEL
	MAX POWER TX CHANNEL
	LOWEST & HIGHEST CHANNEL

TX CHANNEL 1 - 12	Selection of one of the channels.
MIN POWER TX CHANNEL	The transmission channel with the lowest power is used as a reference channel.
MAX POWER TX CHANNEL	The transmission channel with the highest power is used as a reference channel.
LOWEST & HIGHEST CHANNEL	The outer left hand transmission channel is the reference channel for the lower adjacent channels, the outer right hand transmission channel that for the upper adjacent channels.

The softkey is available only for multi carrier ACP measurements.

Remote command: SENS:POW:ACH:REF:TXCH:MAN 1
 SENS:POW:ACH:REF:TXCH:AUTO MIN

**CP/ACP
ABS | REL** The *CP/ACP ABS/REL* softkey (channel power absolute/relative) switches between absolute and relative power measurement in the channel.

CP/ACP ABS The absolute power in the transmission channel and in the adjacent channels is displayed in the unit of the y-axis, e.g. in dBm, dBmV.

CP/ACP REL For adjacent-channel power measurements (*NO. OF ADJ CHAN > 0*), the level of the adjacent channels is displayed relative to the level of the transmission channel in dBc.

For channel power measurements (*NO. OF ADJ CHAN = 0*) with a single carrier, the power of the transmission channel is displayed relative to the power of a reference channel defined by *SET CP REFERENCE*. This means:

1. Declare the power of the currently measured channel as the reference value, using the *SET CP REFERENCE* softkey.
2. Select the channel of interest by varying the channel frequency (R&S ESCI center frequency).

With linear scaling of the y-axis, the power of the new channel relative to the reference channel (CP/CP_{ref}) is displayed. With dB scaling, the logarithmic ratio $10\lg(CP/CP_{ref})$ is displayed.

The relative channel power measurement can thus also be used for universal adjacent-channel power measurements. Each channel can be measured individually.

Remote command: `SENS:POW:ACH:MODE ABS`

CHAN PWR / HZ The *CHAN PWR / HZ* softkey toggles between the measurement of the total channel power and the measurement of the channel power referenced to a 1-Hz bandwidth.

The conversion factor is $10 \cdot \lg \frac{1}{\text{Channel Bandwidth}}$

By means of this function it is possible e.g. to measure the signal/noise power density or use the additional functions *CP/ACP REL* and *SET CP REFERENCE* to obtain the signal to noise ratio.

Remote command: `CALC:MARK:FUNC:POW:RES:PHZ ON|OFF`

POWER MODE The *POWER MODE* softkey opens the submenu for selecting the power mode.

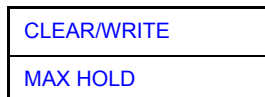

CLEAR/WRITE In the *CLEAR/WRITE* mode the channel power and the adjacent channel powers are calculated directly from the current trace (default mode).

MAX HOLD In *MAX HOLD* mode the power values are still derived from the current trace, but they are compared with the previous power value using a maximum algorithm. The higher value is remained.

MAX HOLD mode is only applicable if the number of adjacent channels is > 0

Remote command: `CALC:MARK:FUNC:POW:MODE WRIT|MAXH`

ADJUST SETTINGS The *ADJUST SETTINGS* softkey automatically optimizes the instrument settings for the selected power measurement (see below).

All instrument settings relevant for a power measurement within a specific frequency range (channel bandwidth) are optimized for the selected channel configuration (channel bandwidth, channel spacing):

- Frequency span:

The frequency span should cover at least all channels to be considered in a measurement.

For channel power measurements, the frequency span is set as follows:

$$(\text{No. of transmission channels} - 1) \times \text{transmission channel spacing} + 2 \times \text{transmission channel bandwidth} + \text{measurement margin}$$

For adjacent-channel power measurements, the frequency span is set as a function of the number of transmission channels, the transmission channel spacing, the adjacent-channel spacing, and the bandwidth of one of adjacent-channels ADJ, ALT1 or ALT2, whichever is furthest away from the transmission channels:

$$(\text{No. of transmission channels} - 1) \times \text{transmission channel spacing} + 2 \times (\text{adjacent-channel spacing} + \text{adjacent-channel bandwidth}) + \text{measurement margin}$$

The measurement margin is approx. 10% of the value obtained by adding the channel spacing and the channel bandwidth.

- Resolution bandwidth: $\text{RBW} \leq 1/40$ of channel bandwidth
- Video bandwidth: $\text{VBW} \geq 3 \times \text{RBW}$
- Detector: RMS detector

Trace math and trace averaging functions are switched off.

The reference level is not influenced by *ADJUST SETTINGS*. It can be separately adjusted with *ADJUST REF LVL*.

The adjustment is carried out only once; if necessary, the instrument settings can be changed later.

Remote command: `SENS:POW:ACH:PRES ACP|CPOW|MCAC|OBW`

ACP LIMIT CHECK The *ACP LIMIT CHECK* softkey switches the limit check for the ACP measurement on and off.

Remote command: `CALC:LIM:ACP ON`
 `CALC:LIM:ACP:ACH:RES?`
 `CALC:LIM:ACP:ALT:RES?`

EDIT ACP LIMITS The *EDIT ACP LIMITS* softkey opens a table for defining the limits for the ACP measurement.

ACP LIMITS				
CHAN	RELATIVE LIMIT CHECK		ABSOLUTE LIMIT CHECK	
	VALUE	ON	VALUE	ON
ADJ	-45 dB	√		
ALT1	-60 dB	√		
ALT2				
ALT3				
ALT4				
ALT5				
ALT6				
ALT7				
ALT8				
ALT9				
ALT10				
ALT11				

The following rules apply for the limits:

- A separate limit can be defined for each adjacent channel. The limit applies to both the upper and the lower adjacent channel.
- A relative and/or absolute limit can be defined. The check of both limit values can be activated independently.
- The R&S ESCI checks adherence to the limits irrespective of whether the limits are absolute or relative or whether the measurement is carried out with absolute or relative levels. If both limits are active and if the higher of both limit values is exceeded, the measured value is marked accordingly.



Measured values exceeding the limit are marked by a preceding asterisk.

Remote command:

```

CALC:LIM:ACP ON
CALC:LIM:ACP:ACH 0dB,0dB
CALC:LIM:ACP:ACH:STAT ON
CALC:LIM:ACP:ACH:ABS -10dBm,-10dBm
CALC:LIM:ACP:ACH:ABS:STAT ON
CALC:LIM:ACP:ALT1 0dB,0dB
CALC:LIM:ACP:ALT1:STAT ON
CALC:LIM:ACP:ALT1:ABS -10dBm,-10dBm
CALC:LIM:ACP:ALT1:ABS:STAT ON
CALC:LIM:ACP:ALT2 0dB,0dB
CALC:LIM:ACP:ALT2:STAT ON
CALC:LIM:ACP:ALT2:ABS -10dBm,-10dBm
CALC:LIM:ACP:ALT2:ABS:STAT ON

```

WEIGHTING FILTER Opens a submenu to control the weighting filter.

Some of the digital standards specify weighting filters to be taken into account. In that case the required filter is automatically activated by the selection of the ACP standard.

As of firmware version 4.4x, the weighting filter parameters can be manually controlled for NORMAL ACP measurements. To change the weighting filter settings when using predefined standards, proceed as follows:

- Select the predefined standard with the **CP/ACP STANDARD** softkey.
- Save the settings as a user defined standard with the **SAVE AS USER STD** softkey.
- Select the user defined standard you just saved with the **SELECT USER STD** softkey.
- Since the standard in use is now a user defined standard, you can change the weighting filter settings as required.
- Save the user standard again to keep the current settings.

Weighting filters are not available for FAST ACP measurements and for Multi Carrier ACP measurements.

WEIGHT TX ON OFF	<p>Activates and deactivates the weighting filter for the TX channel.</p> <p>Note that most of the standards require identical settings for all channels.</p> <p>Remote command: POW:ACH:FILT:STAT:ALL ON POW:ACH:FILT:STAT:CHAN ON</p>
WEIGHT TX ALPHA	<p>Defines the roll-off factor of the weighting filter for the TX channel.</p> <p>Remote command: POW:ACH:FILT:ALPH:ALL 0.3 POW:ACH:FILT:ALPH:CHAN 0.3</p>
WEIGHT ADJ ON OFF	<p>Activates and deactivates the weighting filter for adjacent and alternate channels.</p> <p>.Note that most of the standards require identical settings for all channels.</p> <p>Remote command: POW:ACH:FILT:STAT:ACH OFF POW:ACH:FILT:STAT:ALT ON</p>
WEIGHT ADJ ALPHA	<p>Defines the roll-off factor of the weighting filter for adjacent and alternate channels.</p> <p>Remote command: POW:ACH:FILT:ALPH:ACH 0.3 POW:ACH:FILT:ALPH:ALT 0.3</p>
ADJ REFLVL OFFSET	<p>Defines an additional level offset to the measured mean power to be taken into account for the analyzer's reference level setting.</p> <p>It is a modification to the ADJUST REF LEVEL function specific to user standards.</p> <p>Proceed as follows to adjust the offset value for a predefined standard:</p> <ul style="list-style-type: none"> ➤ Select a predefined standard with the CP/ACP STANDARD ➤ Create a new user standards with SAVE AS USER STD ➤ Select the user standard you just created with SELECT USER STD ➤ Change the offset ➤ Save the user standard again to keep the current settings. <p>Remote command: POW:ACH:PRES:RLEV:OFFS 10dB</p>

SELECT TRACE The *SELECT TRACE* softkey selects the trace on which the CP/ACP measurement is to be performed. Only activated traces can be selected, i.e. traces not set to BLANK.

Remote command: SENS:POW:TRAC 1

Examples

Measurement of adjacent-channel power for a specific standard:

The adjacent-channel power is to be measured for a signal at 800 MHz with 0 dBm level in line with IS136.

[PRESET]	Set the R&S ESCI to the default setting.
[FREQ: CENTER: 800 MHz]	Set the center frequency to 800 MHz.
[AMPT: 0 dBm]	Set the reference level to 0 dBm.
[MEAS]	Call the menu for the measurement functions.
[CHAN PWR / ACP]	Select the channel and adjacent-channel power measurement function. The measurement is performed with the default settings or a previously defined setting. The submenu for setting the desired new configuration is opened.
[CP/ACP STANDARD: select IS136: ENTER]	Select the NADC (IS136) standard.
[CP/ACP CONFIG]	Call the submenu for configuration of the adjacent-channel power measurement.
[NO. OF ADJ CHAN: 2 ENTER]	Select two adjacent channels for the measurement, i.e. the adjacent channel and the alternate channel are measured.
[ADJUST SETTINGS]	Set the optimum span, resolution bandwidth (RBW), video bandwidth (VBW) and detector automatically for the measurement. The absolute channel power and the relative power of the adjacent channels are displayed on the screen.
	Change to the main menu for channel power measurement.
[ADJUST REF LVL]	Set the reference level equal to the channel power measured.

Measurement with user-specific channel configuration:

Measurement of the adjacent-channel power ratio (ACPR) of an IS95 CDMA signal at 800 MHz, level 0 dBm. Similar to example 1, the setting can be simplified by using *CP/ACP STANDARD*.

[PRESET]	Set the R&S ESCI to the default setting.
[FREQ: CENTER: 800 MHz]	Set the center frequency to 800 MHz.
[AMPT: 0 dBm]	Set the reference level to 0 dBm.
[MEAS]	Call the menu for the measurement functions.

[*CHAN PWR / ACP*] Select the channel and adjacent-channel power measurement function. The measurement is carried out with the default settings or a previously defined setting. The submenu for setting the desired new configuration is opened.

[*CP/ACP CONFIG*] Call the submenu for defining the channel configuration.

[*NO. OF ADJ CHAN: 2 ENTER*] Select two adjacent channels for the measurement, i.e. the adjacent channel and the alternate channel are measured.

[*CHANNEL BANDWIDTH: 1.23 MHz*: with IS 95. Set the adjacent-channel bandwidth to 30 kHz.

: 30 kHz]

TX/ACP CHANNEL BW	
CHAN	BANDWIDTH
TX	1.23 MHz
ADJ	30 kHz
ALT1	30 kHz
ALT2	30 kHz

Upon entry of 30 kHz for the adjacent channel the alternate channels are also set to 30 kHz.

[*CHAN SPACING: 1.25 MHz*: 885 kHz: - 1.98 MHz] : 2.97 MHz]

TX/ACP CHAN SPACING	
CHAN	SPACING
TX	1.25 MHz
ADJ	885 kHz
ALT1	1.98 MHz
ALT2	2.97 MHz

Upon entry of 885 kHz for the adjacent channel the channels ALT1 and ALT2 are set to 1770 kHz and 2655 kHz. Upon entry of 1.98 MHz for the alternate channel 1 the alternate channel 2 is set to 2.97 MHz.

[*ADJUST SETTINGS*] Automatically set the optimum span (= 5 MHz), resolution bandwidth (RBW = 30 kHz), video bandwidth (VBW = 300 kHz) and detector (RMS) for the measurement. The absolute channel power and the relative power of the adjacent channels and alternate channels are displayed on the screen.

Go to the main menu for channel power measurement.

[*ADJUST REF LVL*] Set the reference level equal to the channel power measured.

Measurement of signal/noise power density (C/No) of an IS95 CDMA signal (frequency 800 MHz, level 0 dBm)

[*PRESET*] Set the R&S ESCI to the default setting.

[*FREQ: CENTER: 800 MHz*] Set the center frequency to 800 MHz.

[*AMPT: 0 dBm*] Set the reference level to 0 dBm.

[*MEAS*] Call the menu for the measurement functions.

[<i>CHAN PWR / ACP</i>]	Select the channel and adjacent-channel power measurement. The measurement is performed with the default setting or a previously defined setting. The submenu for setting the desired new configuration is opened.
[<i>CP/ACP CONFIG</i>]	Call the submenu for defining the channel configuration.
[<i>NO. OF ADJ CHAN: 0</i> ENTER]	Do not select an adjacent channel for the measurement, i.e. the measurement is carried out in one channel only.
[<i>CHANNEL</i> <i>BANDWIDTH: 1.23 MHz</i>]	Set the channel bandwidth to 1.23 MHz in line with IS95.
[<i>ADJUST SETTINGS</i>]	Set the optimum span (= 5 MHz), resolution bandwidth (RBW = 30 kHz), video bandwidth (VBW = 300 kHz) and detector (RMS) for the measurement automatically. The absolute channel power and the relative power of the adjacent channels and alternate channels are displayed on the screen.
	Go to the main menu for channel power measurement
[<i>ADJUST REF LVL</i>]	Set the reference level equal to the channel power measured.
[<i>SET CP REFERENCE</i>]	Set the measured channel power as a reference for the subsequent measurements.
[<i>CP/ACP ABS / REL</i>]	Select relative measurement related to the reference power set with <i>SET REFERENCE</i> (result 0 dB).
[<i>CHAN PWR / HZ</i>]	Select power measurement related to 1 Hz bandwidth (result -60.9 dB).
[FREQ: CENTER: 805 MHz]	Set the center frequency to 805 MHz. The R&S ESCI measures the channel power at 1.23 MHz bandwidth and outputs the result in dB relative to the reference power and 1 Hz bandwidth.

Measurement of Occupied Bandwidth

An important characteristics of a modulated signal is its occupied bandwidth. In a radio communications system for instance the occupied bandwidth must be limited to enable distortion-free transmission in adjacent channels. The occupied bandwidth is defined as the bandwidth containing a defined percentage of the total transmitted power. A percentage between 10% and 99.9% can be set on the R&S ESCI.

OCCUPIED BANDWIDTH

OCCUP BW ON OFF
% POWER BANDWIDTH
CHANNEL BANDWIDTH
ADJUST REF LVL
ADJUST SETTINGS

The *OCCUPIED BANDWIDTH* softkey activates measurement of the occupied bandwidth according to the current configuration and opens the submenu for configuring the measurement. The softkey is available only in frequency domain (span > 0) and is highlighted when the measurement is switched on.

In the spectrum display mode, this measurement determines the bandwidth that contains a predefined percentage of the power of the displayed frequency range (*% POWER BANDWIDTH* softkey). The occupied bandwidth is output in the marker display field and marked on the trace by temporary markers.



- The softkey is only available in the frequency domain (span > 0).
- The measurement is performed on the trace with marker 1. In order to evaluate another trace, marker 1 must be placed on another trace by means of *SELECT TRACE* in the *MARKER* menu

OCCUP BW ON | OFF

The *OCCUP BW ON/OFF* softkey switches measurement of the occupied bandwidth on or off.

Remote command: `CALC:MARK:FUNC:POW:SEL OBW`
`CALC:MARK:FUNC:POW:RES? OBW`
`CALC:MARK:FUNC:POW OFF`

% POWER BANDWIDTH

The *% POWER BANDWIDTH* softkey opens the entry of the percentage of power related to the total power in the displayed frequency range which defines the occupied bandwidth (percentage of total power).

The valid range of values is 10% to 99.9%.

Remote command: `SENS:POW:BWID 99PCT`

CHANNEL BANDWIDTH

The *CHANNEL BANDWIDTH* softkey opens an input window for defining the channel bandwidth for the transmission channel. For measurements in line with a specific transmission standard, the bandwidth specified by the standard for the transmission channel must be entered.

The default setting is 14 kHz.

The specified channel bandwidth is used for optimization of the test parameters of the R&S ESCI with *ADJUST SETTINGS*.

Remote command: `SENS:POW:ACH:BWID 14kHz`

ADJUST REF LVL

The *ADJUST REF LVL* softkey adjusts the reference level of the R&S ESCI to the measured total power of the signal. The softkey is activated after the first sweep with the measurement of the occupied bandwidth has been completed and the total power of the signal is thus known.

Adjusting the reference level ensures that the signal path of the R&S ESCI will not be overloaded and the dynamic range not limited by too low a reference level.

Since the measurement bandwidth for channel power measurements is significantly lower than the signal bandwidth, the signal path may be overloaded although the trace is distinctly below the reference level. If the measured channel power is equal to the reference level, the signal path cannot be overloaded.

Remote command: `SENS:POW:ACH:PRES:RLEV`

ADJUST SETTINGS

The *ADJUST SETTINGS* softkey optimizes the instrument settings for the measurement of the occupied bandwidth according to the specified channel bandwidth.

All instrument settings relevant for power measurement within a specific frequency range are optimized:

- frequency span: $3 \times$ channel bandwidth
- resolution bandwidth: $RBW \leq 1/40$ of channel bandwidth
- video bandwidth: $VBW \geq 3 \times RBW$
- detector: RMS

The reference level is not influenced by *ADJUST SETTINGS*. For an optimum dynamic range it should be selected in a way that the signal maximum is close to the reference level.

The adjustment is carried out only once; if necessary, the instrument settings may be changed later.

Remote command: `SENS:POW:PRES OBW`

Measurement principle

For example, the bandwidth containing 99% of the signal power is to be determined. The routine first calculates the total power of all displayed points of the trace. In the next step, the points from the right edge of the trace are summed up until 0.5% of the total power is reached. Auxiliary marker 1 is positioned at the corresponding frequency. Then the R&S ESCI sums up the points from the left edge of the trace until 0.5% of the power is reached. Auxiliary marker 2 is positioned at this point. 99% of the power is now between the two markers. The distance between the two frequency markers is the occupied bandwidth which is displayed in the marker info field.

A prerequisite for correct measurement is that only the signal to be measured is visible on the screen of the R&S ESCI. An additional signal would invalidate the measurement.

To ensure correct power measurement especially for noise signals and to obtain the correct occupied bandwidth, the following settings should be selected:

RBW	<< occupied bandwidth (approx. 1/20 of occupied bandwidth, for voice communication type. 300 Hz or 1 kHz)
VBW	$\geq 3 \times$ RBW
Detector	RMS or sample
Span	≥ 2 to $3 \times$ occupied bandwidth

Some of the measurement specifications (e.g. PDC, RCR STD-27B) require measurement of the occupied bandwidth using a peak detector. The detector setting of the R&S ESCI has to be changed accordingly then.

Example

Measurement of occupied bandwidth of a PDC signal at 800 MHz, level 0 dBm

[PRESET]	Set the R&S ESCI to the default setting.
[FREQ: CENTER: 800 MHz]	Set the center frequency to 800 MHz.
[AMPT: 0 dBm]	Set the reference level to 0 dBm.
[MEAS]	Call the menu for the measurement functions.
[OCCUPIED BANDWIDTH]	Select measurement of the occupied bandwidth and open the submenu for configuring the measurement.
[% POWER BANDWIDTH: 99%]	Select 99% for the bandwidth to be measured.
[CHANNEL BANDWIDTH: 21 kHz]	Enter the channel bandwidth of 21 kHz specified by PDC.
[ADJUST SETTINGS]	Optimize the measurement parameters for the specified channel bandwidth. Allow for a complete frequency sweep so that the R&S ESCI can determine the total signal power.
[ADJUST REF LVL]	Adjust the reference level to the measured signal power.
[TRACE: DETECTOR: DETECTOR MAX PEAK]	PDC requires measurement of the occupied bandwidth using a peak detector. Therefore, switch on the peak detector instead of the RMS detector selected by <i>ADJUST SETTINGS</i> .

4.6.13.4 Measurement of Signal Amplitude Statistics

Digital modulated signals are similar to white noise within the transmit channel, but are different in their amplitude distribution. In order to transmit the modulated signal without distortion all amplitudes of the signal have to be transmitted linearly, e.g. from the output power amplifier. Most critical are the peak amplitude values, of course.

Degradation in transmit quality caused by a transmitter two port network is dependent on the amplitude of the peak values as well as on their probability.

The probability of amplitude values can be measured with the APD function (Amplitude Probability Distribution). During a selectable measurement time all occurring amplitude values are assigned to an amplitude range. The number of amplitude values in the specific ranges is counted and the result is displayed as a histogram. Each bar of the histogram represents the percentage of measured amplitudes within the specific amplitude range.

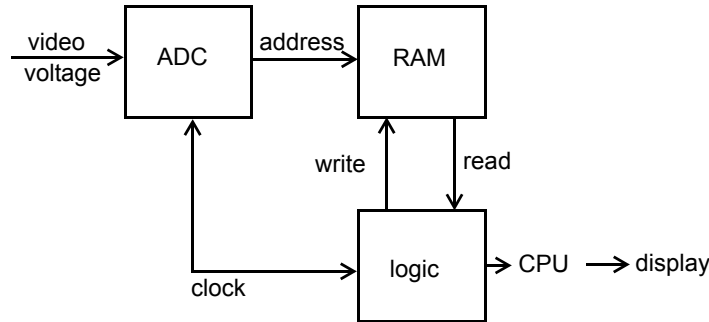

Fig. 4.11 Simplified block diagram for APD measurement

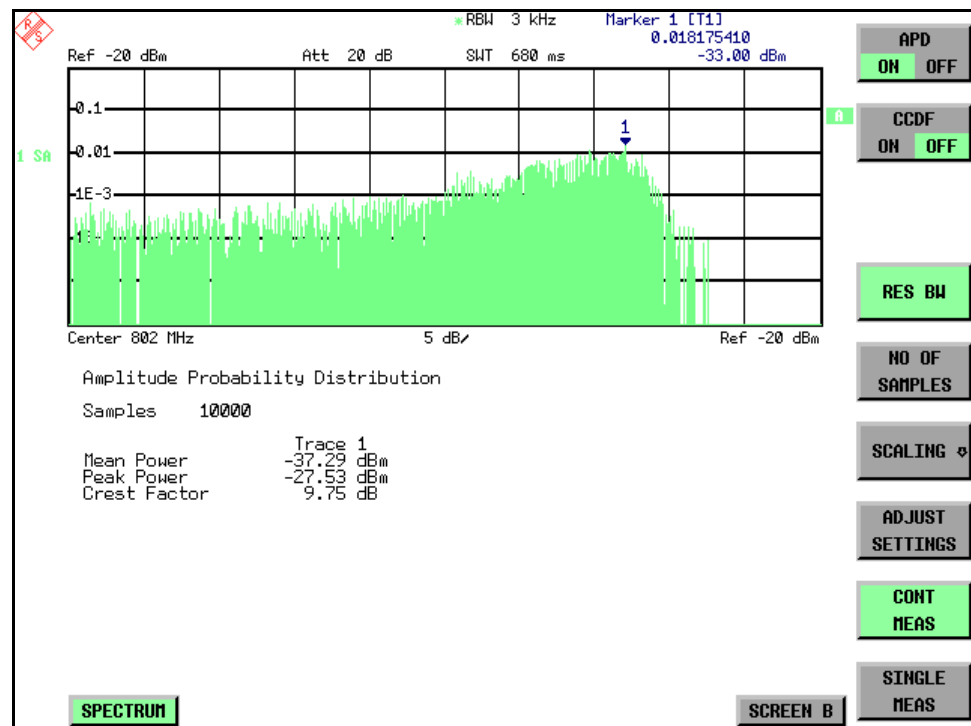

Fig. 4.12 Display of the amplitude probability distribution

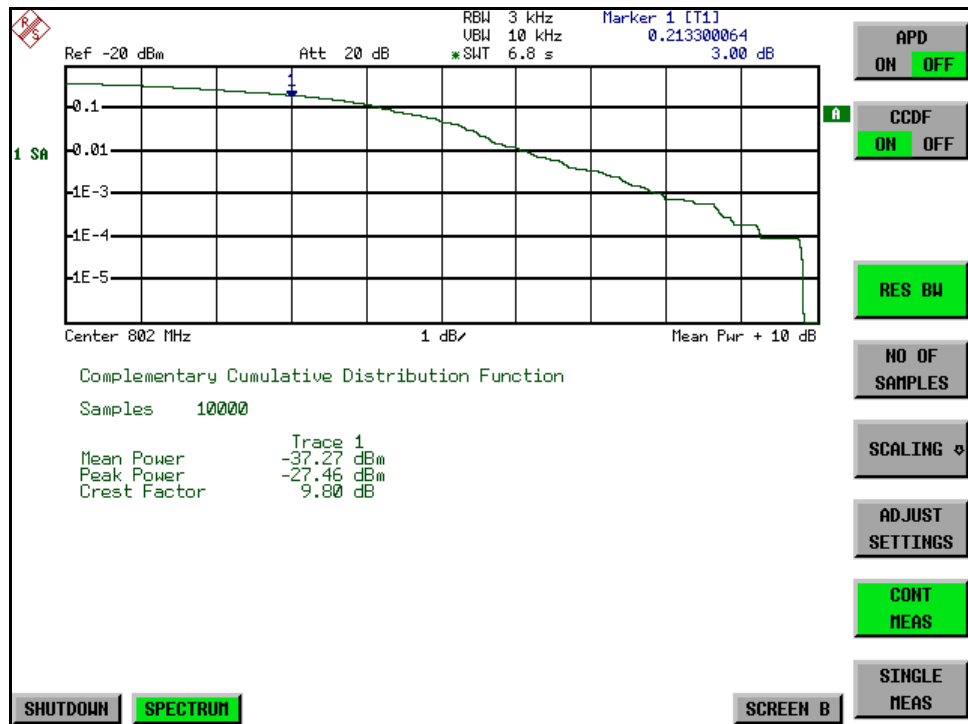

Fig. 4.13 Display of the complementary cumulative distribution function (CCDF)

Alternate to the histogram display of the APD the Complementary Cumulative Distribution Function (CCDF) can be displayed. It shows the probability of an amplitude exceeding a specific value.

For the APD function the x-axis is scaled in absolute values in dBm, whereas for the CCDF function the x-axis is scaled relative to the MEAN POWER measured.

Definitions:

Crest factor = peak voltage to rms

CCDF = complementary cumulative distribution function



During an active statistic measurement, the functions FULL SCREEN, SPLIT SCREEN and selection of the active diagram via the SCREEN A / SCREEN B hotkeys are disabled.

SIGNAL STATISTIC

The *SIGNAL STATISTIC* softkey opens a submenu for measurement of signal statistics.

APD ON OFF	
CCDF ON OFF	
PERCENT MARKER	
RES BW	
NO OF SAMPLES	
SCALING ↓	X-AXIS REF LEVEL
	X-AXIS RANGE
	Y-UNIT %/ABS

	Y-AXIS MAX VALUE
	Y-AXIS MIN VALUE
	ADJUST SETTINGS
	DEFAULT SETTINGS
	MEAN PWR POSITION
ADJUST SETTINGS	
CONT MEAS	
SINGLE MEAS	
Side menu	
GATED TRIGGER	
GATE RANGES	

In the submenu measurement of amplitude probability density (*APD*) and complementary cumulative distribution (*CCDF*) can be selected alternately. Only one of the signal statistic functions can be switched on at a time.

In default mode all statistic functions are switched off.

With a statistic function switched on the R&S ESCI is set into zero span mode automatically.

The R&S ESCI measures the statistics of the signal applied to the RF input with the resolution bandwidth set. In order not to influence the peak amplitudes the video bandwidth is automatically set to 10 times the resolution bandwidth. The sample detector is used for detecting the video voltage.

APD ON | OFF The *APD ON/OFF* softkey switches on or off the amplitude probability distribution function. When the APD function is switched on, the CCDF function is switched off automatically.

Remote command: `CALC:STAT:APD ON`

CCDF ON | OFF The *CCDF ON/OFF* softkey switches on or off the complementary cumulative distribution function. When the CCDF function is switched on, the APD function is switched off automatically.

Remote command: `CALC:STAT:CCDF ON`

PERCENT MARKER If the CCDF function is active, the *PERCENT MARKER* softkey allows to position marker 1 by entering a probability value. Thus, the power which is exceeded with a given probability can be determined very easily.

If marker 1 is in the switched-off state, it will be switched on automatically.

Remote command: `CALC:MARK:Y:PERC 0...100%`

RES BW The *RES BW* softkey sets the resolution bandwidth in the menu *STATISTIC FUNCTION* directly without switching to the corresponding menu (*BW*). The function of the softkey is identical to the softkey *RES BW MANUAL* in the *BW* menu.

For correct measurement of the signal statistics the resolution bandwidth has to be wider than the signal bandwidth in order to transmit the actual peaks of the signal amplitude correctly. Video bandwidth is set to 10 MHz automatically with a statistic function switched on.

Remote command: `BAND 3 MHz`

NO OF SAMPLES The *NO OF SAMPLES* softkey sets the number of power measurements taken into account for the statistics.

Please note that the overall measurement time is influenced by the number of samples selected as well as by the resolution bandwidth set up for the measurement as the resolution bandwidth directly influences the sampling rate.

Remote command: `CALC:STAT:NSAM <value>`

SCALING The *SCALING* softkey opens a submenu that allows changing the scaling parameters for both the x- and the y-axis.

X-AXIS REF LEVEL
X-AXIS RANGE
Y-UNIT %/ABS
Y-AXIS MAX VALUE
Y-AXIS MIN VALUE
ADJUST SETTINGS
DEFAULT SETTINGS
MEAN PWR POSITION

X-AXIS REF LEVEL The *X-AXIS REF LEVEL* softkey changes the level settings of the instrument and sets the maximum power to be measured.

The function is identical to softkey *REF LEVEL* in *AMPT* menu.

For the *APD* function this value is mapped to the right diagram border. For the *CCDF* function there is no direct representation of this value on the diagram as the x-axis is scaled relatively to the *MEAN POWER* measured.

Remote command: `CALC:STAT:SCAL:X:RLEV <value>`

X-AXIS RANGE The *X-AXIS RANGE* softkey changes the level range to be covered by the statistics measurement selected.

The function is identical to softkey *RANGE LOG MANUAL* in *AMPT* menu.

Remote command: `CALC:STAT:SCAL:X:RANG <value>`

Y-UNIT %/ABS The softkey *Y-UNIT %/ABS* defines the scaling type on the y-axis. The default case are the absolute probability. This can be changed to percent values. The softkeys *Y-AXIS MIN* and *Y-AXIS MAX* are using values based on the *Y-UNIT* setting.

Remote command: `CALC:STAT:SCAL:Y:UNIT PCT | ABS`

The 0.01%, 0.1%, 1% and 10% value from the CCDF measurement are shown in the bottom screen half. Those values can also queried via remote:

Remote command: `CALC:STAT:CCDF:X? P0_01 | P0_1 | P1 | P10`

Y-AXIS MAX VALUE The *Y-AXIS MAX VALUE* softkey defines the upper limit of the displayed probability range.

Values on the y-axis are normalized which means that the maximum value is 1.0. As the y-axis scaling has a logarithmic axis the distance between max and min value must be at least one decade.

Remote command: `CALC:STAT:SCAL:Y:UPP <value>`

Y-AXIS MIN VALUE The *Y-AXIS MIN VALUE* softkey defines the lower limit of the displayed probability range.

As the y-axis scaling has a logarithmic axis the distance between max and min value must be at least one decade. Valid values are in the range $0 < \text{value} < 1$.

Remote command: `CALC:STAT:SCAL:Y:LOW <value>`

ADJUST SETTINGS The *ADJUST SETTINGS* softkey optimizes the level settings of the R&S ESCI according to the measured peak power in order to gain maximum sensitivity of the instrument.

The level range is adjusted according to the measured difference between peak and minimum power for APD measurement and peak and mean power for CCDF measurement in order to obtain maximum power resolution.

Additionally the probability scale is adapted to the selected number of samples.

Remote command: `CALC:STAT:SCAL:AUTO ONCE`

DEFAULT SETTINGS The *DEFAULT SETTINGS* softkey resets the x- and y-axis scalings to their PRE-SET values.

- x-axis ref level: -20 dBm
- x-axis range APD: 100 dB
- x-axis range CCDF: 20 dB
- y-axis upper limit: 1.0
- y-axis lower limit: 1E-6

Remote command: `CALC:STAT:PRES`

MEAN PWR POSITION Defines the relative X position of the mean power value for the CCDF measurement. The default position is 0% (left corner of the grid). This softkey is available if the CCDF measurement is switched on.

Remote command: `CALC:STAT:SCAL:X:MPOS <numeric_value>`

ADJUST SETTINGS see [“ADJUST SETTINGS” on page 4.174](#)

CONT MEAS The *CONT MEAS* softkey starts collecting a new sequence of sample data and calculating the APD or CCDF curve depending on the selected measurement. The next measurement is started automatically as soon as the indicated number of samples has been reached.

Remote command: INIT:CONT ON;
 INIT:IMM

SINGLE MEAS The *SINGLE MEAS* softkey starts collecting a new sequence of sample data and calculating the APD or CCDF curve depending on the selected measurement. At the beginning of the measurement previously obtained measurement results are discarded.

Remote command: INIT:CONT OFF;
 INIT:IMM

Hint for usage of the marker functions with measurement of signal statistics

With the signal statistic measurement level always is displayed on x-axis. Y-axis always is a normalized value between 0 and 1. In contrary to use of marker in frequency or time domain marker is input in level values and the output is in percentage values.

Example

Measurement of CCDF of a IS95 BTS signal, level 0 dBm, frequency 800 MHz

[PRESET]	Switch on preset settings.
[FREQ: CENTER: 800 MHz]	Set center frequency to 800 MHz.
[AMPT: 10 dBm]	Set reference level to 10 dBm.
[BW: 3 MHz]	Set resolution bandwidth to 3 MHz (resolution bandwidth shall be wider then signal bandwidth (1.25 MHz) in order to have the complete signal within the resolution bandwidth).
[MEAS]	Call the menu for measurement functions.
[SIGNAL STATISTIC]	Call the menu for signal statistics measurement.
[CCDF ON/OFF]	Switch on measurement of the complementary cumulative distribution function. The R&S ESCI switches to zero span mode. The power of the signal and the CCDF is calculated for the number of samples selected. With the CCDF function sample detector and video bandwidth are set automatically.
[NO OF SAMPLES: 10000]	Set the number of measurement samples to 10000.
[SINGLE MEAS]	Start the measurement sequence. At the end the resulting trace will display the CCDF for the measured 10000 samples.

GATED TRIGGER Statistic measurements on pulsed signals can be done using the *GATED TRIGGER* softkey. An external frame trigger is required as a time (frame) reference.

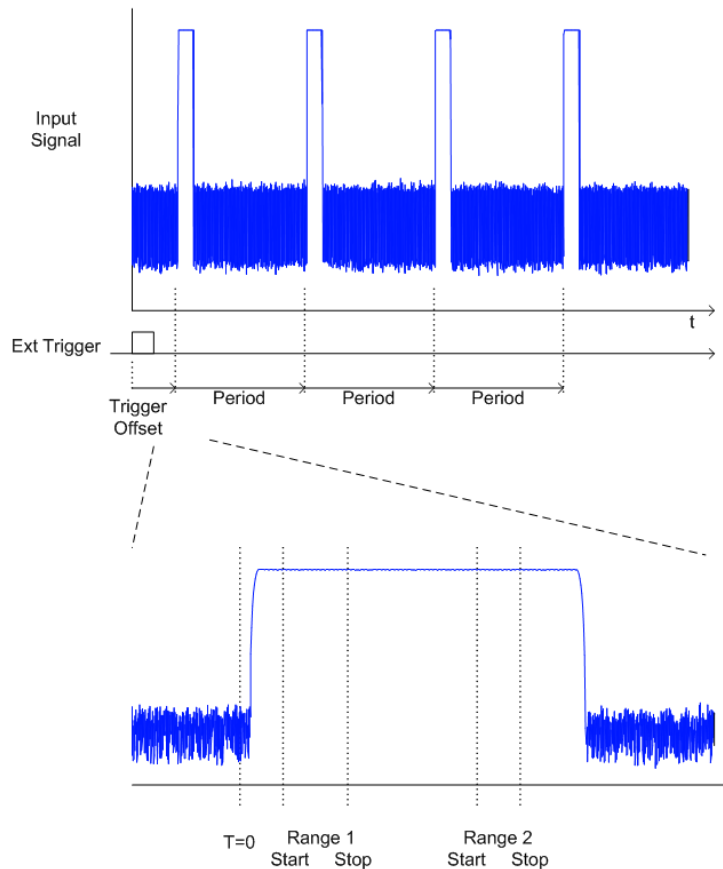

The gate ranges define the part of the I/Q capture data taken into account for the statistics calculation.

These ranges are defined relative to a reference point $T=0$. The gate interval is repeated every period time until the end of the I/Q capture buffer.

The reference point $T=0$ is defined by the external trigger event and the instrument's trigger offset.

GATED TRIGGER activates the gating for statistics functions. The trigger source is changed to EXTERN if this function is switched on.



The I/Q data capturing is repeated until the configured number of valid samples is reached. If the active gate period is outside the I/Q capture buffer or the resulting gate time is zero the measurement will not reach its end. In this case, the range start and stop values have to be checked.

Remote command: SWE:EGAT ON

GATE RANGES The *GATED RANGES* softkey opens a table to configure up to 3 gate ranges for each trace.

GATE RANGES			
	Trace 1	Trace 2	Trace 3
Comment			
Period	4.615 ms		
Range 1 Start	0 us		
Stop	200 us		
Use Range	YES		
Range 2 Start			
Stop			
Use Range			
Range 3 Start			
Stop			
Use Range			

Comment	Comment string
Period	Period of the signal to be measured
Range x Start	Begin of time period to be taken into account
Range x Stop	End of time period to be taken into account
Use Range	YES / NO: Allows to temporarily disable a range



The timing values have full numerical resolution and are only rounded for display.

Remote command:

```

SWE:EGAT:TRACE<1..3>:COMM
SWE:EGAT:TRACE<1..3>:STAT<1..3> ON
SWE:EGAT:TRACE<1..3>:STAR<1..3> <value>
SWE:EGAT:TRACE<1..3>:STOP<1..3> <value>
SWE:EGAT:TRACE<1..3>:PER <value>

```

Gated statistics configuration example:

A statistics evaluation has to be done over the useful part of the signal between t_3 and t_4 . The period of the GSM signal is 4.61536 ms

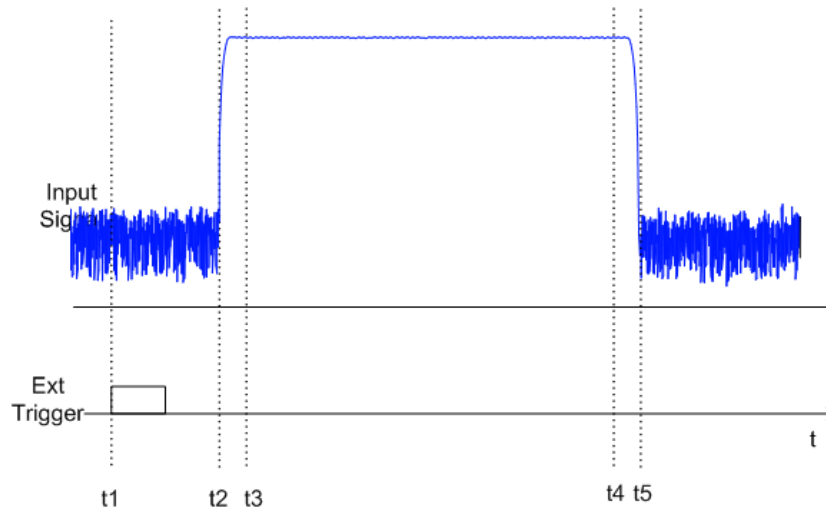

- t_1 External positive trigger slope
- t_2 Begin of burst (after 25 μs)
- t_3 Begin of useful part, to be used for statistics (after 40 μs)
- t_4 End of useful part, to be used for statistics (after 578 μs)
- t_5 End of burst (after 602 μs)

The instrument has to be configured as follows:

- Trigger Offset $t_2 - t_1 = 25 \mu\text{s}$ now the gate ranges are relative to t_2
- Range 1 Start $t_3 - t_2 = 15 \mu\text{s}$ start of range 1 relative to t_2
- Range 1 End $t_4 - t_2 = 553 \mu\text{s}$ end of range 1 relative to t_2

4.6.13.5 Measurement of Carrier/Noise Ratio C/N and C/No

Using the carrier/noise measurement function, the R&S ESCI determines the C/N ratio which can also be shown normalized to a 1 Hz bandwidth (function C/No).

To determine the noise power, a channel at the set center frequency is examined. The bandwidth of the channel is fixed by means of the *CHANNEL BANDWIDTH* function.

The largest signal in the frequency span is the carrier. It is searched when the function is activated and is marked by means of the *REFERENCE FIXED* marker. The noise power of the channel is subtracted from the signal level obtained (C/N), and in the case of a C/No measurement it is referred to a 1 Hz bandwidth.

There are two methods for measuring the carrier/noise ratio:

1. The carrier is outside the channel examined:

In this case, it is sufficient to switch on the desired measurement function and to set the channel bandwidth. The carrier/noise ratio is displayed on the screen.

2. The carrier is inside the channel examined:

In this case, the measurement must be performed in two steps. First, the reference measurement is performed with the carrier being active. This is done by switching on either the C/N or the C/No measurement and waiting for the end of the next measurement run. Then, the carrier is switched off so that only the noise of the test setup is active in the channel. The carrier/noise ratio is displayed after the subsequent measurement has been completed.

The *ADJUST SETTINGS* function facilitates the selection of the frequency span appropriate for the channel bandwidth: it automatically sets the *SPAN* to approx. 4 × channel bandwidth.

The RMS detector is enabled when the power measurement is switched on (*TRACE-DETECTOR-RMS*).

C/N /
C/NO

The C/N C/NO softkey opens the submenu for configuring the carrier/noise ratio measurement.

C/N / C/NO
CHANNEL BANDWIDTH
ADJUST SETTINGS

The user can choose between measurement without (C/N) and measurement with reference to the bandwidth (C/No). In addition, it is possible to select the bandwidth of the channel and to adapt the span.



The measurements are only available in the frequency domain (span >0).

C/N /
C/NO

The C/N and C/NO softkeys enable and disable the measurement of the carrier/noise ratio, the C/No measurement also being referred to a 1 Hz bandwidth.

The maximum value of the current trace is determined when the function is activated and is marked by means of the *REFERENCE FIXED* marker.



The measurement is performed on the trace where MARKER 1 is located. To measure another trace, MARKER 1 has to be shifted to the trace in question using the *SELECT TRACE* softkey in the *MARKER* menu.

If no marker is active, MARKER 1 is activated when the function is switched on.

Remote command:

```
CALC:MARK:FUNC:POW:SEL CN
CALC:MARK:FUNC:POW:RES? CN
CALC:MARK:FUNC:POW:SEL CN0
CALC:MARK:FUNC:POW:RES? CN0
CALC:MARK:FUNC:POW OFF
```

CHANNEL
BANDWIDTH

The *CHANNEL BANDWIDTH* softkey opens a window for selecting the measurement channel bandwidth.

The default setting is 14 kHz.

The specified channel bandwidth allows the optimal setting of the measurement parameters of the R&S ESCI using *ADJUST SETTINGS*.

Remote command: `SENS:POW:ACH:BWID 14kHz`

ADJUST SETTINGS

The *ADJUST SETTINGS* softkey adapts the span to the channel bandwidth selected.

For the carrier/noise ratio measurement, the span is set to:

$4 \times \text{channel bandwidth} + \text{measurement margin}$

The adjustment is performed once; if necessary, the setting can be changed later on.

Remote command: `SENS:POW:ACH:PRES CN | CN0`

4.6.13.6 Measurement of the AM Modulation Depth

MODULATION DEPTH

The *MODULATION DEPTH* softkey switches on the measurement of the AM modulation depth. An AM-modulated carrier is required on the screen for ensuring correct operation.

The level value of *MARKER 1* is taken as the carrier level. When this function is activated, *MARKER 2* and *MARKER 3* are automatically set symmetrically to the carrier on the adjacent peak values of the trace as delta markers and *MARKER 2* is activated for the entry.

When the position of *MARKER 2* (delta) is changed, *MARKER 3* (delta) is moved symmetrically with respect to the reference marker (*MARKER 1*).

If the data entry is activated for *MARKER 3* (*MARKER 1 2 3 4* softkey), the latter can be moved for fine adjustment irrespective of *MARKER 2*.

The R&S ESCI calculates the power at the marker positions from the measured levels. The AM modulation depth is calculated from the ratio between the power values at the reference marker and at the delta markers. When the powers of the two AM side bands are unequal, the mean value of the two power values is used for AM modulation depth calculation.

Measurement example

The AM modulation depth of a carrier modulated with 1 kHz is to be measured at 100 MHz.

[PRESET]	The R&S ESCI is set to the default setting.
[CENTER: 100 MHz]	The center frequency is set to 100 MHz.
[SPAN: 5 kHz]	The span is set to 5 kHz.
[AMPT: 0 dBm]	The reference level is set to 0 dBm.
[MKR FCTN]	MARKER 1 is switched on and positioned at the maximum of the displayed trace.
[MODULATION DEPTH: 1 kHz]	The measurement of the AM modulation depth is switched on. MARKERS 2 and 3 (delta markers) are set to the adjacent peak values of the trace and are activated for the frequency entry.

The AM modulation depth is output in % in the marker info field.

When 1 kHz is entered, MARKER 2 can be exactly positioned on 1 kHz and MARKER 3 at -1 kHz from the reference marker.

Remote command: `CALC:MARK:FUNC:MDEP ON;`
 `CALC:MARK:FUNC:MDEP:RES?`

4.6.13.7 Measurement of the Third Order Intercept (TOI)

If several signals are applied to a transmission two port device with nonlinear characteristic, intermodulation products appear at its output by the sums and differences of the signals. The nonlinear characteristic produces harmonics of the useful signals which intermodulate at the characteristic. The intermodulation products of lower order have a special effect since their level is largest and they are near the useful signals. The intermodulation product of third order causes the highest interference. It is the intermodulation product generated from one of the useful signals and the 2nd harmonic of the second useful signal in case of two-tone modulation.

The frequencies of the intermodulation products are above and below the useful signals. Fig. 4.14 [Intermodulation products \$P_{U1}\$ and \$P_{U2}\$](#) shows intermodulation products P_{I1} and P_{I2} generated by the two useful signals P_{U1} and P_{U2} .

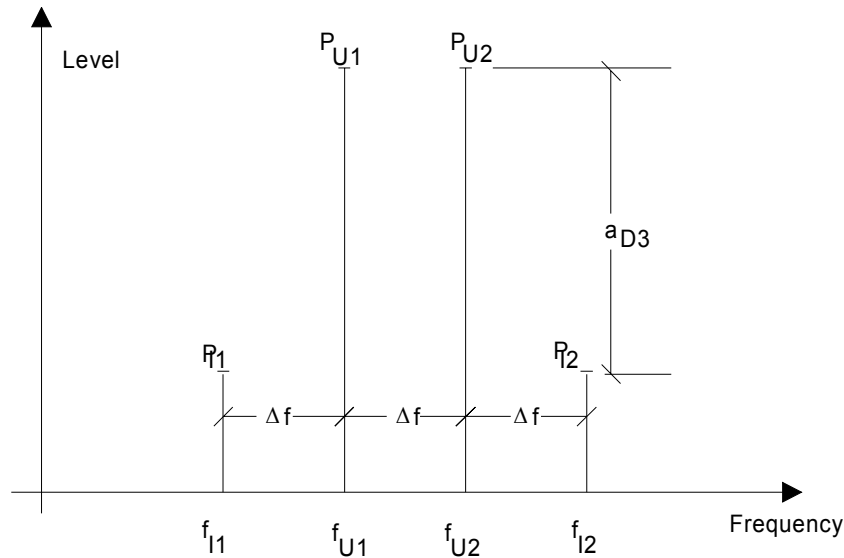

Fig. 4.14 Intermodulation products P_{U1} and P_{U2}

The intermodulation product at f_{I2} is generated by mixing the 2nd harmonic of useful signal P_{U2} and signal P_{U1} , the intermodulation product at f_{I1} by mixing the 2nd harmonic of useful signal P_{U1} and signal P_{U2} .

$$f_{I1} = 2 \times f_{U1} - f_{U2} \tag{22}$$

$$f_{I2} = 2 \times f_{U2} - f_{U1} \tag{23}$$

The level of the intermodulation products depends on the level of the useful signals. If the two useful signals are increased by 1 dB, the level of the intermodulation products increases by 3 dB, which means that spacing a_{D3} between intermodulation signals and useful signals is reduced by 2 dB. This is illustrated in [Fig. 4.15 Dependence of intermodulation level on useful signal level](#).

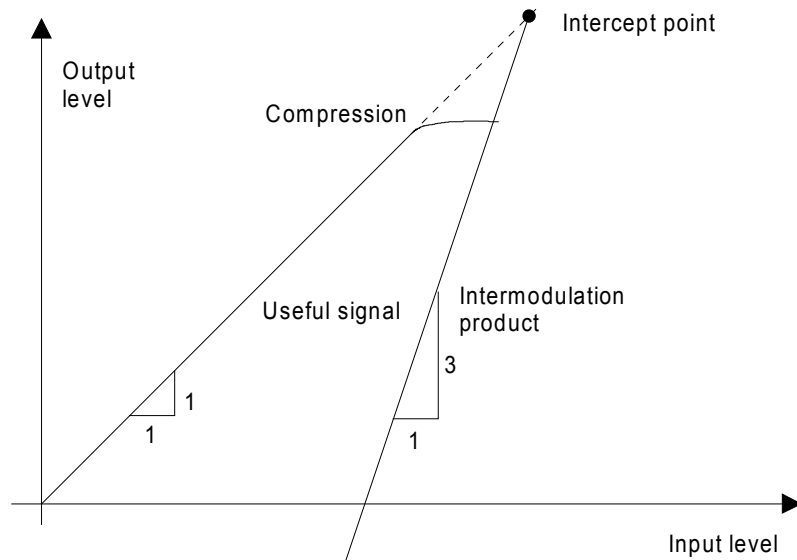

Fig. 4.15 Dependence of intermodulation level on useful signal level

The useful signals at the two port output increase proportionally with the input level as long as the two port is in the linear range. A level change of 1 dB at the input causes a level change of 1 dB at the output. Beyond a certain input level, the two port goes into compression and the output level stops increasing. The intermodulation products of the third order increase three times as much as the useful signals.

The intercept point is the fictitious level where the two lines intersect. It cannot be measured directly since the useful level is previously limited by the maximum two port output power.

It can be calculated from the known line slopes and the measured spacing a_{D3} at a given level according to the following formula.

$$IP3 = \frac{a_{D3}}{2} + P_N \quad (24)$$

The 3rd order intercept point (TOI), for example, is calculated for an intermodulation of 60 dB and an input level PU of -20 dBm according to the following formula:

$$IP3 - \frac{60}{2} + (-20\text{dBm}) - 10\text{dBm} \quad (25)$$

TOI

The *TOI* softkey enables the measurement of the 3rd order intercept point.

A two-tone signal with equal carrier levels is expected at the R&S ESCI input. MARKER 1 and MARKER 2 (both normal markers) are set to the maximum of the two signals. MARKER 3 and MARKER 4 (both delta markers) are placed on the intermodulation products. When the function is enabled, the frequency entry is activated for the delta markers. They can be set manually.

The R&S ESCI calculates the third order intercept from the level spacing between normal markers and delta markers and outputs it in the marker info field.

Remote command: `CALC:MARK:FUNC:TOI ON;`
 `CALC:MARK:FUNC:TOI:RES?`

Example

A two-tone signal with frequencies of 100 MHz and 101 MHz is applied to the RF input of the R&S ESCI. The level of the two signals is -10 dBm.

[PRESET]	The R&S ESCI is set to the default setting.
[CENTER: 100.5 MHz]	The center frequency is set to 100.5 MHz.
[SPAN: 3 MHz]	The span is set to 3 MHz.
[AMPT: -10 dBm]	The reference level is set to -10 dBm.
[MKR FCTN]	MARKER 1 is switched on and set to the signal peak.
[TOI]	The R&S ESCI sets the 4 markers to the useful signals and the intermodulation products and calculates the third order intercept. The result is output in the marker info field.

SELECT MARKER

The *SELECT MARKER* softkey activates the selection of a marker for functions *MODULATION DEPTH* and *TOI*. Thus, the markers can be fine-adjusted for these functions.

The markers are numerically selected in a data entry field. Delta marker 1 is selected by entering '0'.

If the marker is in the switch-off state, it will be switched on and can thus be shifted.

Remote command: `CALC:MARK1 ON;`
 `CALC:MARK1:X <value>;`
 `CALC:MARK1:Y?`

**TOI MKR CALC
SRCH**

The TOI measurement is based on positioning the markers 3 and 4 onto the position of the calculated intermodulation products. The accuracy of these frequency calculations depend on the precision of the two carrier frequencies found with peak search. The softkey *TOI MKR CALC SRCH* allows to switch between the calculated marker position (CALC) and performing a local peak search near the expected frequencies (SRCH) instead of the faster position calculation.

By default, the faster CALC method is used.

Remote command: `CALC:MARK:FUNC:TOI:MARK CALC`

4.6.13.8 Harmonic Measurement**HARMONIC
DISTOR**

HARMONIC ON OFF
NO. OF HARMONICS
HARMONIC SWEPTIME
HARMONIC RBW AUTO
ADJUST SETTINGS

The *HARMONIC DISTOR* softkey opens this submenu and activates the harmonic distortion measurement.

In the upper screen the zero span sweeps on all harmonics are shown, separated by a grid line. This allows a very good overview about the measurement. In the lower screen the mean RMS results are displayed in numerical values and the THD values can be seen in the marker info field.

The resolution bandwidth will be automatically adjusted: $RBW_n = RBW_1 * n$, if that RBW is not available the next higher value is used.

The results can be obtained via the following remote commands:

Trace read out via the normal trace subsystem. The first harmonic frequency can be read out via the center frequency command.

THD value comma separated in % and dB:

Remote command: `CALC:MARK:FUNC:HARM:DIST? TOT`

Comma separated list of harmonic levels, for each harmonic one value:

Remote command: `CALC:MARK:FUNC:HARM:LIST?`

**HARMONIC
ON | OFF**

The *HARMONIC ON/OFF* softkey activates the harmonic distortion measurement. With this measurement it is possible to measure easily the harmonics e.g. from a VCO. In addition the THD (total harmonic distortion) is calculated in % and dB.

There are 2 possible modes within the harmonic measurement. When entering the harmonic measurement from a frequency sweep (span > 0 Hz) an automatic search for the first harmonic is carried out within that given frequency range. Also a level adjust will be carried out. Is the zero span mode active before entering the harmonic measurement, the center frequency is unchanged.

Remote command: `CALC:MARK:FUNC:HARM:STAT ON | OFF`

The results can be obtained via the following remote commands:

Trace read out via the normal trace subsystem. The first harmonic frequency can be read out via the center frequency command.

THD value comma separated in % and dB:

Remote command: `CALC:MARK:FUNC:HARM:DIST? TOT`

Comma separated list of harmonic levels, for each harmonic one value:

Remote command: `CALC:MARK:FUNC:HARM:LIST?`

NO. OF HARMONICS With the softkey *NO. OF HARMONICS* the number of harmonics which shall be measured can be adjusted. The range is from 1 to 26.

Remote command: `CALC:MARK:FUNC:HARM:NHAR <numerical value>`

HARMONIC SWEPTIME The *HARMONIC SWEPTIME* softkey allows to set the value how long the zero span measurement on each harmonic frequency shall take place. This is an alias softkey to the normal sweep time of the zero span, therefore the same parser command is to be used.

HARMONIC RBW AUTO The softkey *HARMONIC RBW AUTO* disables the resolution bandwidth.

Remote command: `CALC:MARK:FUNC:HARM:BAND:AUTO ON | OFF`

ADJUST SETTINGS The *ADJUST SETTINGS* softkey activates the frequency search in the frequency range from before starting the harmonic measurement (if harmonic measurement was started from frequency sweep) and the level adjust.

Remote command: `CALC:MARK:FUNC:HARM:PRES`

4.6.13.9 Measuring Spurious Emissions

All real amplifiers also generate unwanted RF products outside the assigned frequency band. These spurious emissions are usually measured across a wide frequency range, for example from 9 kHz to 7 GHz. The analyzer settings are specified for each frequency range.

SPURIOUS EMISSIONS

SPURIOUS ON OFF	
SWEEP LIST ↓	EDIT SWEEP LIST
	INS BEFORE RANGE
	INS AFTER RANGE
	DELETE RANGE
	NEXT RANGES
	PREVIOUS RANGES
	ADJUST AXIS
	START MEAS
	STOP MEAS
LIST EVALUATION	
PAGE UP / PAGE DOWN	
START MEAS	
STOP MEAS	
Side menu	
PEAK SEARCH	
PEAKS PER RANGE	
MARGIN	
VIEW PEAK LIST ↓	SORT BY FREQUENCY
	SORT BY DELTA LIM
	ASCII FILE EXPORT
	DECIM SEP
	PAGE UP / PAGE DOWN

In the Spurious Emissions measurement mode, the R&S ESCI performs measurements in predefined frequency ranges with settings that can be specified individually for each of these ranges.

For this purpose, the SWEEP TABLE settings or the current device settings are used. Up to 20 subranges can be defined (they need not directly follow one another) across which the R&S ESCI sweeps in subsequent order. However, the measurement ranges must not overlap. The measurement parameters can be selected independently from each other in every subrange (*SWEEP LIST* menu, *EDIT SWEEP LIST*).

Limit lines are defined and displayed irrespective of the sweep ranges, i.e. they are not part of the sweep ranges. The unit of the limit lines is restricted to dB or dBm.

The frequency range where measurements are actually performed is set by the start and stop frequency parameters of the R&S ESCI; these parameters are independent of the sweep ranges. It is thus possible to define sweep ranges for a measurement task that can be stored and reloaded and to quickly and easily set the frequency range to be actually measured by means of two parameters; complex editing in the sweep table is not necessary.



When a limit line is defined in steps, the weaker limit is used at the frequency point with the straight vertical section.

SPURIOUS ON | OFF The *SPURIOUS ON/OFF* softkey switches the spurious emissions measurement on or off according to the current configuration.

Remote command: `SWEEP:MODE LIST` switches the spurious list on
 `SWEEP:MODE AUTO` switches the spurious list off

SWEEP LIST The *SWEEP LIST* softkey opens a submenu where predefined sweep ranges can be edited, or new ranges generated or deleted. A table listing the current sweep ranges is displayed.

Remote command: --

EDIT SWEEP LIST The *EDIT SWEEP LIST* softkey opens the table for editing the sweep ranges.

SWEEP LIST					
	RANGE 1	RANGE 2	RANGE 3	RANGE 4	RANGE 5
Range Start	9 kHz	150 MHz	30 MHz		
Range Stop	150 kHz	30 MHz	1 GHz		
Filter Type	NORMAL (3dB)	NORMAL (3dB)	NORMAL (3dB)		
RBW	1 kHz	10 kHz	100 kHz		
VBW	3 kHz	30 kHz	300 MHz		
Sweep time mode	AUTO	AUTO	AUTO		
Sweep time	145 ms	300 ms	100 ms		
Detector	RMS	RMS	RMS		
REF-Level	-10 dBm	-10 dBm	-10 dBm		
RF-Att. mode	AUTO	AUTO	AUTO		
RF-Attenuator	20 dB	20 dB	20 dB		
PRE-AMP	OFF	OFF	OFF		
Sweep Points	501	4001	8001		
Stop after sweep	OFF	OFF	OFF		
Transd. factor	<NONE>	<NONE>	<NONE>		
Limit check	ON	ON	ON		
Limit	-13 dBm	-13 dBm	-13 dBm		

In the *SWEEP LIST* table, the individual sweep ranges are set.

Range Start:	Start frequency of the range
Range Stop:	Stop frequency of the range
Filter Type:	NORMAL (3dB), EMI (6dB), CHANNEL, RRC
RBW:	Resolution filter bandwidth
VBW:	Video filter bandwidth
VBW:	Video filter bandwidth; not applicable for CHANNEL and RRC filters
Sweep Time Mode:	AUTO, MANUAL
Sweep Time:	Sweep time; if <i>AUTO</i> is indicated for the sweep time mode, the automatically calculated sweep time is displayed. If the cell is edited, the associated sweep time mode is automatically set to <i>MANUAL</i> .
Detector:	Specifies the range detector: AUTO PEAK, MAX PEAK, MIN PEAK, SAMPLE, RMS, AVERAGE
REF-Level:	Reference level in dBm The upper edge of the displayed screen area is the value of the maximum reference level, corrected by the associated transducer factor.
RF-Attenuator-Mode:	AUTO, MANUAL
RF-Attenuator:	Number; as with Sweep Time
PRE-AMP:	ON, OFF preamplifier selection (options B23, B25, if available)
Sweep Points:	Number of sweep points per range (sweep segment). The maximum number of sweep points is 8001.
Stop after Sweep:	ON, OFF if <i>ON</i> , the sweep is stopped after the range and continued only if confirmed by you via a message box (bit 10 of the " STATUS: OPERATION Register " on page 5.24).
Transd. factor:	NONE or factor (enter via selection list)
Limit check:	ON, OFF (common for all ranges)
Limit:	Limit in dBm (enter via selection list) A temporary limit line <i>_SPUL_IN_</i> is used, based on the range limits. This temporary limit line is created at measurement start and may be copied for other purposes.

Remote command: SENS:LIST:RANG<1...20>:...

INS BEFORE RANGE The *INS BEFORE RANGE* softkey inserts a range in front of the marked line.

Remote command: --

INS AFTER RANGE The *INS AFTER RANGE* softkey inserts a range following the marked line.

Remote command: --

DELETE RANGE	<p>The <i>DELETE RANGE</i> softkey deletes the current range. All higher ranges are set back by one.</p> <p>Remote command: LIST:RANGe<1...20>:DELeTe</p>
NEXT RANGES	<p>The <i>NEXT RANGES</i> softkey activates the displays of the next higher subranges, i.e. 6 to 10, 11 to 15 or 16 to 20.</p> <p>Remote command: --</p>
PREVIOUS RANGES	<p>The <i>PREVIOUS RANGES</i> softkey activates the displays of the next lower subranges, i.e. 1 to 5, 6 to 10 or 11 to 15.</p> <p>Remote command: --</p>
ADJUST AXIS	<p>The <i>ADJUST AXIS</i> softkey automatically adjusts the frequency axis of measurement diagram so that the start frequency matches the start frequency of the first sweep range, and the stop frequency of the last sweep range.</p> <p>Remote command: -- (via FREQuency:START <num_value> / FREQuency:STOP <num_value>)</p>
START MEAS	<p>Using the <i>START MEAS</i> softkey, you can start the measurement while the submenu is simultaneously exited.</p> <p>When the measurement is started, the R&S ESCI sets up the measurement diagram in the selected measurement window and starts the measurement in the selected mode.</p> <p>With <i>SINGLE</i>, a single frequency sweep occurs; afterwards the R&S ESCI remains on the stop frequency.</p> <p>With <i>CONTINUOUS</i>, the measurement continues until it is stopped.</p> <p>You can stop the measurement with <i>STOP SWEEP</i>.</p> <p>If a <i>STOP AFTER SWEEP</i> point has been defined in the range, the sweep stops automatically at the end of the respective range to allow you to change the external circuitry, for example. This is indicated in a message box:</p> <p>SWEEP Range# reached CONTINUE/BREAK</p> <p>If <i>CONTINUE</i> is selected, the sweep is continued in the next range. If <i>BREAK</i> is selected, the sweep is stopped.</p> <p>Remote command: INIT:SPUR starts the measurement INIT:CONM starts the measurement after a BREAK has been reached ABORT stops the measurement after a range has been reached</p>
STOP MEAS	<p>The <i>STOP MEAS</i> softkey stops the measurement. The measurement data can be analyzed.</p> <p>Remote command: ABORT</p>

LIST EVALUATION The *LIST EVALUATION* softkey activates or deactivates the spurious emission measurement LIST EVALUATION. The peak search evaluation is automatically done during measurement and the results are displayed in a table in the lower part of the screen.

Following results are listed:

- frequency range
- frequency of the absolute peak power in this range in dBm
- level delta to the limit with margin in dB
- limit check state (by color change and an asterisk at the end of the line if failed)

If *LIST EVALUATION* is switched on, the functions *PEAKS PER RANGE*, *MARGIN*,

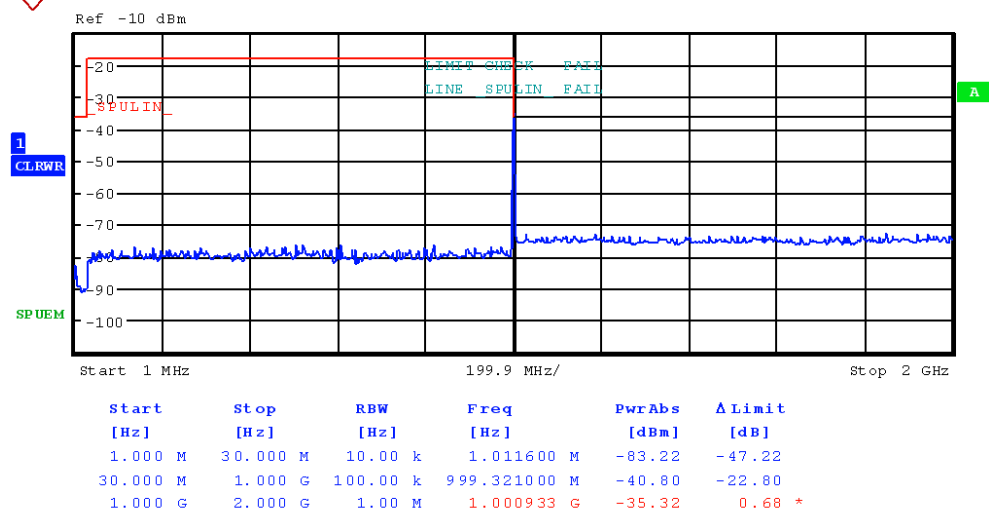

PEAK SEARCH and *VIEW PEAK LIST* are not available.

Remote command: `CALC1:PEAK:AUTO ON | OFF`

STOP MEAS See “STOP MEAS” on page 4.189.

START MEAS See “START MEAS” on page 4.189.

PEAK SEARCH The *PEAK SEARCH* softkey starts the process of determining the list of the sub-range maximums from the existing sweep results. This procedure can be repeated as often as desired, e.g. to experiment with the various threshold settings.

It is activated only after a measurement has been performed with *START MEAS*.

Remote command: `CALC:PEAK`

PEAKS PER RANGE The *PEAKS PER RANGE* softkey activates entry of the number of peaks per range that are stored in the list. The value range extends from 1 to 50. Once the selected number of peaks has been reached, the peak search is stopped in the current range and continued in the next range. The default value is 25.

Remote command: `CALC:PEAK:SUBR 1...50`

MARGIN The *MARGIN* softkey activates entry of the margin, i.e. the acceptance threshold for determining the peak list. The limit line is shifted by this value when the maximums are determined. The value range extends from -200 dB to 200 dB. The default value is 6 dB.

Remote command: `CALC:PEAK:MARG -200dB...200dB`

VIEW PEAK LIST The *VIEW PEAK LIST* softkey opens the submenu for viewing the peak list. It is activated for display only after a *PEAK SEARCH* has been performed with *PEAK SEARCH*.

VIEW PEAK LIST			
TRACE / Detector	FREQUENCY	LEVEL dBm	DELTA LIMIT dB
1 RMS	80.0000 MHz	-36.02	-5.02
1 RMS	80.0001 MHz	-30.07	+0.24
1 RMS	85.1234 MHz	-30.02	-0.02
1 AVERAGE	130.234 MHz	-29.12	-5.12

If no limit check is active, a delta limit of +200dB is listed.

Remote command: `TRACe? SPURious`

SORT BY FREQUENCY The *SORT BY FREQUENCY* softkey sorts the table according to the entries in the *FREQUENCY* column in descending order.

Remote command: `--`

SORT BY DELTA LIM The *SORT BY DELTA LIM* softkey sorts the table according to the entries in the *DELTA LIM* column (default) in descending order. If no limit line has been specified, an offset of 200 dB is assumed for all peaks.

Remote command: `--`

ASCII FILE EXPORT The *ASCII FILE EXPORT* softkey stores the peak list in ASCII format to a file on a memory stick or a floppy disk.

The file has a header containing important parameters for scaling, several data sections containing the sweep settings per range and a data section containing the peak list.

The header data is made up of three columns, separated by ';':

parameter name; numeric value; base unit

Table 4-1 Example: ASCII export table - file header

File contents	Explanation
Type;R&S ESCI;	Model
Version;3.90;	Firmware version
Date;02.Aug 2006;	Storage date of data set
Mode;ANALYZER; SPURIOUS;	Operating mode of the device
Start;9000.000000;Hz Stop;7000000000.000000;Hz	Start/stop of the span Unit: Hz
x-Axis;LIN;	Linear (LIN) or logarithmic (LOG) (future feature) scaling of the x-axis
Sweep Count;1;	Selected number of sweeps

The data section for the measurement values starts with the key word "TRACE <n>:", where <n> includes the number of the used trace. Next comes the peak list with several columns also separated by ';':

Table 4-2 Example: ASCII export table - file data section

File contents	Explanation
TRACE 1:	Selected trace
Trace Mode;CLR/WRITE;	Display mode of trace: CLR/WRITE,AVERAGE,MAX HOLD,MIN HOLD, VIEW, BLANK
x-Unit;Hz;	Unit of x values:
y-Unit;dBm;	Unit of y values:
Margin;6.000000:s	Peak List margin
Values;8;	Number of measurement points
1;1548807257.5999999000;- 65.602280;-5.602280 1;1587207214.4000001000;- 65.327530;-5.327530 1;2112006624.0000000000;- 4.388008;55.611992	Measurement values: <Trace>;<x value>; <y value>;<delta limit>

Spreadsheet programs such as MS Excel can read this format. Use ';' as the delimiter for the table cells.



Different language versions of evaluation programs may require different handling of the decimal point. Using the *DECIM SEP* softkey, you can thus choose between the delimiters '.' (decimal point) and ',' (comma).

Remote command: `M MEM:STOR:SPUR,'F:\TEST.ASC'`

DECIM SEP In the case of floating-point numbers, use the *DECIM SEP* softkey to select between '.' (decimal point) and ',' (comma) as the decimal delimiter for the ASCII FILE EXPORT function.

By selecting the decimal delimiter, various language versions of evaluation programs (e.g. MS Excel) are supported.

Remote command: `FORM:DEXP:DSEP POIN`

PAGE UP / PAGE DOWN Using *PAGE UP* and *PAGE DOWN*, you can scroll forward and backward through the peak list pages.

They are active only as long as a peak list is displayed.

4.6.13.10 Spectrum Emission Mask Measurement

The Spectrum Emission Mask (SEM) measurement defines a measurement that monitors compliance with a spectral mask. The SEM measurement of the base unit allows a flexible definition of all parameters in the SEM measurement. The analyzer performs measurements in predefined frequency ranges with settings that can be specified individually for each of these ranges.

For this purpose, the SWEEP LIST settings or the current instrument settings are used. Up to 20 subranges can be defined (they need not directly follow one another) across which the analyzer sweeps in subsequent order. However, the measurement ranges must not overlap. The measurement parameters can be selected independently from each other in every subrange (SWEEP LIST menu, EDIT SWEEP LIST).

In the Spectrum Emission Mask, as in the Spurious Emissions measurement, a range defines a segment, for which you can define the following parameters separately: start and stop frequency, RBW, VBW, sweep time, reference level, attenuator settings, and limit values. Via the sweep list, you define the ranges and their settings (for details on settings refer to the SWEEP LIST softkey).

The following rules apply to ranges:

- The minimum span of a range is 10 Hz.
- The individual ranges must not overlap (but need not directly follow one another).
- The maximum number of ranges is 20.
- A minimum of three ranges is mandatory.
- The reference range cannot be deleted (it is marked in with "Ref").

The frequency range where measurements are actually performed is set by the start and stop frequency parameters of the analyzer; these parameters are independent of the sweep ranges. It is thus possible to define sweep ranges for a measurement task that can be stored and reloaded and to quickly and easily set the frequency range to be actually measured by means of two parameters; complex editing in the sweep table is not necessary.

Provided XML Files for the Spectrum Emission Mask Measurement

You can change the settings manually or via XML files. The XML files offer a quick way to change the configuration. A set of ready-made XML files for different standards is already provided. For details see Table1: Provided XML files. You can also create and use your own XML files (for details see [“Format Description of Spectrum Emission Mask XML files” on page 4.196](#)). All XML files are stored under D:\r_s\instr\sem_std. Use the LOAD STANDARD softkey for quick access to the available XML files.

Path	XML File Name	Displayed Standard Characteristics*
D:\r_s\instr\sem_std\cdma2000\DL	default0.xml	cdma2000 BC0 DL
	default1.xml	cdma2000 BC1 DL
D:\r_s\instr\sem_std\cdma2000\UL	default0.xml	cdma2000 BC0 UL
	default1.xml	cdma2000 BC1 UL
D:\r_s\instr\sem_std\EUTRA-LTE\DL\CategoryA	BW_01_4_MHz__CFhigher1GHz.xml	LTE Cat A > 1GHz DL
	BW_01_4_MHz__CFlower1GHz.xml	LTE Cat A < 1GHz DL

Path	XML File Name	Displayed Standard Characteristics*
	BW_03_0_MHz__CFhigher1GHz.xml	LTE Cat A > 1GHz DL
	BW_03_0_MHz__CFlower1GHz.xml	LTE Cat A < 1GHz DL
	BW_05_0_MHz__CFhigher1GHz.xml	LTE Cat A > 1GHz DL
	BW_05_0_MHz__CFlower1GHz.xml	LTE Cat A < 1GHz DL
	BW_10_0_MHz__CFhigher1GHz.xml	LTE Cat A > 1GHz DL
	BW_10_0_MHz__CFlower1GHz.xml	LTE Cat A < 1GHz DL
	BW_15_0_MHz__CFhigher1GHz.xml	LTE Cat A > 1GHz DL
	BW_15_0_MHz__CFlower1GHz.xml	LTE Cat A < 1GHz DL
	BW_20_0_MHz__CFhigher1GHz.xml	LTE Cat A > 1GHz DL
	BW_20_0_MHz__CFlower1GHz.xml	LTE Cat A < 1GHz DL
D:\r_s\instr\sem_std\EUTRA-LTE\DL\CategoryB	BW_01_4_MHz__CFhigher1GHz.xml	LTE Cat B > 1GHz DL
	BW_01_4_MHz__CFlower1GHz.xml	LTE Cat B < 1GHz DL
	BW_03_0_MHz__CFhigher1GHz.xml	LTE Cat B > 1GHz DL
	BW_03_0_MHz__CFlower1GHz.xml	LTE Cat B < 1GHz DL
	BW_05_0_MHz__CFhigher1GHz.xml	LTE Cat B > 1GHz DL
	BW_05_0_MHz__CFlower1GHz.xml	LTE Cat B < 1GHz DL
	BW_10_0_MHz__CFhigher1GHz.xml	LTE Cat B > 1GHz DL
	BW_10_0_MHz__CFlower1GHz.xml	LTE Cat B < 1GHz DL
	BW_15_0_MHz__CFhigher1GHz.xml	LTE Cat B > 1GHz DL
	BW_15_0_MHz__CFlower1GHz.xml	LTE Cat B < 1GHz DL
	BW_20_0_MHz__CFhigher1GHz.xml	LTE Cat B > 1GHz DL
	BW_20_0_MHz__CFlower1GHz.xml	LTE Cat B < 1GHz DL
D:\r_s\instr\sem_std\EUTRA-LTE\UL\Standard	BW_05_0_MHz.xml	LTE UL
	BW_10_0_MHz.xml	LTE UL
	BW_15_0_MHz.xml	LTE UL
	BW_20_0_MHz.xml	LTE UL
D:\r_s\instr\sem_std\WCDMA\3GPP\DL	PowerClass_31_39.xml	W-CDMA 3GPP (31,39)dBm DL
	PowerClass_39_43.xml	W-CDMA 3GPP (39,43)dBm DL
	PowerClass_43_INF.xml	W-CDMA 3GPP (43,INF)dBm DL
	PowerClass_negINF_31.xml	W-CDMA 3GPP (-INF,31)dBm DL
D:\r_s\instr\sem_std\WCDMA\3GPP\UL	3GPP_UL.xml	W-CDMA 3GPP_UL
D:\r_s\instr\sem_std\WIBRO\DL	PowerClass_29_40.xml	WiBro TTA (29,40)dBm DL
	PowerClass_40_INF.xml	WiBro TTA (40,INF)dBm DL

Path	XML File Name	Displayed Standard Characteristics*
	PowerClass_negINF_29.xml	WiBro TTA (-INF,29)dBm DL
D:\r_s\instr\sem_std\WIBRO\UL	PowerClass_23_INF.xml	WiBro TTA (23,INF)dBm UL
	PowerClass_negINF_23.xml	WiBro TTA (23,INF)dBm UL
D:\R_S\instr\sem_std\WIMAX\DL\ETSI\...MHz (1.75 MHz, 2.00 MHz, 3.50 MHz, 7.00 MHz, 14.00 MHz, 28.00 MHz)	System_Type_E.xml	WIMAX DL ETSI-System Type E DL
	System_Type_F.xml	WIMAX ETSI-System Type F DL
	System_Type_G.xml	WIMAX ETSI-System Type G DL
D:\R_S\instr\sem_std\WIMAX\DL\IEEE	10MHz.xml	WIMAX 10MHz DL
	20MHz.xml	WIMAX 20MHz DL
D:\R_S\instr\sem_std\WIMAX\UL\ETSI\...MHz (1.75 MHz, 2.00 MHz, 3.50 MHz, 7.00 MHz, 14.00 MHz, 28.00 MHz)	System_Type_E.xml	WIMAX System Type E UL
	System_Type_F.xml	WIMAX System Type F UL
	System_Type_G.xml	WIMAX System Type G UL
D:\R_S\instr\sem_std\WIMAX\UL\IEEE	10MHz.xml	WIMAX 10MHz UL
	20MHz.xml	WIMAX 20MHz UL
D:\R_S\instr\sem_std\WLAN\802_11_TURBO	ETSI.xml	IEEE 802.11
	IEEE.xml	IEEE 802.11
D:\R_S\instr\sem_std\WLAN\802_11a	ETSI.xml	IEEE 802.11a
	IEEE.xml	IEEE 802.11a
D:\R_S\instr\sem_std\WLAN\802_11b	IEEE.xml	IEEE 802.11b
D:\R_S\instr\sem_std\WLAN\802_11j_10MHz	ETSI.xml	IEEE 802.11j
	IEEE.xml	IEEE 802.11j
D:\R_S\instr\sem_std\WLAN\802_11j_20MHz	ETSI.xml	IEEE 802.11j
	IEEE.xml	IEEE 802.11j

*abbreviations:

BC: band class

UL: uplink

DL: downlink

TTA: telecommunications technology association

Format Description of Spectrum Emission Mask XML files

The files for importing range settings are in XML format and therefore obey the rules of the XML standard. Below, the child nodes, attributes, and structure defined for the data import is described. Build your own XML files according to these conventions because the instrument can only interpret XML files of a known structure. For example files look in the *D:\r_slvinst\sem_std* folder.



It is mandatory to follow the structure exactly as shown below or else the analyzer is not able to interpret the XML file and error messages are shown on the screen. For this reason is it recommended to make a copy of an existing file and edit the copy of the file. The default files can be found in the *D:\r_slvinst\sem_std* folder.

Basically, the file consists of three elements that can be defined.

- The first element of the structure is the BaseFormat element. It carries information about basic settings. In this element only the ReferencePower child node has any effects on the measurement itself. The other attributes and child nodes are used to display information about the Spectrum Emission Mask Standard on the measurement screen. The child nodes and attributes of this element are shown in [Table 4-3](#).

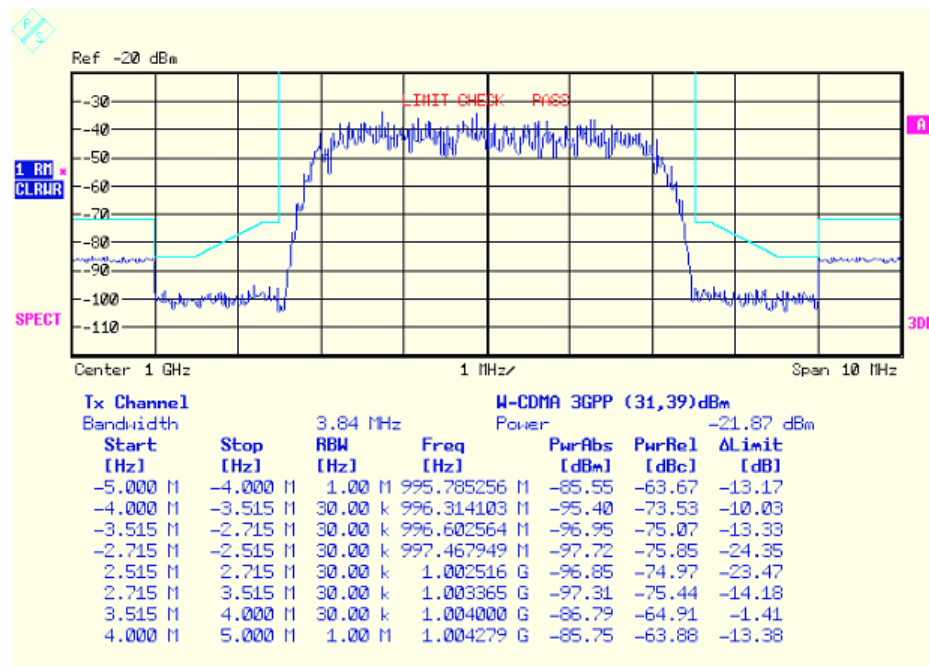

In the example above (*PowerClass_31_39.xml* under *D:\r_slvinst\sem_std\WCDMA\3GPP*), these attributes are defined as follows:

```
Standard="W-CDMA 3GPP"
LinkDirection="DL"
PowerClass="(31,39)dBm"
```

- The second element is the PowerClass element, which is embedded in the BaseFormat element. It carries settings information about the power classes. The child nodes and attributes of this element are shown in [Table 4-4](#).

- The third element is the Range element, which in turn is embedded in the PowerClass element. It carries the settings information of the range. There have to be at least three defined ranges: one reference range and at least one range to either side of the reference range. The maximum number of ranges is twenty.

Note that there are two Limit nodes to be defined: one that gives the limit in absolute values and one in relative values. Make sure units for the Start and Stop nodes are identical for each Limit node. For details refer to the SWEEP LIST softkey and the corresponding parameter description. The child nodes and attributes of this element are shown in [Table 4-5](#).

The following tables show the child nodes and attributes of each element and show if a child node or attribute is mandatory for the analyzer to interpret the file or not. Since the hierarchy of the XML can not be seen in the tables, either view one of the default files already stored on the analyzer in the *D:\r_sl\instr\sem_std* directory or check the structure as shown below.

Below, a basic example of the structure of the file is shown, containing all mandatory attributes and child nodes. Note that the PowerClass element and the range element are themselves elements of the Base Format element and are to be inserted where noted. The separation is done here simply for reasons of a better overview. Also, no example values are given here to allow a quick reference to the tables above. Italic font shows the placeholders for the values.

- The Base Format element is structured as follows:

```
<RS_SEM_ACP_FileFormat Version="1.0.0.0" Date="2008-02-28T15:21:39Z">
  <Name>Standard</Name>
  <Instrument>
    <Type>Instrument Type</Type>
    <Application>Application</Application>
  </Instrument>
  <LinkDirection Name="Name">
    <ReferencePower>
      <Method>Method</Method>
    </ReferencePower>
    <PowerClass Index="n">
      <!-- For contents of the PowerClass node see Table 4-4 -->
      <!-- Define up to four PowerClass nodes -->
    </PowerClass>
  </LinkDirection>
</RS_SEM_ACP_File>
```

- The PowerClass element is structured as follows:

```
<PowerClass Index="n">
  <StartPower Unit="dBm" InclusiveFlag="true" Value="StartPowerValue"/>
  <StopPower Unit="dBm" InclusiveFlag="false" Value="StopPowerValue"/>
  <DefaultLimitFailMode>Limit Fail Mode</DefaultLimitFailMode>
  <Range Index="n">
    <!-- For contents of the Range node see Table 4-5 -->
    <!-- Define up to twenty Range nodes -->
  </Range>
  ...
</PowerClass>
```

- The Range element is structured as follows:

```
<Range Index="n">
  <Name="Name">
    <ChannelType>Channel Type</Channel Type>
    <WeightingFilter>
      <Type>FilterType</Type>
      <RollOffFactor>Factor</RollOffFactor>
      <Bandwidth>Bandwidth</Bandwidth>
    </WeightingFilter>
    <FrequencyRange>
      <Start>RangeStart</Start>
      <Stop>RangeStop</Stop>
    </FrequencyRange>
    <Limit>
      <Start Unit="Unit" Value="Value"/>
      <Stop Unit="Unit" Value="Value"/>
    </Limit>
    <Limit>
      <Start Unit="Unit" Value="Value"/>
      <Stop Unit="Unit" Value="Value"/>
    </Limit>
    <RBW Bandwidth="Bandwidth" Type="FilterType"/>
    <VBW Bandwidth="Bandwidth"/>
    <Detector>Detector</Detector>
    <Sweep Mode="SweepMode" Time="SweepTime"/>
```

```

<Amplitude>
  <ReferenceLevel Unit="dBm" Value="Value"/>
  <RFAttenuation Mode="Auto" Unit="dB" Value="Value"/>
  <Preamplifier State="State"/>
</Amplitude>
</Range>

```

Table 4-3 Attributes and child nodes of the BaseFormat element

Child Node	Attribute	Value	Parameter Description	Mandatory
	FileFormatVersion	1.0.0.0		Yes
	Date	"YYYY-MM-DD HH:MM:SS"	Date in ISO 8601 format	No
Name		<string>	Name of the standard	Yes
Instrument	Type	FSP	Name of the instrument	No
	Application	SA	Name of the application	No
LinkDirection	Name	Downlink Uplink None		Yes
	ShortName	DL UL		No
ReferencePower				Yes
Method	TX Channel Power TX Channel Peak Power			Yes
ReferenceChannel	<string>			No

Table 4-4 Attributes and child nodes of the PowerClass element

Child Node	Attribute	Value	Parameter Description	Mandatory
	Index	0	Only index 0 is currently supported, others are ignored	Yes
StartPower	Value	<power in dBm>	Start power must equal the stop power of the previous power class. The StartPower value of the first range is -200	Yes
	Unit	dBm		Yes
	InclusiveFlag	"true"		Yes
StopPower	Value	<power in dBm>	Stop power must equal the start power of the next power class. The StopPower value of the last range is 200	Yes
	Unit	dBm		Yes
	InclusiveFlag	"false"		Yes
DefaultLimitFailMode		Absolute Relative Absolute and Relative Absolute or Relative		Yes

Table 4-5 Attributes and child nodes of the Range element (normal ranges)

Child Node	Attribute	Value	Parameter Description	Mandatory
	Index	0...19	Indexes are continuous and have to start with 0	Yes
	Name	<string>	Name of the range	Only if ReferenceChannel contains a name and range is reference range
	ShortName	<string>	Short name of the range	No
ChannelType		TX Adjacent		Yes
WeightingFilter				Only if ReferencePower method is "TX Channel Power" and the range is the reference range"
Type		RRC CFILTer	Type of weighting filter	Yes
RollOfffactor		0...1	Excess filter bandwidth	Only if filter type is RRC
Bandwidth		<bandwidth in Hz>	Filter bandwidth	Only if filter type is RRC
FrequencyRange				Yes
Start		<frequency in Hz>	Start value of the range	Yes
Stop		<frequency in Hz>	Stop value of the range	Yes
Limit			A Range must contain exactly two limit nodes; one of the limit nodes has to have a relative unit (e.g. dBc), the other one must have an absolute unit (e.g. dBm)	Yes
Start	Value	<numeric value>	Power limit at start frequency	Yes
	Unit	dBm/Hz dBm dBc dBr dB	Sets the unit of start frequency	Yes
Stop	Value	<numeric value>	Power limit at stop frequency	Yes
	Unit	dBm/Hz dBm dBc dBr dB	Sets the unit of stop frequency	Yes
LimitFailMode		Absolute Relative Absolute and Relative Absolute or Relative		No (if specified, it has to be equal to Default-LimitFailMode)
RBW	Bandwidth	<bandwidth in Hz>		Yes
	Type	NORM PULS CFIL RRC		No
VBW	Bandwidth	<bandwidth in Hz>		Yes

Child Node	Attribute	Value	Parameter Description	Mandatory
Detector		NEG POS SAMP RMS AVER		No (if specified, it has to be equal in all ranges)
Sweep	Mode	Manual Auto		Yes
	Time	<time in sec>		No
Amplitude				No
ReferenceLevel	Value	<power in dBm>		Yes, if the ReferenceLevel child node is used
	Unit	dBm		Yes, if the ReferenceLevel child node is used
RF Attenuation	Mode	Manual Auto		Yes, if the ReferenceLevel child node is used

ASCII File Export Format (Spectrum Emission Mask)

The first part of the file lists information about the spectrum analyzer and the general setup.

File Content	Description
RefType;CPOWER; TxBandwidth;9540000M;Hz FilterState; ON; Alpha;0.22; PeaksPerRange;1; Values;4; 0;-22500000;-9270000;1000000;2986455000; -74.762840270996094;-10.576210021972656; -45.762840270996094;PASS; 1;-9270000;-4770000;1000000;2991405000; -100.17695617675781;-35.990325927734375; -1.490325927734375;PASS 3;4770000;9270000;1000000;3005445000; -100.17695617675781;-35.990325927734375 ;-1.490325927734375;PASS; 4;9270000;22500000;1000000;3018225000; -74.762840270996094;-10.576210021972656; -45.762840270996094;PASS;	Reference range settings Evaluation list information information about each peak: <range number>; <start frequency> <stop frequency> <resolution bandwidth of range> <frequency of peak> <absolute power of peak in dBm> <relative power of peak in dBc> (related to the channel power) <distance to the limit line in dB> (positive value means above the limit line) <limit fail> (pass = 0, fail = 1)

SPECTRUM EMISSION MASK

SPEC EM (ON OFF)		
SWEEP LIST ↓	EDIT SWEEP LIST	
	INS BEFORE RANGE	
	INS AFTER RANGE	
	DELETE RANGE	

	NEXT RANGES	
	PREVIOUS RANGES	
	REFERENCE RANGE ↓	POW REF CHAN PEAK
		TX BANDWIDTH
		RRC FILT (ON OFF)
		ALPHA BT
	START MEAS	
	STOP MEAS	
LIST EVAL ↓	LIST EVAL ON OFF	
	MARGIN	
LOAD STANDARD		
RESTORE STANDARDS		
START MEAS		
STOP MEAS		

SPEC EM (ON OFF) Switches the Spectrum Emission Mask measurement on or off according to the current configuration.

Remote command: SENS:SWE:MODE ESP
 INIT:ESP

SWEEP LIST Opens a submenu to edit the sweep list and displays the *SWEEP LIST* dialog box. After a preset, the sweep list contains a set of default ranges and parameters. For each range, you can change the parameters listed below. To insert or delete ranges, use the *INS BEFORE RANGE*, *INS AFTER RANGE* and *DELETE RANGE* softkeys.

SWEEP LIST					
	RANGE 1	RANGE 2 Ref	RANGE 3	RANGE 4	RANGE 5
Range Start	-250 MHz	-2.52 MHz	2.52 MHz		
Range Stop	-2.52 MHz	2.52 MHz	250 MHz		
Filter Type	NORMAL	NORMAL	NORMAL		
RBW	30 kHz	30 kHz	30 kHz		
VBW	10 MHz	10 MHz	10 MHz		
Sweep Time Mode	AUTO	AUTO	AUTO		
Sweep Time	270 ms	10 ms	270 ms		
Ref Level	-10 dBm	-10 dBm	-10 dBm		
RF Att Mode	AUTO	AUTO	AUTO		
RF Attenuator	15 dB	15 dB	15 dB		
PRE AMP	OFF	OFF	OFF		
Transd Factor	<NONE>	<NONE>	<NONE>		
Limit Check	ON	ON	ON		
Limit	-13 dBm	-13 dBm	-13 dBm		
Abs Limit Start	-13 dBm	-13 dBm	-13 dBm		
Abs Limit Stop	-13 dBm	-13 dBm	-13 dBm		
Rel Limit Start	-50 dBc	-50 dBc	-50 dBc		
Rel Limit Stop	-50 dBc	-50 dBc	-50 dBc		

EDIT SWEEP LIST	
INS BEFORE RANGE	
INS AFTER RANGE	
DELETE RANGE	
NEXT RANGES	
PREVIOUS RANGES	
REFERENCE RANGE ↓	POW REF CHAN PEAK
	TX BANDWIDTH
	RRC FILT (ON OFF)
	ALPHA BT
START MEAS	
STOP MEAS	

EDIT SWEEP LIST

Configures the sweep list.

- Range Start

Start frequency of the range (relative to Center Frequency = Carrier Frequency)

Remote command: `ESP:RANG1:STAR 1000000`

- Range Stop

Stop frequency of the range (relative to Center Frequency = Carrier Frequency)

Remote command: `ESP:RANG1:STOP 10000000`

- Filter Type

Normal (3 dB), EMI (6 dB), Channel, RRC

Remote command: `ESP:RANG1:FILT:TYPE RRC`

- RBW

Resolution filter bandwidth

Remote command: `ESP:RANG1:BAND:RES 5000`

- VBW

Video filter bandwidth; not applicable for Channel and RRC filters.

Remote command: `ESP:RANG1:BAND:VID 5000000`

- Sweep Time Mode

AUTO, MANUAL

Remote command: `ESP:RANG1:SWE:TIME:AUTO ON`

- Sweep Time

Shows the current sweep time. The R&S ESCI automatically calculates the sweep time if AUTO mode is selected and displays the corresponding value in this field. If the field is edited, the sweep time mode is automatically set to MANUAL.

Remote command: `ESP:RANG1:SWE:TIME 1`

- REF Level

Reference level in dBm. The uppermost grid line in the measurement diagram represents the reference level, corrected by the associated transducer factor.

The unit depends on the unit selected via the UNIT softkey.

Remote command: `ESP:RANG1:RLEV 0`

- RF Attenuator Mode

AUTO, MANUAL

Remote command: `ESP:RANG1:INP:ATT:AUTO ON`

- RF Attenuator

Shows the current RF attenuation. The R&S ESCI automatically calculates the RF attenuation if AUTO mode is selected and displays the corresponding value in this field. If the field is edited, the RF Attenuator mode is automatically set to MANUAL.

Remote command: `ESP:RANG1:INP:ATT 10`

- PRE AMP

Activates (ON) or deactivates (OFF) the preamplifier if option R&S FSP-B25 is installed.

Remote command: `ESP:RANG1:INP:GAIN:STAT ON`

- Transd. Factor

Shows the name of the transducer factor that is used for the measurement, or NONE if no transducer factor is selected.

To select a transducer factor highlight this field with the rotary knob and press the ENTER key to open the transducer selection list. Select the name of the transducer factor you need with the rotary knob or NONE if you have to work without a transducer factor.

Remote command: `ESP:RANG1:TRAN <string>`

- Limit Check

Sets the type of limit check for all ranges.

ABSOLUTE:

Checks only the defined absolute limits.

RELATIVE:

Checks only the relative limits. Relative limits are defined as relative to the measured power in the reference range.

ABS & REL:

Combines the absolute and relative limit. The limit check fails when both limits are violated.

ABS or REL:

Combines the absolute and relative limit. The limit check fails when one of the limits is violated.

Remote command: `ESP:RANG1:LIM:STAT ABS`

- Abs Limit Start

Sets the absolute limit value at the start frequency of the range. The unit depends on the unit selected via the UNIT softkey.

Remote command: `ESP:RANG1:LIM:ABS:STAR 10`

- Abs Limit Stop

Sets the absolute limit value at the stop frequency of the range. The unit depends on the unit selected via the UNIT softkey.

Remote command: `ESP:RANG1:LIM:ABS:STOP 20`

- Rel Limit Start

Sets the relative limit value at the start frequency of the range. The unit is dBc.

Remote command: `ESP:RANG1:LIM:REL:STAR -20`

- Rel Limit Stop

Sets the relative limit value at the stop frequency of the range. The unit is dBc.

Remote command: `ESP:RANG1:LIM:REL:STOP -20`

INS BEFORE RANGE

Inserts a range to the left of the current range / column of the sweep list.

Remote command: `ESP:RANG1:INS:BEF`

INS AFTER RANGE

Inserts a range to the right of the current range / column of the sweep list.

Remote command: `ESP:RANG1:INS:BEF`

DELETE RANGE

Deletes the current range / column from the sweep list. All ranges above the deleted one are adjusted by one (e.g. Range 6 turns to Range 5).

NEXT RANGES

Scrolls through the sweep list in forward direction if more than 5 ranges are defined. The first page shows Range 1 through 5, the second page shows Range 6 to 11 etc.

PREVIOUS RANGES	Scrolls through the sweep list in backwards direction if more than 5 ranges are defined. The first page shows Range 1 through 5, the second page shows Range 6 to 11 etc.				
REFERENCE RANGE	<p>Opens a submenu to define additional parameters for the reference power measurement.</p> <table border="1" style="margin-left: 20px; border-collapse: collapse;"> <tr><td style="padding: 2px;">POW REF CHAN PEAK</td></tr> <tr><td style="padding: 2px;">TX BANDWIDTH</td></tr> <tr><td style="padding: 2px;">RRC FILT (ON OFF)</td></tr> <tr><td style="padding: 2px;">ALPHA BT</td></tr> </table>	POW REF CHAN PEAK	TX BANDWIDTH	RRC FILT (ON OFF)	ALPHA BT
POW REF CHAN PEAK					
TX BANDWIDTH					
RRC FILT (ON OFF)					
ALPHA BT					
POW REF CHAN PEAK	<p>Selects the type of power measurement in the reference range.</p> <ul style="list-style-type: none"> • Peak Measures the highest peak within the reference range. • Chan Measures the channel power within the reference range (integral bandwidth method). <p>Remote command: ESP:RTYP PEAK</p>				
TX BANDWIDTH	<p>Defines the bandwidth used for measuring the channel power. Possible values are from 20 Hz to the span of the reference range.</p> <p>Remote command: ESP:BWID 20 HZ</p>				
RRC FILT (ON OFF)	<p>Activates or deactivates the RRC filter.</p> <p>Remote command: ESP:FILT:RRC:STAT ON</p>				
ALPHA BT	<p>Sets the rolloff factor of the RRC filter.</p> <p>Remote command: ESP:FILT:RRC:ALPH 0.22</p>				
START MEAS	<p>Starts the Spectrum Emission Mask measurement. In Single Sweep mode, the R&S ESCI automatically stops the measurement.</p> <p>Remote command: INIT:ESP</p>				
STOP MEAS	<p>Stops the Spectrum Emission Maskj measurement.</p> <p>Remote command: ABOR</p>				
LIST EVAL	<p>Opens a submenu to edit the list evaluation settings.</p> <table border="1" style="margin-left: 20px; border-collapse: collapse;"> <tr><td style="padding: 2px;">LIST EVAL ON OFF</td></tr> <tr><td style="padding: 2px;">MARGIN</td></tr> </table>	LIST EVAL ON OFF	MARGIN		
LIST EVAL ON OFF					
MARGIN					

LIST EVAL ON OFF	<p>Activates or deactivates the list evaluation.</p> <p>A peak search evaluation is performed automatically during the measurement. The results are displayed in a table below the measurement diagram.</p> <p>By default, the list evaluation is active.</p> <p>The evaluation table shows the following results:</p> <ul style="list-style-type: none">• frequency range• frequency of the absolute peak power in the corresponding range.• frequency of the relative peak power in the corresponding range in dBc.• difference between the limit line and the current power level in dB.• result of the limit check (color and an asterisk indicate a failed limit check). <p>The trace, limit line, result of the limit check and the channel power of the reference range are displayed in full screen, too, if the LIST EVALUATION is inactive.</p> <p>Remote command: <code>CALC:ESP:PSE:AUTO ON</code></p>
MARGIN	<p>Opens an edit dialog box to enter the margin used for the limit check/peak search.</p>
LOAD STANDARD	<p>Opens a dialog box to select a customized standard in the *.xml file format. Refer to the description of “Provided XML Files for the Spectrum Emission Mask Measurement” on page 4.193 and “Format Description of Spectrum Emission Mask XML files” on page 4.196 for more information on provided standards and customizing standards.</p>
RESTORE STANDARDS	<p>Restores the original *.xml files that came with the R&S ESCI. Note that files of the same name are overwritten.</p>

4.7 Basic Settings

In this section, all mode-independent functions are described. If a softkey is only available in a special mode, the corresponding mode is indicated in the softkey description.

4.7.1 Setup of Limit Lines and Display Lines – LINES Key

Limit lines are used to define amplitude curves or spectral distribution boundaries on the display screen which are not to be exceeded. They indicate, for example, the upper limits for interference radiation or spurious waves which are allowed from a unit under test (UUT). For transmission of information in TDMA (e.g. GSM), the amplitude of the bursts in a timeslot must adhere to a curve which must fall within a specified tolerance band. The lower and upper limits may each be specified by a limit line. Then, the amplitude curve can be controlled either visually or automatically for any violations of the upper or lower limits (GO/NOGO test).

The instrument supports limit lines with a maximum of 50 data points. 8 of the limit lines stored in the instrument can be used simultaneously and activated in the split-screen mode either in Screen A, Screen B or in the two windows. The number of limit lines stored in the instrument is only limited by the capacity of the flash disk used.

For each limit line, the following characteristics must be defined:

- The name of the limit line. The limit line data are stored under this name and can be examined in the table *LIMIT LINES*.
- The domain in which the limit line is to be used. Here, a distinction is made between the time domain (span = 0 Hz, analyzer mode only) and the frequency domain (span > 0 Hz).
- The reference of the interpolation points to the x-axis. The limit line may be specified either for absolute frequencies or times or for frequencies which are related to the set center frequency and times related to the time on the left edge of the diagram. In receiver mode, only absolute scaling is used.
- The reference of the interpolation points to the y-axis. The limit line can be selected either for absolute levels or voltages or referred to the set maximum level (Ref Lvl). The position on the display depends on the *REF LEVEL POSITION*. In receiver mode, only absolute scaling is used.
- With relative reference values for the y-axis, it is possible to enter an absolute threshold (THRESHOLD) which lowers the relative limit values (see below, analyzer mode only).
- The type of limit line (upper or lower limit, lower limit for analyzer mode only). With this information and the active limit checking function (Table *LIMIT LINES*, *LIMIT CHECK ON*, analyzer mode only), the R&S ESCI checks for compliance with each limit.
- The limit line units to be used. The units of the limit line must be compatible with the level axis in the active measurement window.
- The measurement curve (trace) to which the limit line is assigned. For the R&S ESCI, this defines the curve to which the limit is to be applied when several traces are simultaneously displayed.
- For each limit line, a margin can be defined which serves as a threshold for automatic evaluation.

- In addition, commentary can be written for each limit line, e.g. a description of the application.

Display lines are exclusively used to optically mark relevant frequencies or points in time (span = 0) as well as constant level values. It is not possible to check automatically whether the marked level values have been underranged or exceeded.

4.7.1.1 Selection of Limit Lines

LINES

The *LINES* key opens the menu for fixing the limit lines and the display lines.

SELECT LIMIT LINE	
EDIT LIMIT LINE / NEW LIMIT LINE ↓	NAME
	VALUES
	INSERT VALUE
	DELETE VALUE
	SHIFT X LIMIT LINE
	SHIFT Y LIMIT LINE
	SAVE LIMIT LINE
COPY LIMIT LINE	
DELETE LIMIT LINE	
X OFFSET	
Y OFFSET	
DISPLAY LINES ↓	DISPLAY LINE 1 / DISPLAY LINE 2
	FREQUENCY LINE 1/ FREQUENCY LINE 2
	TIME LINE 1 / TIME LINE 2

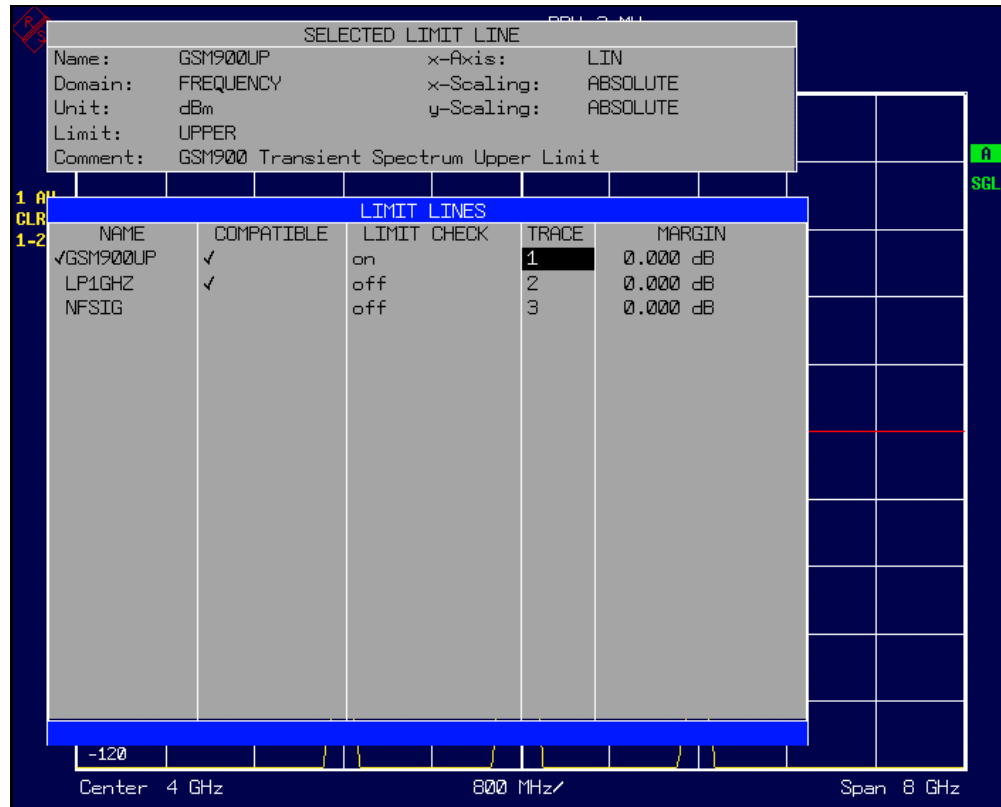

The *SELECTED LIMIT LINE* display field provides information concerning the characteristics of the marked limit lines.

In the *LIMIT LINES* table, the limit lines compatible to the settings of the active screen can be enabled.

New limit lines can be specified and edited in the *NEW LIMIT LINE* and *EDIT LIMIT LINE* submenus, respectively.

The horizontal and vertical lines of the *DISPLAY LINES* submenu mark individual levels or frequencies (span > 0) or times (span = 0) in the diagram.

The *SELECTED LIMIT LINE* table provides information about the characteristics of the marked limit line:

<i>Name</i>	name
<i>Domain</i>	frequency or time
<i>Unit</i>	vertical scale
<i>X-Axis</i>	interpolation
<i>Limit</i>	upper/lower limit
<i>X-Scaling</i>	absolute or relative frequencies/times
<i>Y-Scaling</i>	absolute or relative Y units
<i>Threshold</i>	absolute limit with relative Y units
<i>Comment</i>	commentary

The characteristics of the limit line are set in the *EDIT LIMIT LINE* (=NEW LIMIT LINE) submenu.

SELECT LIMIT LINE

The *SELECT LIMIT LINE* softkey activates the *LIMIT LINES* table and the selection bar jumps to the uppermost name in the table.

The following information is offered in the columns of the table:

<i>Name</i>	Enable the limit line.
<i>Compatible</i>	Indicates if the limit line is compatible with the measurement window of the given trace.
<i>Limit Check</i>	Activate automatic violation check for upper/lower limits.
<i>Trace</i>	Select the measurement curve to which the limit is assigned.
<i>Margin</i>	Define margin.

Name and Compatible - Enabling limit lines

A maximum of 8 limit lines can be enabled at any one time. In split screen mode, they may be assigned to screen A, screen B or to both screens. A check mark at the left edge of a cell indicates that this limit line is enabled.

A limit line can only be enabled when it has a check mark in the *Compatible* column, i.e. only when the horizontal display (time or frequency) and vertical scales are *identical* to those of the display in the measurement window.

Lines with the unit dB are compatible to all dB(..) settings of the y-axis.

If the scale of the y-axis or the domain (frequency or time axis) are changed, all non-compatible limit lines are automatically switched off in order to avoid misinterpretation. The limit lines must be enabled anew when the original display is re-displayed.

Remote command: `CALC:LIM3:NAME "GSM1"`
 `CALC:LIM3:UPP:STAT ON`
 `CALC:LIM4:LOW:STAT ON`

Limit Check - Activate automatic limit violation check (analyzer mode only)

When *LIMIT CHECK ON* is activated, a GO/NOGO test is performed in the active screen. In the center of the diagram, a display window appears which indicates the results of the limit check test:

LIMIT CHECK: PASSED	No violations of active limits.
LIMIT CHECK: FAILED	One or more active limit lines were violated. The message contains the names of the limit lines which were violated or whose margins were not complied with.
LIMIT CHECK: MARGIN	The margin of at least one active limit lines was not complied with, however, no limit line was violated. The message contains the names of the limit lines whose margins were not complied with.

The following example shows two active limit lines:

```
LIMIT CHECK: FAILED
LINE VHF_MASK: Failed
LINE UHF2MASK: Margin
```

A check for violations of limit lines takes place only if the limit line of the assigned measurement curve (trace) is enabled.

In the receiver mode, no limit check is possible.

If *LIM CHECK* is set to *OFF* for all active limit lines, then the limit line check is not executed and the display window is activated.

Remote command: `CALC:LIM:STAT ON`
 `INIT;*WAI`
 `CALC:LIM:FAIL?`

Trace - Select the measurement curve to which the limit line is assigned.

The selection of the measurement curve (trace) takes place in an entry window. Allowed are the integer entries 1, 2 or 3. The default setting is trace 1. If the selected limit line is not compatible with the assigned measurement curve, then the limit line is disabled (display and limit check).

Remote command: `CALC:LIM:TRAC 1`

NEW LIMIT LINE

See following section [“Entry and Editing of Limit Lines” on page 4.213.](#)

EDIT LIMIT LINE

See following section [“Entry and Editing of Limit Lines” on page 4.213.](#)

COPY LIMIT LINE

The *COPY LIMIT LINE* softkey copies the data file describing the marked limit line and saves it under a new name. In this way, a new limit line can be easily generated by parallel translation or editing of an existing limit line. The name can be arbitrarily chosen and input via an entry window (max. of 8 characters).

Remote command: `CALC:LIM3:COPY 2`
 `or`
 `CALC:LIM3:COPY "GSM2"`

DELETE LIMIT LINE

The *DELETE LIMIT LINE* softkey erases the selected limit line. Before deletion, a message appears requesting confirmation.

Remote command: `CALC:LIM3:DEL`

X OFFSET

The *X OFFSET* softkey horizontally shifts a limit line, which has been specified for relative frequencies or times (x-axis). The softkey opens an entry window, where the value for shifting may be entered numerically or via the rotary knob.



This softkey does not have any effect on limit lines that represent absolute values for the x-axis.

Remote command: `CALC:LIM3:CONT:OFFS 10kHz`

Y OFFSET

The *Y OFFSET* softkey vertically shifts a limit line, which has relative values for the y-axis (levels or linear units such as volt). The softkey opens an entry window where the value for shifting may be entered numerically or via the rotary knob.



This softkey does not have any effect on limit lines that represent absolute values for the y-axis.

Remote command: `CALC:LIM3:LOW:OFFS 3dB`
 `CALC:LIM3:UPP:OFFS 3dB`

4.7.1.2 Entry and Editing of Limit Lines



A limit line is characterized by

- its name
- the assignment of domain (frequency or time)
- the scaling in absolute or relative times or frequencies
- the vertical unit
- the interpolation
- the vertical scaling
- the vertical threshold (only with relative vertical scaling)
- the margin
- the definition of the limit line as either upper or lower limit.
- the data points for frequency/time and level.

At the time of entry, the R&S ESCI immediately checks that all limit lines are in accordance with certain guidelines. These guidelines must be observed if specified operation is to be guaranteed.

- The frequencies/times for each data point must be entered in ascending order, however, for any single frequency/time, two data points may be input (vertical segment of a limit line).

The data points are allocated in order of ascending frequency/time. Gaps are not allowed. If gaps are desired, two separate limit lines must be defined and then both enabled.

- The entered frequencies/times need not necessarily be selectable in R&S ESCI. A limit line may also exceed the specified frequency or time domains. The minimum frequency for a data point is -200 GHz, the maximum frequency is 200 GHz. For the time domain representation, negative times may also be entered. The valid range is -1000 s to +1000 s.
- The minimum/maximum value for a limit line is -200 dB to +200 dB for the logarithmic or 10^{-20} to 10^{+20} or -99.9% to + 999.9% for the linear amplitude scales.

EDIT LIMIT LINE / NEW LIMIT LINE

NAME
VALUES
INSERT VALUE
DELETE VALUE
SHIFT X LIMIT LINE
SHIFT Y LIMIT LINE
SAVE LIMIT LINE

The *EDIT LIMIT LINE* and *NEW LIMIT LINE* softkeys both call the *EDIT LIMIT LINE* submenu used for editing limit lines. In the table heading, the characteristics of the limit line can be entered. The data points for frequency/time and level values are entered in the columns.

<i>Name</i>	Enter name.
<i>Domain</i>	Select domain.
<i>Unit</i>	Select units.
<i>X-Axis</i>	Select interpolation
<i>Limit</i>	Select upper and lower limit value.
<i>X-Scaling</i>	Entry of absolute or relative values for the x-axis
<i>Y-Scaling</i>	Entry of absolute or relative values for the y-axis
<i>Margin</i>	Entry of margin.
<i>Threshold</i>	Entry of vertical threshold (only with relative vertical scaling)
<i>Comment</i>	Enter comments.
<i>Time/Frequency</i>	Enter time/frequency for the data points.
<i>Limit/dBm</i>	Enter magnitudes for the data points.



Domain, unit, X scaling and Y scaling cannot be modified as soon as reference values have been entered in the data section of the table.

NAME The *NAME* softkey enables the entry of characteristics in the table heading.

Name - Enter name

A maximum of 8 characters is permitted for each name. All names must be compatible with the MS DOS conventions for file names. The instrument stores all limit lines with the *.LIM* extension.

Remote command: `CALC:LIM3:NAME "GSM1"`

Domain - Select time or frequency domain

The default setting is frequency.



A change in domain (frequency/time) is only permitted when the data point table is empty.

Remote command: `CALC:LIM3:CONT:DOM FREQ`

X-Axis - Select interpolation

Linear or logarithmic interpolation can be carried out between the frequency reference points of the table. The ENTER key toggles between LIN and LOG selection.

Remote command: `CALC:LIM3:CONT:SPAC LIN`
`CALC:LIM3:UPP:SPAC LIN`
`CALC:LIM3:LOW:SPAC LIN`

Scaling - selection of absolute or relative scaling

The limit line can either be scaled in absolute (frequency or time) or relative units. In receiver mode, only absolute scaling is used. Any of the unit keys may be used to toggle between *ABSOLUTE* and *RELATIVE*, the cursor must be positioned in the *X-Scaling* or the *Y-Scaling* line.

X-Scaling ABSOLUTE The frequencies or times are interpreted as absolute physical units.

X-Scaling RELATIVE In the data point table, the frequencies are referred to the currently set center frequency. In time domain mode, the left boundary of the diagram constitutes the reference.

Y-Scaling ABSOLUTE The limit values refer to absolute levels or voltages.

Y-Scaling RELATIVE The limit values refer to the reference level (Ref Level) or, in case a reference line is set, to the reference line.

Limit values with the unit dB are always relative values.

The *RELATIVE* scaling is always suitable, if masks for bursts are to be defined in the time domain, or if masks for modulated signals are required in the frequency domain.

An X offset with half the sweep time may be entered in order to shift the mask in the time domain into the center of screen.

Remote command: `CALC:LIM3:CONT:MODE ABS`
 `CALC:LIM3:UPP:MODE ABS`
 `CALC:LIM3:LOW:MODE ABS`

Unit - Select the vertical scale units for the limit line

The selection of units takes place in a selection box. The default setting is dBm.

Remote command: `CALC:LIM3:UNIT DBM`

Limit - Select upper/lower limit

A limit line can be defined as either an upper or lower limit. In receiver mode, only the upper limit line is used.

Remote command: `--` (defined by key words `:UPPER` or `:LOWER`)

Margin - Setting a margin.

The margin is defined as the signal-level distance to the limit line. When the limit line is defined as an upper limit, the margin means that the level is below the limit line. When the limit line is defined as a lower limit, the margin means that the level is above the limit line. The default setting is 0 dB (i.e. no margin).

Remote command: `CALC:LIM3:UPP:MARG 10dB`
 `CALC:LIM3:LOW:MARG 10dB`

Threshold – Selection of the threshold value with relative Y scaling

With relative Y scaling, an absolute threshold value can be defined which lowers the relative limit values. The function is useful especially for mobile radio applications provided the limit values are defined in relation to the carrier power as long as they are above an absolute limit value.

Example:

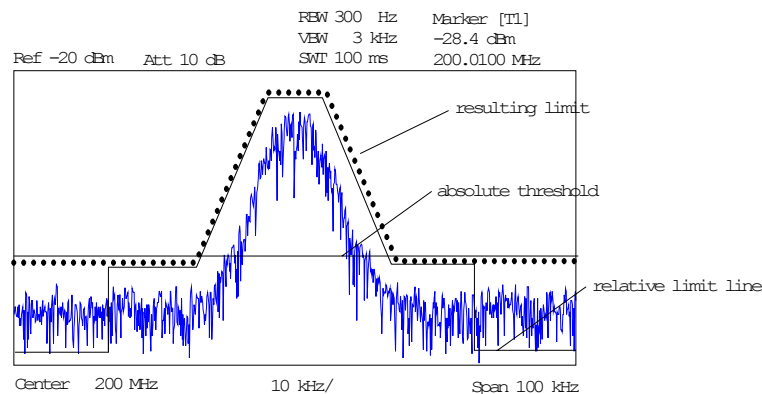

The preset value is at -200 dBm. The field is displayed if the value RELATIVE is entered in the field Y-SCALING.

Remote command: `CALC:LIM3:UPP:THR -30 dBm`
 or
 `CALC:LIM3:LOW:THR -30 dBm`

Comment - Enter comments

Comments are arbitrary, however, they must be less than 41 characters long.

Remote command: `CALC:LIM3:COMM "Upper limit"`

VALUES The *VALUES* softkey activates the entry of the data points in the table columns *Time/Frequency* and *Limit/dB*. Which table columns appear depends upon the *Domain* selection in the table heading.

The desired frequency/time data points are entered in ascending order (two repeated frequencies/time values are permitted).

Remote command: `CALC:LIM3:CONT:DATA 1MHz, 3MHz, 30MHz`
 `CALC:LIM3:UPP:DATA -10, 0, 0`
 `CALC:LIM3:LOW:DATA -30, -40, -40`

INSERT VALUE The *INSERT VALUE* softkey creates an empty line above the current cursor position where a new data point may be entered. However, during the entry of new values, it is necessary to observe an ascending order for frequency/time.

Remote command: `--`

DELETE VALUE The *DELETE VALUE* softkey erases the data point (complete line) at the cursor position. All succeeding data points are shifted down accordingly.

Remote command: `--`

SHIFT X LIMIT LINE The *SHIFT X LIMIT LINE* softkey calls an entry window where the complete limit line may be shifted parallel in the horizontal direction.

The shift takes place according to the horizontal scale:

- in the frequency domain in Hz, kHz, MHz or GHz
- in the time domain in ns, μ s, ms or s

In this manner, a new limit line can be easily generated based upon an existing limit line which has been shifted horizontally and stored (*SAVE LIMIT LINE* softkey) under a new name (*NAME* softkey).

Remote command: `CALC:LIM3:CONT:SHIF 50KHz`

SHIFT Y LIMIT LINE The *SHIFT Y LIMIT LINE* softkey calls an entry window where the complete limit line may be shifted parallel in the vertical direction.

The shift takes place according to the vertical scale:

- for logarithmic units, relative, in dB
- for linear units, as a factor

In this manner, a new limit line can be easily generated based upon an existing limit line which has been shifted vertically and stored (*SAVE LIMIT LINE* softkey) under a new name (*NAME* softkey).

Remote command: `CALC:LIM3:CONT:UPP:SHIF 20dB`
 `CALC:LIM3:CONT:LOW:SHIF 20dB`

SAVE LIMIT LINE The *SAVE LIMIT LINE* softkey stores the currently edited limit line. The name can be entered in an input window (max. 8 characters)

Remote command: `--`

4.7.1.3 Display Lines

Display lines help to evaluate a trace – as do markers. The function of a display line is comparable to that of a ruler that can be shifted on the trace in order to mark absolute values.

The R&S ESCI provides two different types of display lines:

- two horizontal level lines for marking levels – Display Line 1/2,
- two vertical frequency or time lines for marking frequencies or points in time – Frequency/Time Line 1/2.

Each line is identified by one of the following abbreviations:

D1 Display Line 1
 D2 Display Line 2
 F1 Frequency Line 1
 F2 Frequency Line 2
 T1 Time Line 1
 T2 Time Line 2

The level lines are continuous horizontal lines across the entire width of a diagram and can be shifted in y direction.

The frequency or time lines are continuous vertical lines across the entire height of the diagram and can be shifted in x direction.

The *DISPLAY LINES* submenu for activating and setting the display lines appears different depending on the display mode set in the active measurement window (frequency or time domain).

If the spectrum is shown (span \neq 0) the *TIME LINE 1* and *TIME LINE 2* softkeys are disabled, whereas in the time domain (span = 0) the *FREQUENCY LINE 1* and *FREQUENCY LINE 2* softkeys are not available.

Working with display lines

The softkeys for setting and switching the display lines on/off work like triple switches:

Initial situation: The line is off (softkey with gray background)

1st press: The line is switched on (softkey with red background) and the data input function is activated. The position of the display line can be selected by means of the rotary knob, the step keys or a numerical entry in the appropriate field. The data input function is disabled if another function is activated. The line, however, remains switched on (softkey with green background).

2nd press: The line is switched off (softkey with gray background).

Initial situation: The line is on (softkey with green background)

1st press: The data input function is activated (softkey with red background). The position of the display line can be selected by means of the rotary knob, the step keys or a numerical entry in the appropriate field. The data input function is disabled if another function is activated. The line, however, remains switched on (softkey with green background).

2nd press: The line is switched off (softkey with gray background).

DISPLAY LINES

DISPLAY LINE 1 / DISPLAY LINE 2
FREQUENCY LINE 1/ FREQUENCY LINE 2
TIME LINE 1 / TIME LINE 2

DISPLAY LINE 1 /
DISPLAY LINE 2 The *DISPLAY LINE 1/2* softkeys enable or disable the level lines and allow the user to enter the position of the lines.

The level lines mark the selected level in the measurement window.



These softkeys are only available in the time domain (span = 0).

Remote command: `CALC:DLIN:STAT ON`
`CALC:DLIN -20dBm`

FREQUENCY LINE 1/
FREQUENCY LINE 2 The *FREQUENCY LINE 1/2* softkeys enable or disable the frequency lines 1/2 and allow the user to enter the position of the lines.

The frequency lines mark the selected frequencies in the measurement window.



These softkeys are only available in the frequency domain (span > 0).

Remote command: `CALC:FLIN:STAT ON`
`CALC:FLIN 120MHz`

TIME LINE 1 /
TIME LINE 2 The *TIME LINE 1/2* softkeys enable or disable the time lines 1/2 and allow the user to enter the position of the lines.

The time lines mark the selected times or define search ranges (see section “[Marker Functions – MKR FCTN Key](#)” on page 4.123).



The two softkeys cannot be used in the frequency domain (span > 0).

Remote command: `CALC:TLIN:STAT ON`
 `CALC:TLIN 10ms`

4.7.2 Configuration of Screen Display – DISP Key

The *DISPLAY* menu allows the configuration of the diagram display on the screen and also the selection of the display elements and colors. The *POWER SAVE* mode is also configured in this menu for the display.

The test results are displayed on the screen of the R&S ESCI either in a full-screen window or in two overlapping windows. The two windows are called diagram A and diagram B.

In the default setting, the two windows are completely decoupled from each other, i.e. they behave like two separate instruments. This is very useful, for example with harmonics measurements or measurements on frequency-converting DUTs, since the input signal and the output signal lie in different frequency ranges.

However, specific settings of the two windows (reference level, center frequency) can be coupled, if required, so that with *CENTER B = MARKER A* for example, the shift of the marker in diagram A causes the frequency range (zoomed in some cases) to be shifted along diagram B.

In the default setting, the upper half of the screen shows the bar graph measurement of the receiver (screen A) and the lower half shows the sweep of the analyzer (screen B). Various instrument settings such as RF attenuation are coupled together for the two measurement screens, i.e. changing a setting in one of the measurement screens automatically changes it in the other screen. You can define which instrument settings are to be coupled from the *PARAM COUPLING* menu.

New settings are performed in the diagram selected via *SCREEN A* or *SCREEN B* hotkey. If only one window is displayed, it is the diagram in which the measurements are performed; the diagram not displayed is not active for measurements.

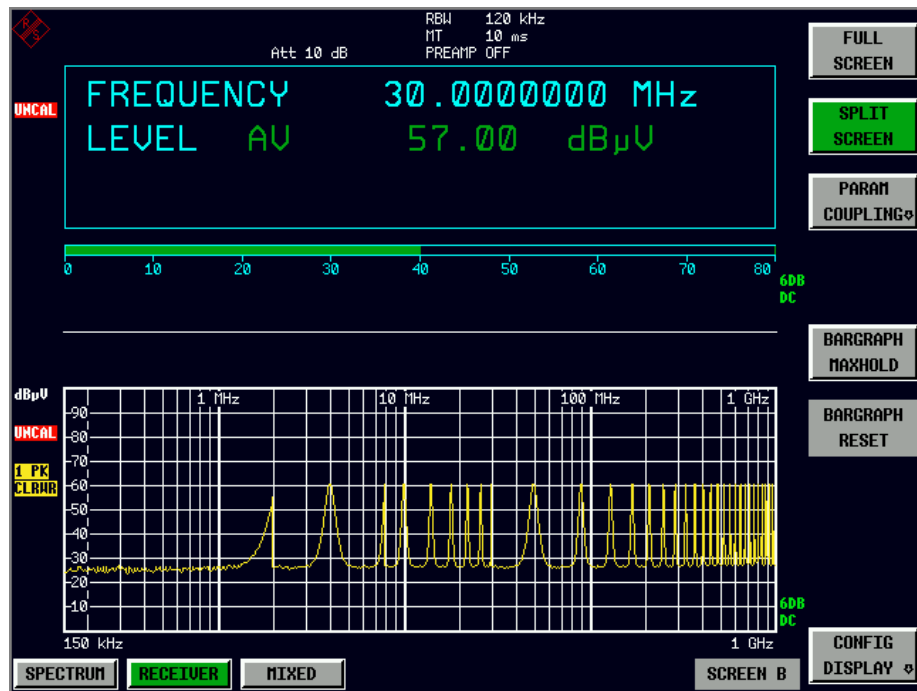

Fig. 4.16 Typical split-screen display

The *DISP* key opens the menu for configuring the screen display and selecting the active diagram in SPLIT SCREEN mode.

DISP

FULL SCREEN	
SPLIT SCREEN	
PARAM COUPLING	COUPLING TABLE
	DEFAULT CONFIG
	ENABLE ALL ITEMS
	DISABLE ALL ITEMS
REF LEVEL COUPLED (Analyzer Mode only)	
CENTER B = MARKER A CENTER A = MARKER B (Analyzer Mode only)	
BARGRAPH MAXHOLD (Receiver Mode only)	
BARGRAPH RESET (Receiver Mode only)	
CONFIG DISPLAY ↓	SCREEN TITLE
	TIME+DATE ON/OFF
	LOGO ON/OFF
	ANNOTATION ON/OFF
	DATA ENTRY OPAQUE
	DEFAULT COLORS 1/ DEFAULT COLORS 2

	DISPLAY PWR SAVE
	Side menu
	SELECT OBJECT
	BRIGHTNESS
	TINT
	SATURATION
	PREDEFINED COLORS

FULL SCREEN The *FULL SCREEN* softkey selects the display of one diagram. In analyzer mode, it is possible to switch between two different device settings by selecting the active window (screen A or screen B). In receiver mode, the full screen displays the scan.

Switching between *SCREEN A* and *SCREEN B* is performed by means of the corresponding key in the hotkey bar (for details refer to “[Mode Selection – Hotkey Bar](#)” on page 4.9).

It should be noted that the measurements in the FULL SCREEN mode are performed only in the visible (active) window.

The active window is marked by **A** or **B** on the right of the diagram.

Remote command: `DISP:FORM SING`
 `DISP:WIND<1|2>:SEL`

SPLIT SCREEN The *SPLIT SCREEN* softkey selects the display of two diagrams. The upper diagram is designated *SCREEN A*, the lower diagram *SCREEN B*.

Switching between *SCREEN A* and *SCREEN B* is performed via the corresponding key in the hotkey bar. The active window is marked by highlighting fields **A** and **B** on the right of the diagram.

In receiver mode, screen A displays the receiver bar graph and screen B the scan diagram.

In Mixed mode, two screen combinations are available:

- Level and frequency display (screen A) and analyzer spectrum (screen B)
- or
- Analyzer spectrum (screen B) and scan spectrum (screen B)

Remote command: `DISP:FORM SPL`

PARAM COUPLING The *PARAM COUPLING* softkey opens a submenu and a table to select the coupled parameters of receiver and analyzer mode.

COUPLING TABLE
DEFAULT CONFIG
ENABLE ALL ITEMS
DISABLE ALL ITEMS

PARAMETER COUPLING	
	Frequency
✓	Analyzer Center <-> Receiver Frequency Start - Stop (Sweep <-> Scan) Analyzer Marker Frequency -> Receiver Frequency
	Amplitude
✓	Attenuation + Unit
✓	Minimum Attenuation
✓	Preamplifier
	Other
✓	Preselector Demodulator Bandwidth
Press ENTER to select/deselect field	

COUPLING TABLE The *COUPLING TABLE* softkey opens the PARAMETER COUPLING table.

Remote command:

Analyzer Center	INST:COUP:CENT ALL
Start-Stop	INST:COUP:SPAN ALL
Marker	INST:COUP:MARK ALL
Attenuation, Unit	INST:COUP:ATT ALL
Minimum Attenuation	INST:COUP:PROT ALL
Preamplifier	INST:COUP:GAIN ALL
Preselector	INST:COUP:PRES ALL
Demodulator	INST:COUP:DEM ALL
Bandwidth	INST:COUP:BWID ALL

DEFAULT CONFIG The *DEFAULT CONFIG* softkey activates the preset settings of the PARAMETER COUPLING table.

Remote command: --

ENABLE ALL ITEMS The *ENABLE ALL ITEMS* softkey switches all of the possible couplings to on. The coupling of center frequency is switched on, therefore coupling of start /stop frequency is switched off.

Remote command: --

DISABLE ALL ITEMS The *DISABLE ALL ITEMS* softkey switches all of the possible couplings to off.

Remote command: --

**BARGRAPH
MAXHOLD**

The *BARGRAPH MAXHOLD* switches on the maxhold display of a single measurement.

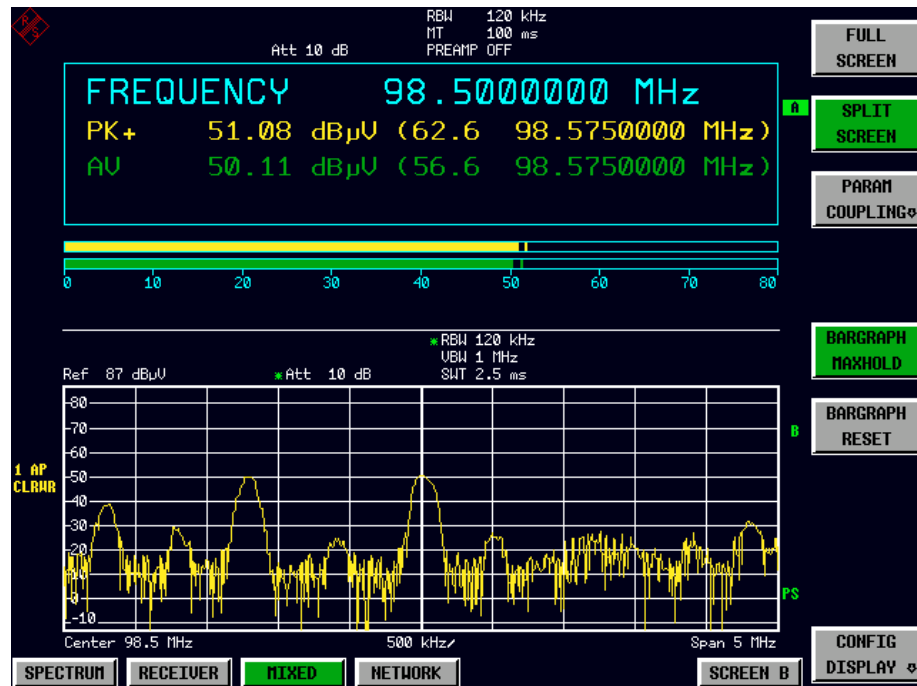

The *BARGRAPH MAXHOLD* softkey changes the display of the results of the bar graph measurement such that both the highest level for each detector and the frequency at which it is measured are displayed. The MAX Hold value will not be automatically reset by the instrument until *BARGRAPH MAXHOLD* is switched off or until, for example, the test receiver mode is deactivated as a result of switching to the analyzer.

Thus, you can also trace fluctuating interference signals in the frequency, and the highest measured value will remain on screen together with the associated frequency.

The softkey is only available in receiver mode.

Remote command: `DISP:BARG:PHOL ON`

**BARGRAPH
RESET**

The *BARGRAPH RESET* softkey resets the stored maximum values of the bar graph measurement.

The softkey is only available in receiver mode.

Remote command: `DISP:BARG:PHOL:RES`

**REF LEVEL
COUPLED**

The *REF LEVEL COUPLED* softkey switches the coupling of the reference level on and off. In addition to the reference level, the mixer level and input attenuation are coupled with one another.

For the level measurement, the same reference level and input attenuation must be set for the two diagrams.

The softkey is only available in analyzer mode.

Remote command: `INST:COUP RLEV`

**CENTER B =
MARKER A |
CENTER A =
MARKER B**

The *CENTER B = MARKER A* and *CENTER A = MARKER B* softkeys couple the center frequency in diagram B with the frequency of marker 1 in diagram A and the center frequency in diagram B with the frequency of marker 1 in diagram B. The two softkeys are mutually exclusive.

This coupling is useful, e.g. for viewing the signal at the marker position in diagram A with higher frequency resolution or in the time domain in diagram B.

If marker 1 is off, it is switched on and set to the maximum of the trace in the active diagram.

The softkeys are only available in analyzer mode.

Remote command: INST:COUP CF_B
 INST:COUP CF_A

**CONFIG
DISPLAY**

SCREEN TITLE
TIME+DATE ON/OFF
LOGO ON/OFF
ANNOTATION ON/OFF
DATA ENTRY OPAQUE
DEFAULT COLORS 1/ DEFAULT COLORS 2
DISPLAY PWR SAVE
Side menu
SELECT OBJECT
BRIGHTNESS
TINT
SATURATION
PREDEFINED COLORS

The *CONFIG DISPLAY* softkey opens a submenu allowing additional display items to be added to the screen. In addition, the display power-save mode (*DISPLAY PWR SAVE* softkey) and the colors of the display elements can be set here.

SCREEN TITLE The *SCREEN TITLE* softkey activates the entry of a title for the active diagram A or B. It switches on or off a title that is already input. The length of the title is limited to max. 20 characters.

Remote command: DISP:WIND1:TEXT 'Noise Meas'
 DISP:WIND1:TEXT:STATE ON

**TIME+DATE
ON/OFF** The *TIME+DATE ON/OFF* softkey switches on or off the display of date and time above the diagram.

Remote command: DISP:TIME OFF

LOGO ON/OFF The *LOGO ON/OFF* softkey switches the Rohde & Schwarz company logo displayed in the upper left corner of the display screen on or off.

Remote command: DISP:LOGO ON

ANNOTATION ON/OFF	<p>The <i>ANNOTATION ON/OFF</i> softkey switches the displaying of frequency information on the screen on and off.</p> <ul style="list-style-type: none"> • ON: Frequency information is displayed. • OFF: Frequency information is not outputted to the display. This can be used for example to protect confidential data. <p>Remote command: <code>DISP:ANN:FREQ ON</code></p>
DATA ENTRY OPAQUE	<p>The <i>DATA ENTRY OPAQUE</i> softkey sets the data entry windows to opaque. This means that entry windows are underlaid with the background color for tables.</p> <p>Remote command: <code>--</code></p>
DEFAULT COLORS 1/ DEFAULT COL ORS 2	<p>The <i>DEFAULT COLORS 1/2</i> softkeys restores the default settings for brightness, color tint and color saturation for all display screen elements.</p> <p>The color schemes have been selected to give optimum visibility of all picture elements at an angle of vision from above or below. <i>DEFAULT COLORS 1</i> is active in the default setting of the instrument.</p> <p>Remote command: <code>DISP:CMAP:DEF1</code> <code>DISP:CMAP:DEF2</code></p>
DISPLAY PWR SAVE	<p>The <i>DISPLAY PWR SAVE</i> softkey is used to switch on/off the power-save mode for the display and to enter the time for the power-save function to respond. After the elapse of this time the display is completely switched off, i.e. including backlighting.</p>



This mode is recommended for saving the TFT display especially when the instrument is exclusively operated in remote control.

The power-save mode is configured as follows:

- The first keystroke activates the power-save mode and opens the editor for the response time. The response time is entered in minutes between 1 and 6 minutes and is confirmed by *ENTER*.
- The power-save mode is deactivated by pressing the key again.

On leaving the menu with the power-save mode in the activated state, the softkey is highlighted in color on returning to the menu and opens again the editor for the response time. Pressing again the key switches off the power-save mode.

Remote command: `DISP:PSAV ON`
 `DISP:PSAV:HOLD 15`

SELECT OBJECT	<p>The <i>SELECT OBJECT</i> softkey activates the <i>SELECT DISPLAY OBJECT</i> table, with which a graphics element can be selected. After selection, the brightness, tint and saturation of the selected element can be changed using the softkeys of the same name. The color changes by means of the <i>PREDEFINED COLORS</i> softkey can be seen immediately on the display screen.</p>
------------------	---

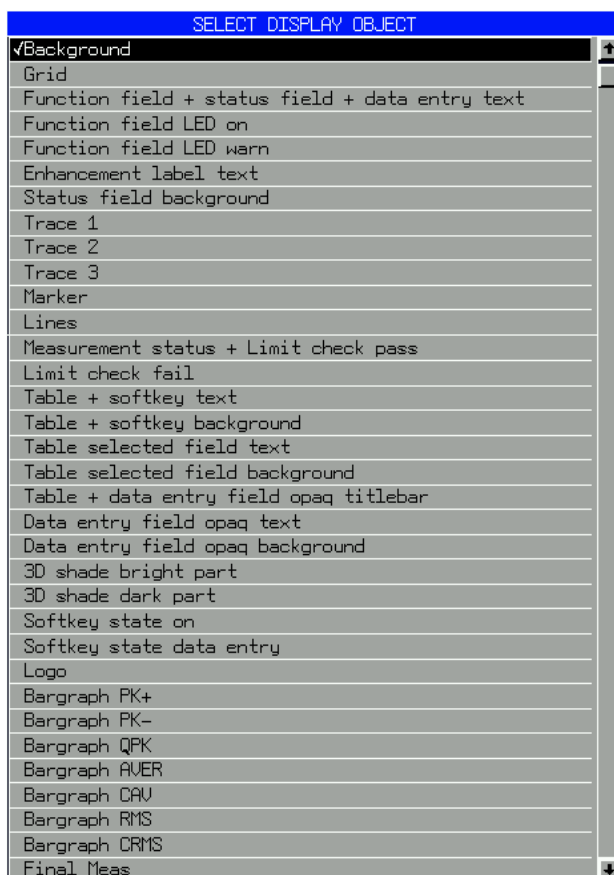

BRIGHTNESS The *BRIGHTNESS* softkey activates entry of the brightness of the selected graphics element.

Values between 0 and 100% can be entered.

Remote command: `DISP:CMAP3:HSL< hue>,<sat>,<lum>`

TINT The *TINT* softkey activates the entry of the color tint of the selected element. The entered value is related to a continuous color spectrum ranging from red (0%) to blue (100%).

Remote command: `DISP:CMAP3:HSL <hue>,<sat>,<lum>`

SATURATION The *SATURATION* softkey activates the entry of the color saturation for the selected element.

The range of inputs is from 0 to 100%.

Remote command: `DISP:CMAP3:HSL <hue>,<sat>,<lum>`

PREDEFINED COLORS The *PREDEFINED COLORS* softkey activates a table, with which the predefined colors for the display screen elements can be selected.

COLOR
√ BLACK
BLUE
BROWN
GREEN
CYAN
RED
MAGENTA
YELLOW
WHITE
GRAY
LIGHT GRAY
LIGHT BLUE
LIGHT GREEN
LIGHT CYAN
LIGHT RED
LIGHT MAGENTA

Remote command: `DISP:CMAP1 to26:PDEF <color>`

4.7.3 Instrument Setup and Interface Configuration – SETUP Key

The *SETUP* key opens the menu for configuration of the R&S ESCI:

SETUP

REFERENCE INT / EXT		
LISN	ESH2-Z5 / ESH3-Z5 / ENV 4200 / ENV 216 / OFF	
	PHASE N / PHASE L1 / PHASE L2 / PHASE L3	
	150 KHZ HIGHPASS	
	PE GROUNDED / PE FLOATING	
PREAMP ON/OFF		
PRESELECT ON/OFF		
TRANSDUCER ↓	TRANSDUCER FACTOR	
	TRANSDUCER SET	
	NEW / EDIT ↓ (TRANSDUCER FACTOR is set)	INSERT LINE
		DELETE LINE
		SAVE TRD FACTOR
	NEW / EDIT ↓ (TRANSDUCER SET is set)	INS BEFORE RANGE
		INS AFTER RANGE
		DELETE RANGE
		RANGES 1-5/6-10

		SAVE TRD SET
	DELETE	
	VIEW TRANSDUCER	
	REFLVL ADJ AUTO MAN	
	PAGE UP	
	PAGE DOWN	
GENERAL SETUP ↓	GPIB ↓	GPIB ADDRESS
		ID STRING FACTORY
		ID STRING USER
		GPIB LANGUAGE
		IF GAIN NORM/PULS
		SWEEP REP ON/OFF
		COUPLING FSP/HP
	USER PORT ↓	USER PORT IN/OUT
		PORT 0 0/1 to PORT 7 0/1
	COM INTERFACE	
	TIME+DATE	
	CONFIGURE NETWORK	COMPUTER NAME
		IP ADDRESS
		SUBNET MASK
		DHCP ON OFF
		CONFIGURE NETWORK
		SHOW CONFIG
	NETWORK LOGIN	
	OPTIONS ↓	INSTALL OPTION
		REMOVE OPTION
	Side menu	
	SOFT FRONTPANEL	
SYSTEM INFO ↓	HARDWARE INFO	
	STATISTICS	
	SYSTEM MESSAGES	
	CLEAR ALL MESSAGES	
SERVICE ↓	INPUT RF	
	INPUT CAL	
	SELFTEST	
	SELFTEST RESULTS	
	ENTER PASSWORD	

	1. Side menu	
	CAL GEN 128 MHZ	
	PULSE 10 kHz / PULSE 100 kHz / PULSE 200 kHz / PULSE 500 kHz / PULSE 1 MHz / PULSE 2 MHz / PULSE 4 MHz / PULSE 8 MHz /	
	2. side menu	
	COMMAND TRACKING	
Side menu		
FIRMWARE UPDATE ↓	FIRMWARE UPDATE	
	RESTORE FIRMWARE	
	UPDATE PATH	
NOISE SRC ON/OFF		
PRESET RECEIVER		
PRESET ANALYZER		
OPEN START MENU		

The following settings can be modified here:

- The *REFERENCE INT/EXT* softkey determines the source of the reference. For details refer to section “[External Reference](#)” on page 4.231.
- The *LISN* softkey opens a submenu for the V-networks (LISNs) control. For details refer to section “[Control of V-Networks \(LISNs\)](#)” on page 4.232.
- The *PREAMP ON/OFF* softkey switches the preamplifier on or off in analyzer mode. For details refer to section “[PREAMP ON/OFF](#)” on page 4.235.
- The *PRESELECT ON/OFF* softkey is used to switch the preselection. For details refer to section “[Preamplification and Preselection](#)” on page 4.233.
- The *TRANSDUCER* softkey opens a submenu for entering the correction characteristics for transducers. For details refer to section “[TRANSDUCER](#)” on page 4.237.
- The *GENERAL SETUP* softkey opens a submenu for all the general settings such as GPIB address, date and time as well as the configuration of the device interfaces. *FIRMWARE OPTIONS* can be installed under this menu item. For details refer to section “[GENERAL SETUP](#)” on page 4.245.
- The *SYSTEM INFO* softkey opens a submenu for displaying the hardware configuration of the instrument, the switching cycle statistics and system messages. For details refer to section “[SYSTEM INFO](#)” on page 4.257.
- The *SERVICE* softkey opens a submenu in which special device functions and system information can be selected for servicing. The password required for service functions can be entered in this submenu. For details refer to section “[SERVICE](#)” on page 4.259.
- The *FIRMWARE UPDATE* opens a submenu to update the firmware version, to restore the firmware and to update the firmware path. For details refer to section “[Firmware Update](#)” on page 4.262.

- The *NOISE SRC ON/OFF* softkey switches on and off the voltage supply for an external noise source. For details refer to section “[External Noise Source](#)” on page 4.263.
- The *RECEIVER PRESET* softkey sets the receiver mode as preset mode. For details refer to “[PRESET RECEIVER](#)” on page 4.263
- The *ANALYZER PRESET* softkey sets the analyzer mode as preset mode. For details refer to “[PRESET ANALYZER](#)” on page 4.263
- The *SERVICE FUNCTIONS* softkey enables additional special settings for servicing and troubleshooting. It is available after entering the corresponding password under the *SERVICE* softkey.

4.7.3.1 External Reference

The R&S ESCI can use the internal reference source or an external reference source as frequency standard from which all internal oscillators are derived. A 10 MHz crystal oscillator is used as internal reference source. In the default setting (internal reference), this frequency is available as output signal at rear-panel connector REF OUT, e.g. to synchronize other instruments to the reference of the R&S ESCI.

In the setting *REFERENCE EXT*, the connector REF IN is used as input connector for an external frequency standard. In this case all internal oscillators of the R&S ESCI are synchronized to the external reference frequency.

REFERENCE INT / EXT

The *REFERENCE INT / EXT* softkey switches between the internal and external reference.

If the external reference is selected, also the frequency of the external reference is adjustable between 1 MHz and 20 MHz. The default value is 10 MHz.

These reference settings are not changed if a preset occurs to maintain the specific setup of a test system.



If the reference signal is missing when switching to external reference, the *EXREF* message appears after a while to indicate that there is no synchronization.

When switching to internal reference ensure that the external reference signal is deactivated to avoid interactions with the internal reference signal.

Remote command: `ROSC:SOUR INT`
 `ROSC:EXT:FREQ <numeric value>`

REFERENCE FREQUENCY

As of firmware version 4.4x, instead of the *REFERENCE INT / EXT* softkey, the firmware provides the *REFERENCE FREQUENCY* softkey. This softkey opens a sub-menu to configure the reference more precisely.

To maintain the setup of a test system, the reference settings do not change if a preset is performed.

REFERENCE INTERNAL / EXTERNAL

Activates the internal or external reference.

If the external reference is selected, you can set the frequency of the external reference with the [REFERENCE FREQUENCY](#) softkey.

Remote command: `ROSC:SOUR EXT`
 `ROSC:SOUR INT`

REFERENCE EXT (INT) Provides a fail-safe if the external reference signals fails for any reason.

The softkey activates the use of an external reference signal. However, if the R&S ESCI detects an unlock due to a missing external reference signal, the reference signal source automatically switches to use the internal reference signal.

Once the R&S ESCI has switched to the internal reference signal it stays with the internal reference. You have to switch back to the external reference signal manually (press REFERENCE EXTERNAL and then activate REFERENCE EXT (INT) again). The current source (internal or external) is indicated in the lower part of the softkey.

Remote command: `ROSC:SOUR EAUT`

REFERENCE FREQUENCY Sets the frequency of the external reference. The range is from 1 MHz to 20 MHz with the default value being 10 MHz.

The reference frequency does not change after a preset to maintain the setup of a test system.

Remote command: `ROSC:EXT:FREQ 10 MHZ`

REF BW (NORM WIDE) Controls the PLL bandwidth used to synchronize with the external reference signal. Possible settings are NORM (PLL bandwidth about 3 Hz) or WIDE (PLL bandwidth about 30 Hz). The default setting is NORM.

The reference settings do not change after a preset to maintain the setup of a test system.

The softkey is available only if the external reference frequency is 10 MHz.



This function requires a certain minimum board revision of the synthesizer board.

Remote command: `ROSC:EXT:PLL NORM | WIDE`

4.7.3.2 Control of V-Networks (LISNs)

LISN The *LISN* softkey opens the submenu including the settings required to control V-networks (LISNs).

ESH2-Z5 / ESH3-Z5 / ENV 4200 / ENV 216 / OFF
--

PHASE N / PHASE L1 / PHASE L2 / PHASE L3
--

PE GROUNDED / PE FLOATING

ESH2-Z5 / ESH3-Z5 / ENV 4200 / ENV 216 / OFF	The <i>ESH2-Z5</i> , <i>ESH3-Z5</i> , <i>ENV 4200</i> , <i>ENV 216</i> and <i>OFF</i> softkeys select the V-network to be controlled via the user port. They are toggle softkeys, and only one of them can be activated at a time.
<i>ESH2-Z5</i>	four-line V-network is controlled.
<i>ESH3-Z5</i>	two-line V-network is controlled.
<i>ENV 4200</i>	four-line V-network is controlled.
<i>ENV 216</i>	two-line V-network is controlled.
<i>OFF</i>	remote control is deactivated.

Remote command: INP:LISN TWOP | FOUR | ENV4200 | ENV216 | OFF

PHASE N / PHASE L1 / PHASE L2 / PHASE L3	The <i>PHASE N</i> , <i>PHASE L1</i> , <i>PHASE L2</i> , and <i>PHASE L3</i> softkeys select the phase of the V-network on which the RFI voltage is to be measured.
<i>PHASE N</i>	RFI on phase N is measured.
<i>PHASE L1</i>	RFI on phase L1 is measured.
<i>PHASE L2</i>	RFI on phase L2 is measured (only for <i>ESH2-Z5/ENV 4200</i>).
<i>PHASE L3</i>	RFI on phase L3 is measured (only for <i>ESH2-Z5/ENV 4200</i>).

Remote command: INP:LISN:PHAS L1|L2|L3|N

150 KHZ HIGHPASS	The <i>150 KHZ HIGHPASS</i> softkey switches an 150 kHz highpass on to protect the receiver input from high signal levels below 150 kHz (only for <i>ENV 216</i>).
---------------------	---

Remote command: INP:LISN:FILT:HPAS ON | OFF

PE GROUNDED / PE FLOATING	The <i>PE GROUNDED</i> and <i>PE FLOATING</i> softkeys switch the protective earth conductor chokes on or off.
<i>PE GROUNDED</i>	Protective earth conductor choke is switched off.
<i>PE FLOATING</i>	Protective earth conductor choke is switched on.

Remote command: INP:LISN:PEAR GRO|FLO

4.7.3.3 Preamplification and Preselection

The R&S ESCI offers a switchable preselector and a switchable preamplifier. The preselection filter is always active in receiver mode.

For the R&S ESCI the 20 dB preamplifier is available only if the preselection is switched on. For the R&S ESCI7, the 20 dB preamplifier can be switched on and off regardless of the preselection setting.

Preselection

The frequency range 9 kHz to 3 GHz is distributed over 11 filter bands.

With the R&S ESCI7, the frequency range 3 GHz to 7 GHz is preselected by a YIG tracking bandpass filter.

Two fixed-tuned filters are used up to 2 MHz, eight tracking passband and high-pass filters from 2 MHz to 2000 MHz and a fixed-tuned high-pass filter above 2 GHz.

The filters are switched by a relay at 150 kHz and by PIN-diode switches above 150 kHz.

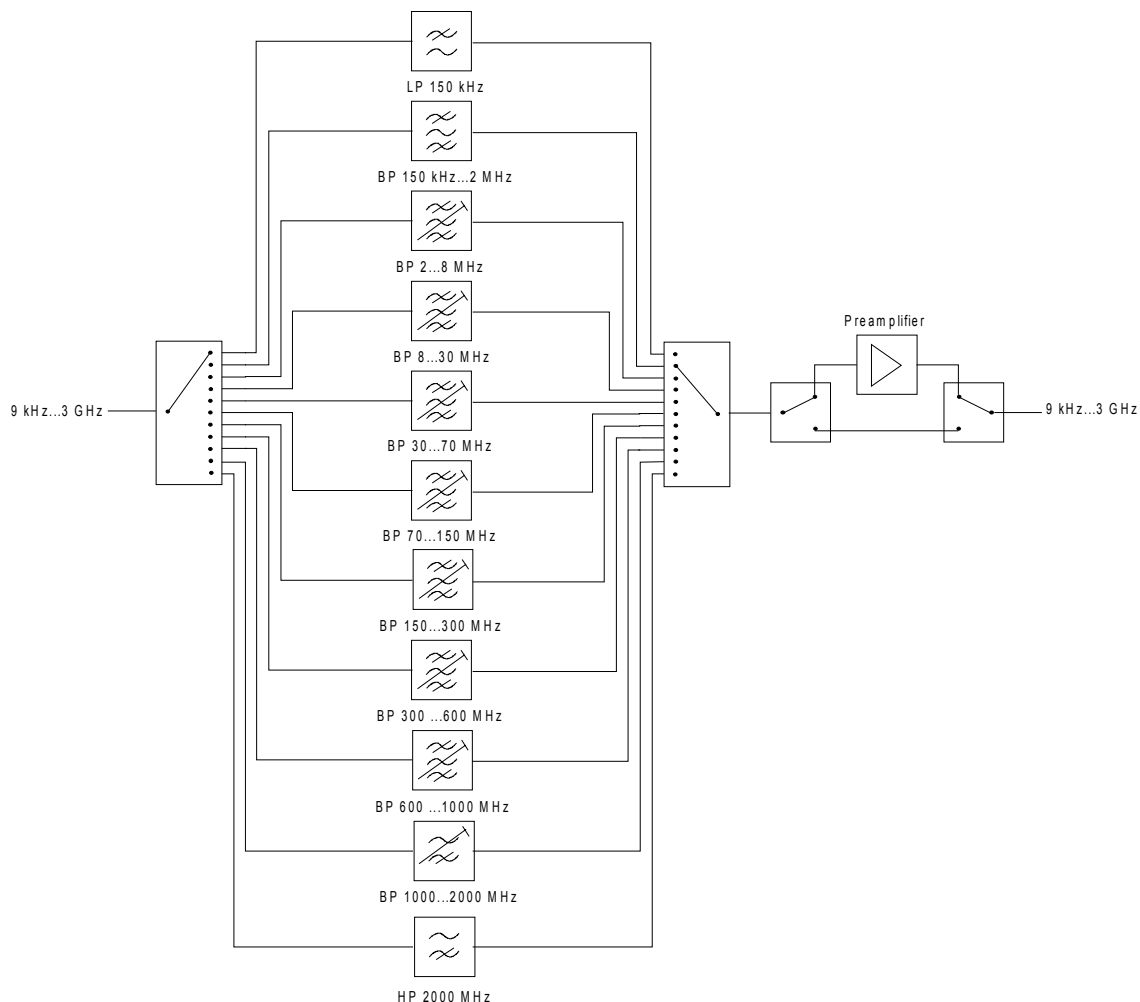

Fig. 4.17 Preselection and preamplifier

PRESELECT ON/OFF

The *PRESELECT ON/OFF* softkey switches the preselection on or off.

The softkey is available only in the analyzer mode.

Remote command: `INP: PRES ON`

Preselection causes additional dependencies which are automatically taken into account in the coupled setting.

- With the preselection active, the FFT bandwidths are not available.
- With the preselection active, the start frequency is set to 150 kHz in the FULL SPAN setting to avoid permanent switching of the relay at the band limit of 150 kHz.
- Due to the limited tuning speed of the tracking passband filters, the maximum sweep rate (3 GHz / 15 ms) can no longer be attained with the preselection switched on. The minimum settable sweep time is obtained from the sum of the minimum possible sweep times in the associated filter bands.

Filter band	Min. sweep time for filter band
9 kHz to 150 kHz	-
150 kHz to 2 MHz	-
2 to 8 MHz	500 ms
8 to 30 MHz	50 ms
30 to 70 MHz	50 ms
70 to 150 MHz	50 ms
150 to 300 MHz	50 ms
300 to 600 MHz	50 ms
600 to 1000 MHz	50 ms
1000 to 2000 MHz	50 ms
2000 to 3000 MHz	-
3000 to 7000 MHz	50 ms

Preamplification

Switching on the preamplifier diminishes the total noise figure of the R&S ESCI, thus increasing the sensitivity. The preamplifier follows the preselection filters so that the risk of overdriving by strong out-of-band signals is reduced to a minimum. The signal level of the subsequent mixer is 20 dB higher so that the maximum input level is reduced by the gain of the preamplifier. The total noise figure of R&S ESCI is reduced from approx. 18 dB to approx. 11 dB with the preamplifier switched on. The use of the preamplifier is recommended when measurements with a maximum sensitivity are to be performed. If the measurement should be performed at maximum dynamic range, the preamplifier should be switched off.

The gain of the preamplifier is automatically considered in the level display. In analyzer mode, on switching on the preamplifier the RF attenuation or the reference level is adapted depending on the settings of the R&S ESCI.

PREAMP ON/ OFF

The *PREAMP ON/OFF* softkey switches the preamplifier on or off.

The softkey is available only in the analyzer mode when the measurement with preselection is activated.

Remote command: `:INP:GAIN ON | OFF`

4.7.3.4 Transducer

A transducer is often connected ahead of R&S ESCI both during the measurement of useful signals and EMI and converts the useful or interference variable such as field strength, current or RFI voltage into a voltage across 50 Ohm.

Transducers such as antennas, probes or current probes mostly have a frequency-dependent transducer factor which can be stored in R&S ESCI and automatically has the correct unit during level measurement.

If a transducer is switched on it is considered as part of the unit during the measurement, i.e. the measured values are displayed in the correct unit and magnitude. When working with two measurement windows, the transducer is always assigned to two windows.

R&S ESCI distinguishes between **transducer factor** and **transducer set**. A transducer factor takes the frequency response of a *single* transfer element, e.g. an antenna into consideration. A transducer set can summarize different transducer factors in several subranges (several transducer factors at the same time), e.g. an antenna, a cable and a diplexer.

A transducer factor consists of max. 50 reference values defined with frequency, transducer factor and the unit. For the measurement between frequency values linear or logarithmic interpolation of the transducer factor can be chosen.

Several factors can be compiled in a transducer set provided that all factors have the same unit or unit "dB". The frequency range covered by a set can be subdivided into max. 10 subranges (each with up to 4 transducer factors) which follow each other without a gap, i.e. the stop frequency of a subrange is the start frequency of the next subrange.

The transducer factors used in a subrange have to fully cover the subrange.

The definition of a transducer set is recommended if different transducers are used in the frequency range to be measured or if a cable attenuation or an amplifier has to be taken into consideration.

If a transducer set is defined during a frequency sweep, the latter can be stopped at the interface between two transducer ranges and the user is asked to exchange the transducer.

The following message informs that the limit has been reached:

TDS Range # reached, CONTINUE / BREAK

it is possible either to continue the sweep by confirming the message (*CONTINUE*) or to switch off the transducer (*BREAK*).

With the automatic switchover of the transducer used, the frequency sweep is not interrupted.

Activating Transducer Factors

The *TRANSDUCER* softkey opens a submenu enabling the user to activate or deactivate defined transducer factors, to generate new transducer factors or to edit existing ones. A table with the transducer factors defined is displayed.

As soon as a transducer is activated, the unit of the transducer is automatically used for all the level settings and outputs. The unit cannot be changed in the *AMPT* menu since the R&S ESCI and the transducer used are regarded as one measuring instrument. Only if the transducer has the unit dB, will the unit originally set on the R&S ESCI be maintained and can be changed.

If a transducer factor is active, the remark TDF appears in the enhancement labels column.

After all transducers have been switched off, the R&S ESCI returns to the unit that was used before a transducer was activated.

In the analyzer mode, an active transducer for a sweep is calculated once in advance for every point displayed and is added to the result of the level measurement during the sweep. If the sweep range changes, the correction values are calculated again. If several measured values are combined, only one value is taken into consideration.

In the receiver mode, the transducer is also calculated for a set scan. The transducer is uniquely calculated for each frequency point and added to the result of the level measurement as the measurement results are stored internally and can be zoomed subsequently.

If the active transducer factor is not defined for the entire sweep range, the values missing are replaced by zeroes.

TRANSDUCER The *TRANSDUCER* softkey opens a submenu for editing existing transducer factors and sets or creating new transducer factors and sets.

TRANSDUCER FACTOR	
TRANSDUCER SET	
NEW / EDIT ↓ (transducer factors)	INSERT LINE
	DELETE LINE
	SAVE TRD FACTOR
NEW / EDIT ↓ (transducer sets)	INS BEFORE RANGE
	INS AFTER RANGE
	DELETE RANGE
	RANGES 1-5/6-10
	SAVE TRD SET
VIEW TRANSDUCER	
REFLVL ADJ AUTO MAN	
PAGE UP	
PAGE DOWN	

Tables show the settings of already existing transducer factors and transducer sets as well as the settings of the active transducer factor or transducer set.

ACTIVE TRANSDUCER FACTOR			
Name:	Cable_1	Freq range:	10 MHz
Unit:	dB	to:	1 GHz
Comment:			

TRANSDUCER FACTOR	
Name	Unit
✓ Cable_1	dB
HK116	dBuV/m
HL223	dBuV/m

TRANSDUCER SET	
Name	Unit
30M-1G	dBuV/m

The *ACTIVE TRANSDUCER FACTOR / SET* table indicates the active transducer factor or the set with the associated name, frequency range and unit. If no factor or set is active, *NONE* is displayed in the table. Additional information can be entered in a comment line. If a transducer factor is active, the selected interpolation is displayed in addition, if a set is active, the break setting is displayed.

The *TRANSDUCER FACTOR* table comprises all the defined factors with name and unit. If the number of defined transducer factors exceeds the number of possible lines in the table, the table will be scrolled.

The *TRANSDUCER SET* table comprises all the defined transducer sets with the corresponding information.

Only one set or transducer can be activated. An already active transducer factor or set is switched off automatically if another one is switched on. An activated transducer factor or set is marked with a check sign.

TRANSDUCER FACTOR The *TRANSDUCER FACTOR* softkey places the scrollbar on the position of the active transducer factor.

If a transducer factor is not active, the scrollbar is placed on the first line of the table.

Remote command: CORR:TRAN:SEL <name>
CORR:TRAN ON | OFF

TRANSDUCER SET The *TRANSDUCER SET* softkey places the scrollbar on the position of the active transducer set. For further details refer to [“Entry and Editing of Transducer Sets” on page 4.242](#).

If no transducer set is switched on, the bar is set to the first line of the table.

Remote command: CORR:TSET:SEL <name>
CORR:TSET ON | OFF

EDIT TRD FACTOR The *EDIT TRD FACTOR* softkey gives access to the submenu for editing and generating transducer factors. For details refer to section [“Entry and Editing of Transducer Factors” on page 4.239](#).

NEW FACTOR The *NEW FACTOR* softkey gives access to the submenu for editing and generating transducer factors. For details refer to section [“Entry and Editing of Transducer Factors” on page 4.239](#).

DELETE The *DELETE* softkey deletes the marked factor or set.
To prevent deletion by mistake, deletion has to be confirmed.

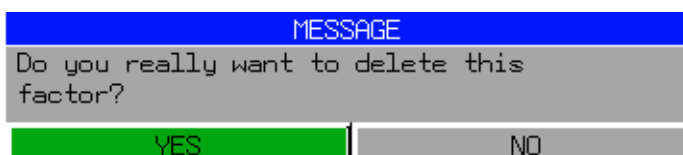

Remote command: CORR:TRAN DEL

VIEW TRANSDUCER The *VIEW TRANSDUCER* softkey activates the display of the active transducer factor or set. During the measurement, the interpolated characteristic of the active transducer factor or set is shown in the diagram instead of the measured values.

Remote command: CORR:TRAN:VIEW ON

**REFLVL ADJ
AUTO MAN** When a transducer factor is used, the trace is moved by a calculated shift. However, an upward shift reduces the dynamic range for the displayed values. With the softkey *REFLVL ADJ* an automatic reference level offset adaptation allows to restore the original dynamic range by also shifting the reference level by the maximum value of the transducer factor.

Remote command: `CORR:TRAN:ADJ:RLEV ON | OFF`



The remote commands `CORR:TRAN:ADJ:RLEV` or `CORR:TRAN:ADJ:RLEV` have to be sent prior to this command.

PAGE UP The *PAGE UP* softkey is used to scroll through large tables that cannot completely be displayed on the screen.

PAGE DOWN The *PAGE DOWN* softkey is used to scroll through large tables that cannot completely be displayed on the screen.

Entry and Editing of Transducer Factors

A transducer factor is characterized by the following:

- Reference values with frequency and factor (*Values*)
- Unit of the factor (*Unit*) and
- Name (*Name*) to distinguish the various factors.

During entry the R&S ESCI checks the transducer factor for compliance with specific rules that must be met to ensure correct operation.

- The frequencies for the reference values must always be entered in ascending order. Otherwise the entry will not be accepted and the following message is displayed:

WRONG FREQUENCY SEQUENCE !

- The frequencies entered may exceed the frequency range of the R&S ESCI since only the set frequency range is taken into account for measurements. The minimum frequency of a reference value is 0 Hz, the maximum frequency 200 GHz.
- The value range for the transducer factor is ± 200 dB. If the minimum or maximum value is exceeded, the R&S ESCI outputs the following message:

out of range

- Gain has to be entered as a negative value, and attenuation as a positive value.



The softkeys in the *UNIT* submenu of the *AMPT* key cannot be operated if the transducer is on.

NEW / EDIT

The submenu differs for transducer factors and transducer sets. The submenu for transducer sets is described in section “[Entry and Editing of Transducer Sets](#)” on [page 4.242](#). In the following, the submenu for transducer factors is described.

The *NEW* and *EDIT* softkeys give access to the submenu for editing and generating transducer factors.

INSERT LINE
DELETE LINE
SAVE TRD FACTOR

EDIT TRANSDUCER FACTOR			
Name/Unit/Interpolation:	Cable	dB	LIN
Comment:			
FREQUENCY	TDF/dB..	FREQUENCY	TDF/dB..
1.0000000 MHz	1.000		
1.0000000 GHz	5.500		

Depending on the softkey selected, either the table with the data of the factor marked (*EDIT TRD FACTOR* softkey) or an empty table (*NEW FACTOR* softkey) is displayed. This table is empty except for the following entries:

Unit: dB
 Interpolation: LIN for linear frequency scaling
 LOG for logarithmic frequency scaling

The features of the factor are entered in the header of the table, and the frequency and the transducer factor are entered in the columns.

Name Entry of name
Unit Selection of unit
Interpolation Selection of interpolation
Comment Entry of comment
FREQUENCY Entry of frequency of reference values
TDF/dB Entry of transducer factor.

During editing, a transducer factor remains stored in the background until the factor edited is saved with the *SAVE TRD FACTOR* softkey or until the table is closed. A factor that was edited by mistake can be restored by leaving the entry function.

Name - Entry of name

A maximum of 8 characters is permissible for the name. The characters have to comply with the convention of DOS file names. If the name exceeds 8 characters, the name is truncated. The unit automatically stores all transducer factors with the extension .TDF. If an existing name is changed, the factor stored under the previous

name is retained and will not be overwritten automatically with the new name. The previous factor can be deleted at a later time, using DELETE. Thus, factors can be copied.

Remote command: `CORR:TRAN:SEL <name>`

Unit – Selection of unit

The unit of the transducer factor is selected from a selection box activated by the ENTER key. The default setting is dB.

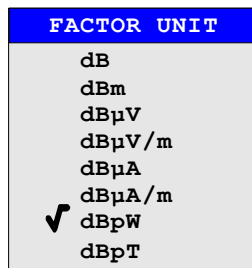

Remote command: `CORR:TRAN:UNIT <string>`

Entry of value

The desired reference values for FREQUENCY and TDF/dB must be entered in ascending order of frequencies. After the frequency has been entered, the scrollbar automatically goes to the associated level value.

The table can be edited after entry of the first value using the *INSERT LINE* and *DELETE LINE* softkeys. To change individual values later on, the value has to be selected and a new one entered.

Remote command: `CORR:TRAN:DATA <freq>,<level>`

Interpolation - Selection of interpolation

Linear or logarithmic interpolation can be performed between the frequency reference values of the table. The *ENTER* key allows the user to select LIN or LOG (toggle function).

Remote command: `CORR:TRAN:SCAL LIN|LOG`

The following diagrams show the effect that interpolation has on the calculated trace:

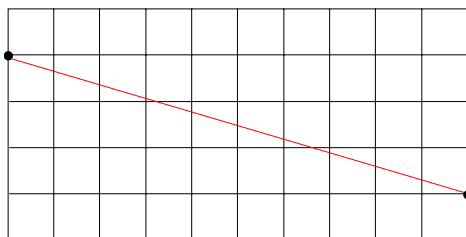

Fig. 4.18 Linear frequency axis and linear interpolation

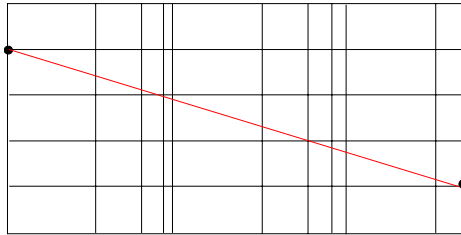

Fig. 4.19 Logarithmic frequency axis and interpolation

Comment - Entry of comment

Any comment with a maximum length of 50 characters can be entered.

Remote command: `CORR:TRAN:COMM <string>`

INSERT LINE The *INSERT LINE* softkey inserts an empty line above the marked reference value. When entering a new reference value in the line, the ascending order of frequencies must be taken into consideration, however.

Remote command: `--`

DELETE LINE The *DELETE LINE* softkey deletes the marked reference value (complete line). The reference values that follow move one line up.

Remote command: `--`

SAVE TRD FACTOR The *SAVE TRD FACTOR* softkey saves the changed table in a file on the internal hard disk.

If there is already a transducer factor that has the same name, a confirmation query is output.

If the new factor is active, the new values become immediately valid.

If a transducer set is switched on comprising the factor, the values will only be used when the set is switched on next time.

Remote command: `--`
(executed automatically after the definition of the reference values)

Entry and Editing of Transducer Sets

A transducer set is characterized by:

- maximum 10 ranges (*Ranges*) in which different transducer factors can be active
- the combination of several transducer factors per range (*Factor*)
- a transducer-set name (*Name*)

NEW / EDIT

INS BEFORE RANGE
INS AFTER RANGE
DELETE RANGE
RANGES 1-5/6-10
SAVE TRD SET

The *NEW* and *EDIT* softkeys both open the submenu for editing and entering new transducer factors if softkey *TRANSDUCER SET* is active.

EDIT TRANSDUCER SET					
Name/Unit/Break				dBuV	OFF
Comment:					
	RANGE1	RANGE2	RANGE3	RANGE4	RANGE5
Start	30 MHz	300 MHz			
Stop	300 MHz	1 GHz			
Factors	Cable Antenna1	Cable Preamp Antenna2			

The table with the data of the marked set (the *EDIT* softkey) or an empty table in which the following entries are preset (the *NEW* softkey) is displayed:

Unit: dB
Break: OFF

The characteristics of the set can be entered in the header field of the table, the sub-ranges in the columns of the set.

Name Entry of the name
Unit Selection of unit
Break Activating the query when changing the subrange
Comment Entry of a comment
Start Entry of the start frequency of the subrange
Stop Entry of the stop frequency of the subrange
Factors Selection of the transducer factors for the subrange

An overwritten transducer set remains stored in the background as long as the edited factor is stored with the *SAVE TRD SET* softkey or until the table is closed. A set overwritten by mistake can be restored by leaving the entry.

Name - Entry of name

A maximum of 8 characters is permissible for the name. The characters have to comply with the convention of DOS file names. If the name exceeds 8 characters, the name is truncated. The unit automatically stores all transducer sets with the extension .TDS.

If an existing name is changed, the set stored under the previous name is retained and will not be overwritten automatically with the new name. The previous set can be deleted at a later time using *DELETE FACTOR/SET*. Thus, sets can be copied.

Remote command: CORR:TSET:SEL <name>

Unit - Selection of unit

The unit of the transducer set is selected from a selection box activated by the ENTER key.

The unit should be selected prior to the entry as it determines the settable transducer factors. The preset unit for new sets is "dB".



Remote command: `CORR:TSET:UNIT <string>`

Break - Activation of query when changing a subrange

The sweep can be stopped if the user changes the subrange and selects a new subrange of the transducer. A message informs the user that the limit has been attained. He can continue the sweep or switch off the transducer.

The interruption is activated by setting Break to ON. Selection is by the ENTER key which toggles between ON and OFF (toggle function).

Remote command: `CORR:TSET:BRE ON|OFF`

Start - Entry of start frequency of subrange

Stop - Entry of stop frequency of subrange

The individual subranges have to be linked without a gap. That is why the start frequency is already defined from the second subrange (= stop frequency of previous range).

Remote command: `CORR:TSET:RANG<1..10>
<freq>,<freq>,<name>..`

INS BEFORE RANGE The *INS BEFORE RANGE* softkey copies the active column and inserts it to the right. The frequency limits can be edited.

Remote command: `--`

INS AFTER RANGE The *INS AFTER RANGE* softkey copies the active column and inserts it to the left. The frequency limits can be edited.

Remote command: `--`

DELETE RANGE The *DELETE RANGE* softkey deletes the marked subrange. The following subranges move left.

Remote command: `--`

RANGES 1-5/6-10 The *RANGES 1-5/6-10* softkey switches between the display of ranges 1 to five and ranges 6 to 10.

Remote command: `--`

Factors - Selection of factors for the subrange

The permissible transducer factors for the marked subrange can be selected in a selection box. Only factors matching with the unit of the set and fully covering the selected subrange are permissible.

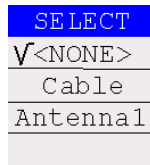

After each change of range limits, R&S ESCI thus checks the factor list and, if required, rebuilds it.

After reducing the start frequency or increasing the stop frequency of a range it may happen that the factors defined for this range no longer fully cover the range. These factors are deleted for this range when the transducer factor table is opened next time.

A maximum of 4 transducer factors can be switched on at the same time in each subrange. If none of them is switched on, 0 dB is assumed as a factor for the whole subrange.

Remote command: --

SAVE TRD SET The *SAVE TRD SET* softkey saves the changed table in a file on the internal hard disk. If a transducer name with the same name already exists, a corresponding query is performed beforehand:

If the saved set is switched on, the new values will be used immediately.

Remote command: -- (executed automatically)

4.7.3.5 Programming the Interface Configuration and Time Setup

The *GENERAL SETUP* softkey opens a submenu in which the general instrument parameters can be set up. In addition to the configuration of the digital interfaces (*IECBUS*, *COM*), the date and time may be entered.

The current settings are displayed in tabular form on the display screen where they may be edited.

GENERAL SETUP

GPIB ↓	GPIB ADDRESS
	ID STRING FACTORY
	ID STRING USER
	GPIB LANGUAGE
	IF GAIN NORM/PULS
	SWEEP REP ON/OFF
	COUPLING FSP/HP
USER PORT ↓	USER PORT IN/OUT
	PORT 0 0/1 to PORT 7 0/1
COM INTERFACE	

TIME+DATE	
CONFIGURE NETWORK	COMPUTER NAME
	IP ADDRESS
	SUBNET MASK
	DHCP ON OFF
	CONFIGURE NETWORK
	SHOW CONFIG
NETWORK LOGIN	
OPTIONS ↓	INSTALL OPTION
	REMOVE OPTION
Side menu	
SOFT FRONTPANEL	

Selecting the GPIB Address

GPIB The *GPIB* softkey opens a submenu for setting the parameters of the remote-control interface.

Remote command: --

GPIB ADDRESS The *GPIB ADDRESS* softkey enables the entry of the GPIB address.

Valid addresses are 0 through 30. The default address is 20.

Remote command: SYST:COMM:GPIB:ADDR 20

ID STRING FACTORY The *ID STRING FACTORY* softkey selects the default response to the *IDN? query.

Remote command: --

ID STRING USER The *ID STRING USER* softkey opens an editor for entering a user-defined response to the *IDN? query.

Max. length of output string: 36 characters

Remote command: --

GPIB LANGUAGE The *GPIB LANGUAGE* softkey opens a list of selectable remote-control languages:

- SCPI
- 71100C
- 71200C
- 71209A
- 8560E
- 8561E
- 8562E

- 8563E
- 8564E
- 8565E
- 8566A
- 8566B
- 8568A
- 8568A_DC
- 8568B
- 8568B_DC
- 8591E
- 8594E



For 8566A/B, 8568A/B and 8594E, command sets A and B are available. Command sets A and B differ in the rules regarding the command structure from the command structure of "SCPI". Therefore, correct recognition of SCPI commands is not ensured in these operating modes.

Selecting a language different from "SCPI" will set the GPIB address to 18 if it was 20 before.

Start / stop frequency, reference level and # of sweep points will be adapted to the selected instrument model.

8568A_DC and 8568B_DC are using DC input coupling as default if it is supported by the instrument.

The HP model 8591E is compatible to HP model 8594E, the HP models 71100C, 71200C, and 71209A are compatible to HP models 8566A/B.

On switching between remote-control languages, the following settings or changes will be made:

SCPI:

- > The instrument will perform a PRESET.

8566A/B, 8568A/B, 8594E:

- > The instrument will perform a PRESET.
- > The following instrument settings will then be changed:

Model	# of Trace Points	Start Freq.	Stop Freq.	Ref Level	Input Coupling
8566A/B	1001	2 GHz	22 GHz	0 dBm	DC
8568A/B	1001	0 Hz	1.5 GHz	0 dBm	AC
8560E	601	0 Hz	2.9 GHz	0 dBm	AC
8561E	601	0 Hz	6.5 GHz	0 dBm	AC
8562E	601	0 Hz	13.2 GHz	0 dBm	AC
8563E	601	0 Hz	26.5 GHz	0 dBm	AC

Model	# of Trace Points	Start Freq.	Stop Freq.	Ref Level	Input Coupling
8564E	601	0 Hz	40 GHz	0 dBm	AC
8565E	601	0 Hz	50 GHz	0 dBm	AC
8594E	401	0 Hz	3 GHz	0 dBm	AC



Notes regarding switch over to 8566A/B and 8568A/B on R&S FSUP

- The stop frequency indicated in the table may be limited to the corresponding frequency of the R&S ESCI, if required.

Remote command: `SYST:LANG "SCPI" | "8560E" | "8561E" | "8562E" | "8563E" | "8564E" | "8565E" | "8566A" | "8566B" | "8568A" | "8568A_DC" | "8568B" | "8568B_DC" | "8591E" | "8594E" | "71100C" | "71200C" | "71209A"`

IF GAIN NORM/
PULS

The *IF GAIN NORM/PULS* softkey configures the internal IF gain settings in HP emulation mode due to the application needs. This setting is only taken into account for resolution bandwidth < 300 kHz.

NORM Optimized for high dynamic range, overload limit is close to reference level.

PULS Optimized for pulsed signals, overload limit up to 10 dB above reference level.

This softkey is only available, if a HP language is selected via the [GPIB LANGUAGE](#) softkey.

Remote command: `SYST:IFG:MODE PULS`

SWEEP REP
ON/OFF

The *SWEEP REP ON/OFF* softkey controls a repeated sweep of the `E1` and `MKPK HI` HP model commands (for details on the commands refer to [“GPIB Commands of HP Models 856xE, 8566A/B, 8568A/B and 8594E” on page 6.258](#)). If the repeated sweep is OFF, the marker is set without sweeping before.



In single sweep mode, switch off this softkey before you set the marker via the `E1` and `MKPK HI` commands in order to avoid sweeping afresh.

This softkey is only available, if a HP language is selected via the [GPIB LANGUAGE](#) softkey.

Remote command: `SYST:RSW ON`

COUPLING FSP/HP The *COUPLING FSP/HP* softkey controls the default coupling ratios for:

- span and resolution bandwidth (Span/RBW) and
- resolution bandwidth and video bandwidth (RBW/VBW)

for the HP emulation mode.

In case of FSP the standard parameter coupling of the instrument is used. As a result in most cases a shorter sweeptime is used than in case of HP.

The softkey is only available in HP emulation mode.

Remote command: `SYST:HPC FSP`

User Port Configuration

The instrument provides a parallel interface, which is 8 bits wide. Over these ports, arbitrary bit patterns can be output or input.

USER PORT

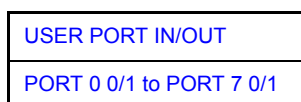

The *USER PORT* softkey opens the submenu for setting the direction of the data transmission and for entering the values of the individual ports.

USER PORT IN/OUT

The *USER PORT IN/OUT* determines in which direction the interface transmits data.

USER PORT (read operation)

The value is indicated in a window. A new readout is started by pressing *READ*. Pressing *OK* closes the window

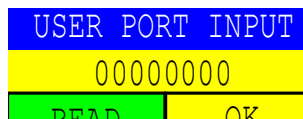

Remote command: `INP:UPOR:STAT ON`
`INP:UPOR?`

USER PORT OUT (write operation)

The bit pattern selected with softkeys *PORT 0* to *PORT 7* is output.

Remote command: `OUTP:UPOR:STAT ON`

PORT 0 0/1 to PORT 7 0/1

The *PORT 0 0/1* to *PORT 7 0/1* softkeys determine the output value for port 1 to 7. These softkeys are only available for setting *USER PORT OUT*.

Remote command: `OUTP:UPOR STAT ON`
`OUTP:UPOR #B10110010`

Serial Interface Configuration

COM INTERFACE

The *COM INTERFACE* softkey activates the *COM INTERFACE* table for entry of the serial interface parameters.

The following parameters can be configured in the table:

<i>Baud rate</i>	data transmission rate
<i>Bits</i>	number of data bits
<i>Parity</i>	bit parity check
<i>Stop bits</i>	number of stop bits
<i>HW-Handshake</i>	hardware handshake protocol
<i>SW-Handshake</i>	software handshake protocol
<i>Owner</i>	assignment to the measuring instrument or computer

COM INTERFACE	
Baud	9600
Bits	8
Parity	NONE
Stopbits	2
HW-Handshake	NONE
SW-Handshake	NONE
Owner	INSTRUMENT

Baud – Data transmission rate

The R&S ESCI supports baud rates between 110 and 128000 baud. The default setting is 9600 baud.

BAUD RATE
128000
115200
57600
38400
19200
✓9600
4800
2400
1200
600
300
110

Remote command: `SYST:COMM:SER:BAUD 9600`

Bits – Number of data bits per word

For the transmission of text without special characters, 7 bits are adequate. For binary data as well as for text with special characters, 8 bits must be selected (default setting).

BITS
7
✓8

Remote command: `SYST:COMM:SER:BITS 7`

Parity – Bit parity check

NONE no parity check (default setting)
 EVEN even parity check
 ODD odd parity check



Remote command: `SYST:COMM:SER:PAR NONE`

Stop bits – Number of stop bits

Available are 1 and 2. The default setting is 1 stop bit.



Remote command: `SYST:COMM:SER:SBIT 1`

HW-Handshake – Hardware handshake protocol

The integrity of data transmission can be improved by the use of a hardware handshake mechanism, which effectively prevents uncontrolled transmission of data and the resulting loss of data bytes. For hardware handshake additional interface lines are used to transmit acknowledge signals with which the data transmission can be controlled and, if necessary, stopped until the receiver is ready to receive data again.

A prerequisite for using hardware handshaking is, however, that the interface lines (DTR and RTS) are connected on both transmitter and receiver. For a simple 3-wire connection, this is not the case and hardware handshake cannot be used here.

Default setting is *NONE*.



Remote command: `SYST:COMM:SER:CONT:DTR OFF`
`SYST:COMM:SER:CONT:RTS OFF`

SW-Handshake – Software handshake protocol

Besides the hardware handshake mechanism using interface lines, it is also possible to achieve the same effect by using a software handshake protocol. Here, control bytes are transmitted in addition to the normal data bytes. These control bytes can be used, as necessary, to stop data transmission until the receiver is ready to receive data again.

In contrast to hardware handshaking, software handshaking can be realized even for a simple 3-wire connection.

One limitation is, however, that software handshaking cannot be used for the transmission of binary data, since the control characters XON and XOFF require bit combinations that are also used for binary data transmission.

Default setting is *NONE*.



Remote command: `SYST:COMM:SER:PACE NONE`

Owner – Assignment of the interface

The serial interface can be assigned alternatively to the measuring instrument section or to the computer section.

If the interface is assigned to one section of the instrument, it is not available to the other section.

INSTRUMENT The interface is assigned to the measuring instrument section.

Outputs to the interface from the computer section are not possible and will get lost.

OS The interface is assigned to the computer section. It cannot be used by the measuring instrument section. This means that remote control of the instrument via the interface is not possible.



Setting Date and Time

TIME+DATE

The *TIME+DATE* softkey activates the entry of time and date for the internal real-time clock.

Time - Input of time

In the corresponding dialog box, the time is partitioned into two input fields so that hours and minutes can be entered independently.

Remote command: `SYST:TIME 21,59`

Date - Input of Date

In the corresponding dialog box, the date is partitioned into 3 input fields so that day, month and year can be input separately.

For the selection of the month, pressing a unit key opens a list of abbreviations wherein the desired month can be selected.

Remote command: `SYST:DATE 1009,03,01`

Configuration of Network Settings

The instrument can be connected to an Ethernet LAN (local area network) by means of the LAN Interface. This allows data transmission via the network and the use of network printers. The network card is able to handle both 10 MHz Ethernet IEEE 802.3 and 100 MHz Ethernet IEEE 802.3u.

For more details see the Quick Start Guide 6, "[LAN Interface](#)".

CONFIGURE NETWORK

The *CONFIGURE NETWORK* softkey opens the following submenu:

COMPUTER NAME
IP ADDRESS
SUBNET MASK
DHCP ON OFF
CONFIGURE NETWORK
SHOW CONFIG



The Network Configuration softkeys above are available from firmware Version 4.3x.

Instruments shipped with Windows XP Service Pack1 require an additional installation package (LXI installer) if the softkeys are not visible. This installation package is available on the R&S instrument's download area.

The configuration via softkeys is only possible if the LAN is connected to the instrument.

COMPUTER NAME

The *COMPUTERNAME* softkey opens a dialog to enter the computer name. The naming conventions of Windows apply.

For more details see the Quick Start Guide 6, "[LAN Interface](#)".

IP ADDRESS

The *IP ADDRESS* softkey opens a dialog to configure the instrument's IP address. The TCP/IP protocol is preinstalled with the IP address 10.0.0.10. If the DHCP server is available (DHCP ON) the softkey is not available.

For more details see the Quick Start Guide 6, "[LAN Interface](#)".

SUBNET MASK

The *SUBNET MASK* softkey opens a dialog to configure the instrument's TCP/IP subnet mask. The TCP/IP protocol is preinstalled with the subnet mask 255.255.255.0.

The subnet mask consists of four number blocks separated by dots. Each block contain 3 numbers in maximum (e.g.100.100.100.100), but also one or two numbers are allowed in a block (as an example see the preinstalled address).

For more details see the Quick Start Guide 6, "[LAN Interface](#)".

DHCP ON | OFF

If the *DHCP* softkey is set ON, a new IP address is assigned each time the instrument is restarted. This address must first be determined on the instrument itself.



To avoid problems, use a fixed IP address.

Using a DHCP server is not suitable for remote operation of the R&S FSU.

CONFIGURE NETWORK

The *CONFIGURE NETWORK* softkey opens the dialog box with the network settings.

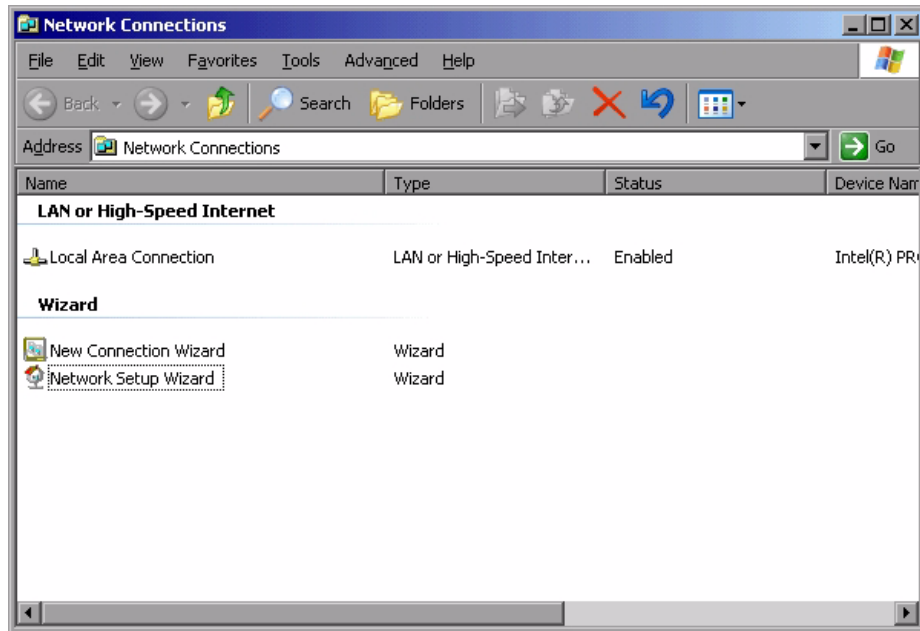

The softkey is used to modify an existing network configuration after the corresponding tabs are selected (see the Quick Start Guide 6, “LAN Interface”).



A PC keyboard with trackball (or mouse instead) is required for the installation/configuration of the network support.

The softkey is only available with built-in LAN interface R&S FSP-B16.

Remote command: --

SHOW CONFIG The *SHOW CONFIG* softkey shows the current network configuration.

NETWORK ADAPTER – CONFIGURATION	
DHCP	ON
COMPUTER NAME	MYINSTRUMENT
IP ADDRESS	10.114.10.235
NETMASK	255.255.0.0

NETWORK LOGIN

The *NETWORK LOGIN* softkey opens the dialog box with the auto login settings.

Important:

The password was changed to '123456' with firmware version 4.5. For version < 4.5, the password is 'instrument'.

When a network is installed, the preset user name 'instrument' and the password '123456' can be adapted to a new user (see the Quick Start Guide 6, “LAN Interface”).

With the 'Auto Login' option active, an automatic registration is performed during booting with the specified user name and password. Otherwise the Windows XP login request is displayed during booting.

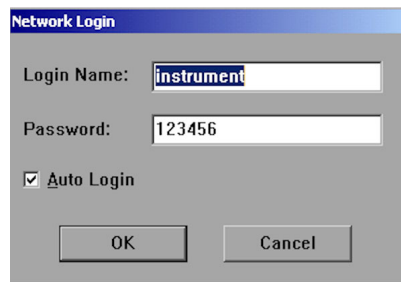

A PC keyboard with trackball (or mouse instead) is required for the installation/configuration of the network support.

For information on deactivating/activating the auto login mechanism see section "Logging on to the Network" in chapter 'LAN Interface' of the Quick Start Guide.

Remote command: --

Enabling Firmware Options

The *OPTIONS* softkey opens a submenu that allows license keys for firmware options to be entered. Previously installed options are displayed in a table that opens automatically.

Remote command: *OPT?

OPTIONS

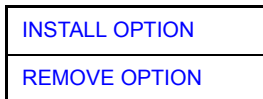

INSTALL OPTION The *INSTALL OPTION* softkey opens the data entry for the license keycode of a firmware option.

On entry of a valid license key the message *OPTION KEY OK* is displayed in the status line and the firmware option appears in table *FIRMWARE OPTIONS*.

On entry of an invalid license key the message *OPTION KEY INVALID* is displayed in the status line.

Remote command: --

REMOVE OPTION The *REMOVE OPTION* softkey removes all firmware options from the instruments. Execution of this function must be confirmed in a message box in order to avoid removal of the firmware options by mistake.

Remote command: --

Emulation of the Instrument Front Panel

SOFT FRONTPANEL

The *SOFT FRONTPANEL* softkey switches the display of the front panel keys on and off.

When the front-panel keys are displayed on the screen, the instrument can be controlled by clicking the respective button with the mouse. This is especially useful when the instrument in a different site is controlled via a remote-control program,

such as, for instance, the remote desktop of Windows XP, and the screen contents are transferred to the controller via remote link (see the Quick Start Guide 6, "LAN Interface").

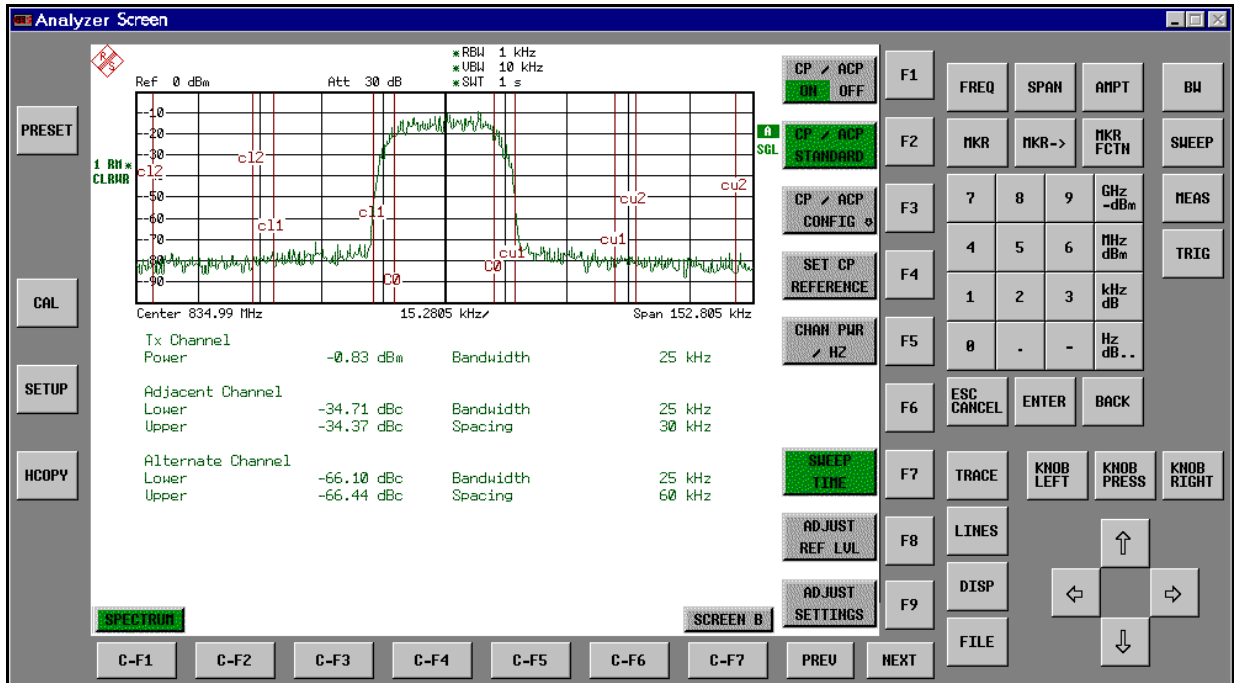

Display resolution

When the display of the front-panel keys is switched on, the screen resolution of the instrument changes to 1024x768 pixels. Only a section of the total screen is then displayed on the LC display, which will automatically be shifted on mouse moves.

In order to obtain a complete display of the user interface, an external monitor is to be plugged into the corresponding connector at the rear panel. Prior to performing the resolution change the user is prompted for confirmation whether the required monitor is connected.

Switching off the front-panel display restores the original screen resolution.

Key assignment

Button labels largely correspond to those of the front-panel keys. The rotation function of the rotary knob is assigned to the 'KNOB LEFT' and 'KNOB RIGHT' buttons, the press function (<ENTER>) to 'KNOB PRESS'.

The labels of the softkey buttons (F1 to F9) and of the hotkey buttons (C-F1 to C-F7) indicate that the keys can be operated directly by means of the corresponding function keys F1 to F9 or <CTRL>F1 to <CTRL>F7 of a PS/2 keyboard.

Remote command: SYST:DISP:FPAN ON

4.7.3.6 System Information

The *SYSTEM INFO* softkey opens a submenu in which detailed information on module data, device statistics and system messages is displayed.

SYSTEM INFO

HARDWARE INFO
STATISTICS
SYSTEM MESSAGES
CLEAR ALL MESSAGES

Display of Module Data

HARDWARE INFO The *HARDWARE INFO* softkey opens a table in which the modules (INSTALLED COMPONENTS) installed in the instrument are listed together with the corresponding hardware revisions.

Table *HARDWARE INFO* consists of six columns:

SERIAL #	serial number
COMPONENT	name of module
ORDER #	order number
MODEL	model number of the module
REV	main modification index of the module
SUB REV	secondary modification index of the module

HARDWARE INFO						
COMPONENT	SERIAL #	ORDER #	MODEL	HWC	REV	SUB REV
STDFRONTEND1	000291/072	0000.0001		23	24	03 44
Frontend2	509038/041	1093.5791		02	00	04 01
IF-FILTER/REF	000000	1093.7242		02	00	01 00
DETECTOR1	000291/072	1093.6998		03	02	03 44
PRESELECT_EMI	100486/002	1093.7120		02	00	03 01
MWC_40_UNIT	000291/072	1093.8584		40	00	03 44
TRACKGEN	000000	1093.7371		02	01	00 00
OCXD	000291/072	0000.0001		23	24	03 44
AF_DEMOD	000121/212	1093.7620		02	00	01 00
EXT MIXER	000291/072	1157.1126		02	00	03 44
MOTHERBOARD	123456/999	1093.7494		02	00	00 00
MWC_40_GS	000000	0000.0000		00	00	00 00
MWC_40_GS	000000	1093.8610		40	00	00 00
DIPLEXER	000000	1151.3010		01	00	00 00
VIG-FILTER	000000	1093.8726		40	00	00 00
RF-EXTENSION	000000	1151.2508		40	00	00 00
ESCI	123456/999	1166.5950		07	00	00 00
TU +RFTRIGGER	000000	1129.8642		02	00	00 00
MBCALIBRATOR	000100/011	1154.7100		02	00	01 28
MWcTempSensor	000000	0000.0000		00	00	00 00
RF-ATTEN_3.6	101850/001	1137.0682		02	00	00 00
NRP-Z21	123456	1137.6000		00	00	00 00



The screenshot lists the components of an R&S ESCI.

Display of Device Statistics

STATISTICS

The *STATISTICS* softkey opens the table *STATISTICS*. This table contains the model information, serial number, firmware version, and specifications version of the basic device. Additionally, the operating time of the instrument, the power-on cycles as well as attenuator switching cycles are displayed.

For new delivered devices the specifications version (document of the hardware properties) is shown. For already delivered device dashes (---) are displayed.

FIRMWARE VERSIONS - STATISTICS	
Model	ESCI-40
Serial #	123456/999
Firmware Rev.	4.22 CP014
BIOS Rev.	47.11
Specifications Version	---
Memory Size	2048 MB
Operating Time (hours)	0
Power On Cycles	0
Attenuator Cycles	
Input RF/Cal	1
5dB	1
10dB	0
20dB	1
40dB	1
AC/DC	1
Preselector Cycles	
Bypass	0
PreAmp	0
150 kHz Switch	0

Remote command: --

Display of System Messages

SYSTEM MESSAGES

The *SYSTEM MESSAGES* softkey opens a submenu including a table in which the generated system messages are displayed in the order of their occurrence. The most recent messages are placed at the top of the list.

The following information is available:

No	Device-specific error code
MESSAGE	Brief description of the message
COMPONENT	On hardware messages: name of the affected module On software messages: if needed, the name of the affected software components
DATE/TIME	Date and time of the occurrence of the message

Messages that have occurred since the last call to the *SYSTEM MESSAGES* menu are marked with an asterisk '*'.

The *CLEAR ALL MESSAGES* softkey is activated and allows clearing of the error buffer.

If the number of error messages exceeds the capacity of the error buffer, the message appearing first is "Message buffer overflow".

SYSTEM MESSAGES			
NO	MESSAGE	COMP.	DATE/TIME
107	Reference is Unlocked	DCON	07.MAR.02; 14:03:19
110	Error 110 size of block too big. Block id 10616	CDS	07.MAR.02; 10:38:45
110	Checksum error RF attenuator Block id 10616	CDS	07.MAR.02; 10:38:45

Remote command: SYST:ERR?

CLEAR ALL MESSAGES

The *CLEAR ALL MESSAGES* softkey deletes all messages in the table.

The softkey is only available when table *SYSTEM INFO* is active.

Remote command: SYST:ERR?

4.7.3.7 Service Menu

The service menu offers a variety of additional functions which are used for maintenance and/or trouble shooting.

NOTICE

The service functions are not necessary for normal measurement operation. However, incorrect use can affect correct operation and/or data integrity of the R&S ESCI.

Therefore, many of the functions can only be used after entering a password. They are described in the instrument service manual.

SERVICE

INPUT RF
INPUT CAL
SELFTEST
SELFTEST RESULTS
ENTER PASSWORD
Side menu
CAL GEN 128 MHZ
PULSE 10 kHz / PULSE 100 kHz / PULSE 200 kHz / PULSE 500 kHz / PULSE 1 MHz / PULSE 2 MHz / PULSE 4 MHz / PULSE 8 MHz /
Side menu
COMMAND TRACKING

The *SERVICE* softkey opens a submenu for selection of the service function.

The *INPUT RF* and *INPUT CAL* softkeys are mutually exclusive selection switches. Only one switch can be active at any one time.

General Service Functions

INPUT RF	<p>The <i>INPUT RF</i> softkey switches the input of the R&S ESCI to the input connector (normal position).</p> <p>After <i>PRESET</i>, <i>RECALL</i> or R&S ESCI power on, the <i>INPUT RF</i> is always selected.</p> <p>Remote command: <code>DIAG:SERV:INP RF</code></p>
INPUT CAL	<p>The <i>INPUT CAL</i> softkey switches the RF input of the R&S ESCI to the internal calibration source (128 MHz) and activates the data entry of the output level of the calibration source. Possible values are 0 dB and -30 dB.</p> <p>Remote command: <code>DIAG:SERV:INP CAL;</code> <code>DIAG:SERV:INP:CSO 0 DBM</code></p>
ENTER PASSWORD	<p>The <i>ENTER PASSWORD</i> softkey allows the entry of a password.</p> <p>The R&S ESCI contains a variety of service functions which, if incorrectly used, can affect correct operation of the R&S ESCI. These functions are normally not accessible and are only usable after the entry of a password (see instrument service manual).</p> <p>Remote command: <code>SYST:PASS "Password"</code></p>
CAL GEN 128 MHZ	<p>The <i>CAL GEN 128 MHZ</i> softkey selects a sinusoidal signal at 128 MHz as output signal for the internal calibration source. The internal pulse generator will be switched off.</p> <p>CAL GEN 128 MHZ is the default setting of the R&S ESCI.</p> <p>Remote command: <code>DIAG:SERV:INP CAL</code> <code>DIAG:SERV:INP:PULS OFF</code></p> <p>This softkey switches the internal pulse generator on and allows the pulse frequency to be entered.</p> <p>Remote command: <code>DIAG:SERV:INP:PULS ON;</code> <code>DIAG:SERV:INP:PULS:PRAT <value></code></p>
PULSE 10 kHz / PULSE 100 kHz /PULSE 200 kHz /PULSE 500 kHz /PULSE 1 MHz / PULSE 2 MHz / PULSE 4 MHz / PULSE 8 MHz /	<p>The <i>PULSE xx</i> softkey switches the selected pulse generator on.</p> <p>Remote command: <code>DIAG:SERV:INP CAL</code> <code>DIAG:SERV:INP:PULS ON;</code> <code>DIAG:SERV:INP:PULS:PRAT 2 MHZ</code></p>
COMMAND TRACKING	<p>The <i>COMMAND TRACKING</i> softkey activates or deactivates the SCPI error log function. All remote control commands received by the R&S ESCI are recorded in the following log file: <code>D:\R_S\instr\log\IEC_CMDS.LOG</code></p> <p>Logging the commands may be extremely useful for debug purposes, e.g. in order to find misspelled keywords in control programs.</p>



If this softkey is activated, the R&S ESCI becomes slower.

Remote command: --

Selftest

SELFTEST The *SELFTEST* softkey initiates the selftest of the instrument modules.

With this function the instrument is capable of identifying a defective module in case of failure.

During the selftest a message box appears in which the current test and its result is shown. The test sequence can be aborted by pressing ENTER ABORT.

All modules are checked consecutively and the test result (selftest PASSED or FAILED) is output in the message box.

Remote command: *TST?

SELFTEST RESULTS The *SELFTEST RESULTS* softkey calls the *SELFTEST* table in which the results of the module test are displayed.

In case of failure a short description of the failed test, the defective module, the associated value range and the corresponding test results are indicated.

SELFTEST RESULTS				
Total Selftest Status: user mode ---PASSED---				
Rohde&Schwarz,ESCI-40.123456/999.4.22				
Date (dd/mm/yyyy): 24/03/2006 Time: 14:27:26				
Runtime: 01:06				
Supply voltages wideband Detector [Volt]				
test description	min	max	result	state
+6V	5.50	6.60	6.16	PASSED
+8V	7.60	9.20	8.26	PASSED
+12V	11.39	13.20	12.32	PASSED
-12V	-14.27	-10.45	-12.47	PASSED
-5V	-5.97	-4.06	-5.04	PASSED
-6V	-7.18	-4.86	-6.21	PASSED
Supply & ref. voltages IF-Filter [Volt]				
test description	min	max	result	state
TEMPERATURE	0.20	70.20	39.80	PASSED
-5VREF	-5.30	-4.70	-5.00	PASSED

Remote command: DIAG:SERV:STE:RES?

PAGE UP / PAGE DOWN The *PAGE UP* or *PAGE DOWN* softkey sets the *SELFTEST RESULTS* table to the next or previous page.

Remote command: --

Hardware Adjustment

Some of the R&S ESCI modules can be realigned. This realignment can become necessary after calibration due to temperature drift or aging of components (see service manual instrument).

NOTICE

The realignment should be carried out by qualified personnel since the changes considerably influence the measurement accuracy of the instrument. This is the reason why the softkeys *REF FREQUENCY*, *CAL SIGNAL POWER* and *SAVE CHANGES* can only be accessed after entering a password.

4.7.3.8 Firmware Update

For the latest firmware version refer to the Rohde & Schwarz internet site and download the most up-to-date firmware.

A detailed description about performing the firmware update in the instrument is given in the release note, provided on this CD. The release note is also downloadable from the Rohde & Schwarz internet site.

The installation of a new firmware version can be performed using a memory stick or the built-in disk drive.

The installation program is called in the *SETUP* menu.

FIRMWARE UPDATE

FIRMWARE UPDATE
RESTORE FIRMWARE
UPDATE PATH

The *FIRMWARE UPDATE* softkey opens the subdirectory for installing/deinstalling new firmware versions.

Remote command: --

FIRMWARE UPDATE The *FIRMWARE UPDATE* softkey starts the installation program and leads the user through the remaining steps of the update.

Remote command: "SYST:FIRM:UPD 'D:\USER\FWUPDATE'"

RESTORE FIRMWARE The *RESTORE FIRMWARE* softkey restores the previous firmware version

Remote command: --

UPDATE PATH The *UPDATE PATH* softkey is used to select the drive and directories under which the archive files for the firmware update are stored.

The firmware update can thus also be performed via network drives or USB memory sticks/USB-CD-ROM drives.

Remote command: "SYST:FIRM:UPD 'D:\USER\FWUPDATE'"

APPL SETUP RECOVERY

The *APPL SETUP RECOVERY* (Application Setup Recovery) softkey controls the instrument behaviour when changing the active application, e.g from *SPECTRUM* to *FM DEMOD* and back from *FM DEMOD* to *SPECTRUM*.

In the default state *OFF* a few parameters of the current analyzer setting are passed to the application (e.g. center frequency, level settings) or from the application back to the analyzer mode.

If *APPL SETUP RECOVERY* is switched *ON*, the settings of the applications are independent of each other. Leaving the *FM DEMOD* application will restore the previous state of the *ANALYZER*.



The individual application settings are stored on the internal harddisk.

Remote command: `SYST:APPL:SREC ON`

4.7.3.9 External Noise Source**NOISE SRC ON/OFF**

The *NOISE SRC ON/OFF* softkey switches on or off the supply voltage for an external noise source which is connected to the *NOISE SOURCE* connector on the rear panel of the instrument.

Remote command: `DIAG:SERV:NSO ON`

PRESET RECEIVER

The *RECEIVER PRESET* softkey sets the receiver mode as preset mode. Default state is the receiver mode.

Remote command: `SYST:PRES:COMP OFF`

PRESET ANALYZER

The *ANALYZER PRESET* softkey sets the analyzer mode as preset mode.

The analyzer mode is compatible with the settings of R&S ESCI EMI Test Receiver and R&S FSU Spectrum Analyzer. It facilitates programming of control software for several instrument types.

Remote command: `SYST:PRES:COMP FSP`

OPEN START MENU

Opens the windows XP start menu and therefore provides an easy access to standard windows functions if a mouse is connect.

4.7.4 Saving and Recalling Data Sets – FILE Key

4.7.4.1 Overview

The *FILE* key calls the following functions:

- Storage/loading functions for storing (*SAVE*) instrument settings such as instrument configurations (measurement/display settings, etc.) and measurement results from working memory to permanent storage media, or to load (*RECALL*) stored data into working memory.
- Functions for management of storage media (*FILE MANAGER*). Included are among others functions for listing files, formatting storage media, copying, and deleting/renaming files.

The R&S ESCI is capable of internally storing complete instrument settings with instrument configurations and measurement data in the form of data sets. The respective data are stored on the internal hard disk or, if selected, on a memory stick or on a floppy. The hard disk and floppy disk drives have the following names:

floppy disk A:, hard disk D: (hard disk C: is reserved for instrument software)

FILE

SAVE RECALL ↓	SAVE FILE	
	RECALL FILE	
	SELECT PATH	
	SELECT FILE	
	EDIT FILE NAME	
	EDIT COMMENT	
	SELECT ITEMS ↓	SELECT ITEMS
		ENABLE ALL ITEMS
		DISABLE ALL ITEMS
	DELETE FILE	
	NEW FOLDER	
STARTUP RECALL		
FILE MANAGER ↓	EDIT PATH	
	NEW FOLDER	
	PASTE	
	SORT MODE ↓	NAME
		DATE
		EXTENSION
		SIZE
	2 FILE LISTS	
	Side menu	
	FORMAT DISK	

For details on storing and loading instrument settings refer to the Quick Start Guide, chapter “[Storing and Loading Instrument Settings](#)”.

SAVE | RECALL

The *SAVE* softkey opens the Save dialog box for entering the data set to be stored.

The *RECALL* softkey activates the Recall dialog box to enter the data set to be loaded. The *RECALL* table shows the current settings regarding the data set.

The entries are edited with the rotary knob or the *CURSOR UP / DOWN* key and is confirmed by pressing the rotary knob or the *ENTER* key.

Subdirectories are opened by the *CURSOR RIGHT*  key and closed with the *CURSOR LEFT*  key.

In the Save dialog box, the field already contains a suggestion for a new name: the file name used in the last saving process is counted up to the next unused name. For example, if the name last used was "test_004", the new name "test_005" is suggested, but only if this name is not in use. If the name "test_005" is already in use, the next free name is suggested, e.g. "test_006". You can change the suggested name to any name conform to the following naming conventions.

The name of a settings file consists of a base name followed by an underscore and three numbers, e.g. "limit_lines_005". In the example, the base name is "limit_lines". The base name can contain characters, numbers and underscores. The file extension is added automatically and can not be changed.

The *SAVE / RECALL* table contains the entry fields for editing the data set.

Path Directory in which the data set is stored.

Files List of data sets already stored.

File Name Name of data set.

The name can be entered with or without drive name and directory; the drive name and directory, if available, will then appear in the Path field. The extension of the data name is ignored.

Comment Comment regarding the data set.

Items Selection of settings to be stored/loaded.

Remote command: `M MEM:STOR:STAT 1,"a:\test02"`
`M MEM:LOAD:STAT 1,"a:\test02"`

SAVE FILE	The <i>SAVE FILE</i> softkey sets the focus on the File Name field to enter a conforming file name.
RECALL FILE	The <i>RECALL FILE</i> softkey sets the focus on the Files field to choose a stored file to restore.
SELECT PATH	The <i>SELECT PATH</i> softkey sets the focus on the Path field and opens the pull-down list to choose the correct path to store the file.
SELECT FILE	The <i>SELECT FILE</i> softkey sets the focus on the Files field to choose a already stored file. In addition, the <i>DELETE</i> softkey is displayed. The list Files lists all data sets which are stored in the selected directory.
	Remote command: --

- EDIT FILE NAME** The *EDIT FILE NAME* softkey sets the focus on the File Name field and.
- In the Save dialog box, the field already contains a suggestion for a new name: the file name used in the last saving process is counted up to the next unused name. For example, if the name last used was "test_004", the new name "test_005" is suggested, but only if this name is not in use. If the name "test_005" is already in use, the next free name is suggested, e.g. "test_006". You can change the suggested name to any name conform to the following naming conventions.
- The name of a settings file consists of a base name followed by an underscore and three numbers, e.g. "limit_lines_005". In the example, the base name is "limit_lines". The base name can contain characters, numbers and underscores. The file extension is added automatically and can not be changed.
- EDIT COMMENT** The *EDIT COMMENT* softkey activates the entry of commentary concerning the current data set. The focus is set on the Comment field and an on-screen keyboard opens.



For further information on how to enter the comment text via the front panel of the unit, see the Quick Start Guide, chapter 4, "Basic Operation".

Remote command: `M MEM:COMM "Setup for FM measurement"`

- SELECT ITEMS** The *SELECT ITEMS* softkey moves the selection bar to the first line, left column of the *Items* field. An entry is selected. Position the entry focus to the corresponding partial data set using the cursor keys and then press the *ENTER* key in the desired line. The selection is cleared by pressing the key again.

The following submenu is opened:

SELECT ITEMS
ENABLE ALL ITEMS
DISABLE ALL ITEMS

Remote command: `M MEM:SEL:HWS ON (Current Settings)`
`M MEM:SEL:LIN:ALL ON (All Limit Lines)`
`M MEM:SEL:TRAC ON (All Traces)`
`M MEM:SEL:SCD ON (Source Cal Data)`
`M MEM:SEL:TRAN:ALL ON (All Transducers)`
`M MEM:SEL:FIN ON (Peak/Final List)`
`M MEM:SEL:CLIST ON (Scan Channel List)`

Note that the command `M MEM:SEL:SCD ON (Source Cal Data)` is only available with option R&S ESCI-B09 or R&S ESCI-B10.

The *Save* dialog box offers the following selectable data subsets in the *Items* field.

<i>Current Settings</i>	<p>These settings include:</p> <ul style="list-style-type: none"> • current configuration of general instrument parameters • current measurement hardware settings • active limit lines: <ul style="list-style-type: none"> A data set may contain maximum 8 limit lines for each window. It always contain the activated limit lines and the de-activated limit lines used last, if any. Consequently, the combination of the restored deactivated limit lines depends on the sequence of use with command <code>MMEM:LOAD</code>. • the activated transducer factor • user-defined color settings • configuration for hardcopy output • active transducer set: <ul style="list-style-type: none"> A data set may contain maximum 4 transducer factors. It always contain the activated factors and the factors used and de-activated last, if any. Consequently, the combination of the restored deactivated transducer factors depends on the sequence of use with the command <code>MMEM:LOAD</code>. • peak list or final measurement results (receiver mode) • settings of tracking generator (only with option R&S ESCI B9)
<i>All Limit Lines</i>	all limit lines
<i>All Transducer</i>	all transducer factors
<i>All Transducers</i>	all transducer
<i>All Traces</i>	all traces which are not blanked
<i>Source Cal Data</i>	correction data for tracking generator (only with options R&S ESCI B9 or R&S ESCI B10)
<i>Scan Channel List</i>	adds the channel lists to the list of data subsets of a save/recall device setting. (only with option R&S ESCI K50)
<i>Peak-Final List</i>	peak list or final measurement results

SELECT ITEMS	The <i>SELECT ITEMS</i> softkey sets the focus on the <i>Items</i> field to select the appropriate item to be stored.
ENABLE ALL ITEMS	<p>The <i>ENABLE ALL ITEMS</i> softkey marks all partial data sets.</p> <p>Remote command: <code>MMEM:SEL:ALL</code></p>
DISABLE ALL ITEMS	<p>The <i>DISABLE ALL ITEMS</i> softkey deselects all partial data sets.</p> <p>Remote command: <code>MMEM:SEL:NONE</code></p>

DELETE FILE The *DELETE FILE* softkey sets the focus on the File Name field to enter the file name to be deleted. Alternatively the file to be deleted can be chosen from the Files list. A message box opens to confirm the deletion.

Remote command: `MMEM:DEL "test03"`

NEW FOLDER The *NEW FOLDER* softkey opens an on-screen keyboard to enter a new folder name.

DEFAULT CONFIG The *DEFAULT CONFIG* softkey establishes the default selection of the data subset to be saved and outputs *DEFAULT* in the *ITEMS* field of the *SAVE/RECALL DATA SET* table.

Remote command: `MMEM:SEL:DEF`

STARTUP RECALL

The *STARTUP RECALL* softkey activates the selection of a data set which is automatically loaded when the instrument is powered on and after *PRESET*. For this purpose the Dialog *Startup Recall* is opened (analogously to *DATA SET LIST*).

The field *Files* lists all data sets stored in the selected directory. The currently selected data set is checked.

In addition to the data sets stored by the user, the data set *FACTORY*, which specifies the settings of the instrument before it was last switched off (Standby), is always present (when unit is delivered).

To select a data set, the entry focus is set to the corresponding entry by means of the rotary knob and the data set is activated by pressing the rotary knob or the *ENTER* key.

If a data set other than *FACTORY* is chosen, this data set will be loaded when the unit is switched on or after pressing the *PRESET* key. Any settings can be assigned to the *PRESET* key.

Remote command: `MMEM:LOAD:AUTO 1, "D:\user\config\test02"`

4.7.4.2 Operating Concept of File Managers

FILE MANAGER

The *FILE MANAGER* softkey opens a menu for managing storage media and files.

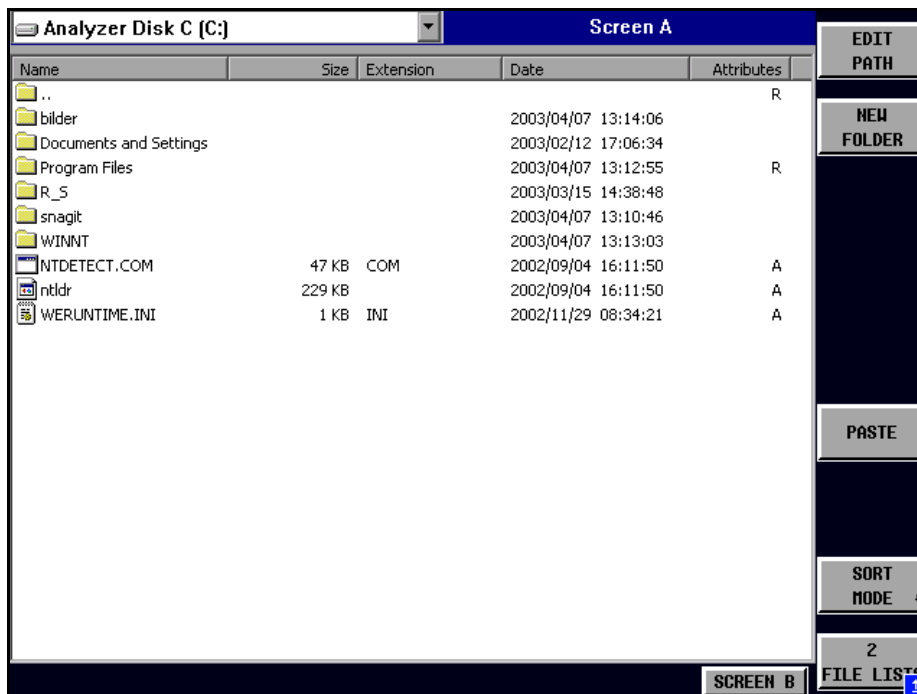

The designation and the letter of the current drive are displayed in the upper left corner of the File Manager dialog.

The table below shows the files of the current directory and potential subdirectories.

A file or a directory in the table is selected via cursor keys. The *ENTER* key is used to switch from one subdirectory to another. The softkeys *COPY*, *RENAME*, *CUT* and *DELETE* are only visible if the entry focus is set to a file and not to a directory.

The dots ".." open up the next higher directory.

EDIT PATH The *EDIT PATH* softkey activates the input of the directory which will be used in subsequent file operations.

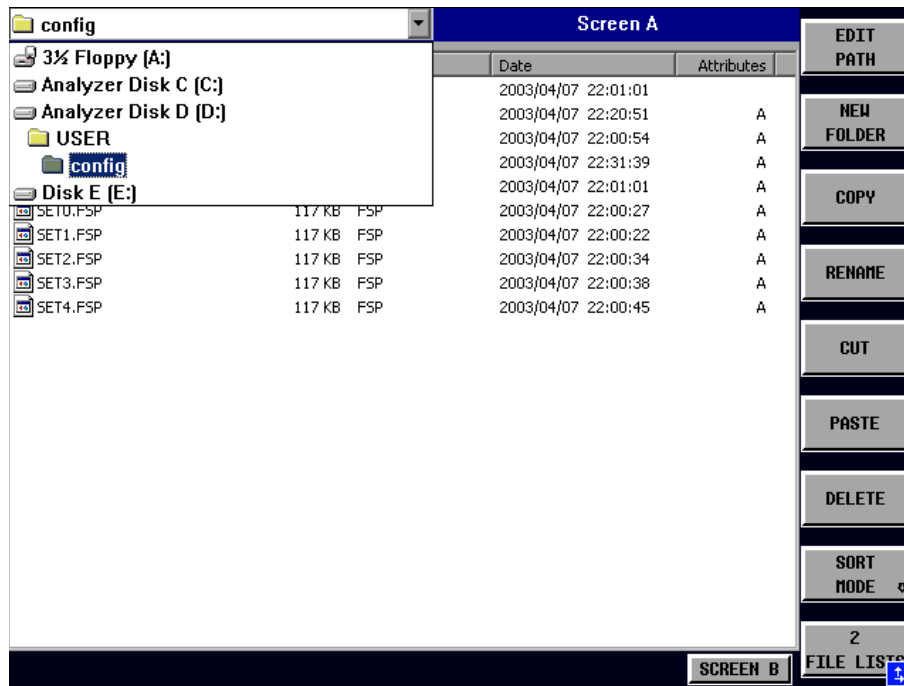

Use CURSOR UP / DOWN to select a drive and confirm your selection with ENTER.

Open subdirectories by using CURSOR RIGHT, and use CURSOR LEFT to close them again.

When you have found the subdirectory you looked for, mark it with ENTER.

```
Remote command:      MMEM:MSIS "a:"
                    MMEM:CDIR "D:\user "
```

NEW FOLDER The *NEW FOLDER* softkey creates subdirectories.

The entry of an absolute path name (e.g. "\USER\MEAS") as well as the path relative to the current directory (e.g. "..\MEAS") is possible.

```
Remote command:      MMEM:MDIR "D:\user\test"
```

- COPY** The *COPY* softkey opens the help line editor to enter the target directory for a copying process. The file is also copied into the clipboard and can be copied into a different directory at a later time by means of *PASTE*.

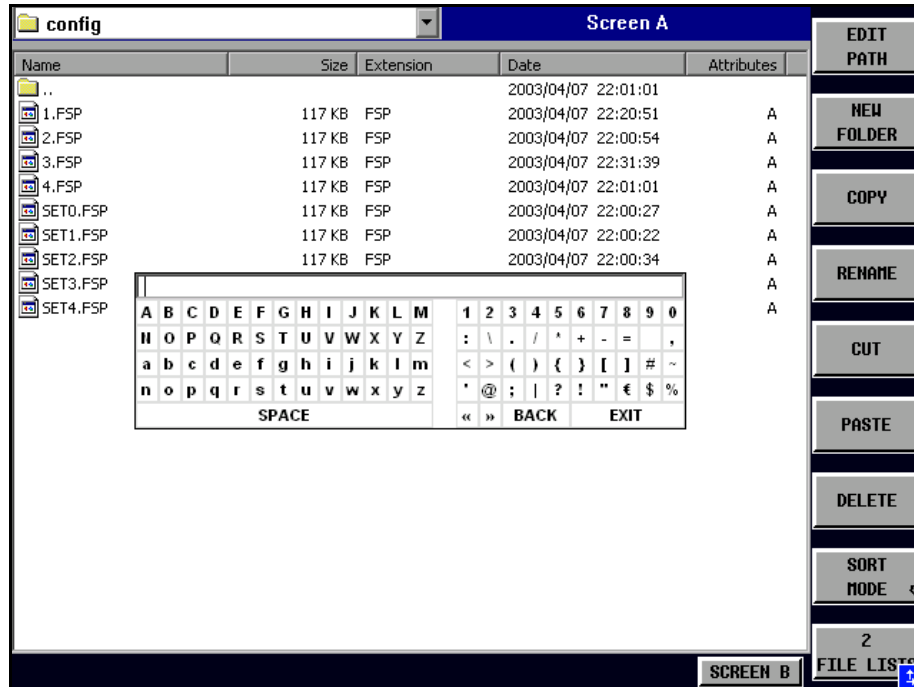

Files can also be copied to a different storage medium by indicating a certain drive letter (e.g. D:). The selected files or directories will be copied after terminating the entry with the ENTER key.

Remote command: `MMEM:COPY "D:\user\set.cfg", "a:"`

- RENAME** The *RENAME* softkey opens the help line editor to rename a file or a directory (analogously to the *COPY* softkey).

Remote command: `MMEM:MOVE "test02.cfg", "set2.cfg"`

- CUT** The *CUT* softkey shifts the selected file into the clipboard from where it can be copied into a different directory at a later time by means of *PASTE*.



The file in the output directory will only be deleted if the *PASTE* softkey has been pressed.

Remote command: `--`

- PASTE** The *PASTE* softkey copies files from the clipboard to the current directory. The directory is changed by means of the cursor keys and subsequent pressing of *ENTER* or via the *EDIT PATH* softkey.

Remote command: `--`

DELETE The *DELETE* softkey deletes the selected file.

A confirmation query is displayed to avoid unintentional deletion of files.

Remote command: MMEM:DEL "test01.hcp"
 MMEM:RDIR "D:\user\test"

SORT MODE

NAME
DATE
EXTENSION
SIZE

The *SORT MODE* softkey opens the submenu to select the sorting mode for the displayed files.



Directory names are located at the top of the list after the entry for the next higher directory level ("..").

Remote command: --

NAME The *NAME* softkey sorts the file list by name.

Remote command: --

DATE The *DATE* softkey sorts the file list by date.

Remote command: --

EXTENSION The *EXTENSION* softkey sorts the file list by file extension.

Remote command: --

SIZE The *SIZE* softkey sorts the file list by size

Remote command: --

2 FILE LISTS The *2 FILE LISTS* softkey opens a second window for the File Manager. The entry focus can be moved between the two windows by means of *SCREEN A* and *SCREEN B* hotkeys. Files can thus very easily be copied and shifted from one directory to the other.



The second file list can also be opened in the Full Screen mode via *SCREEN B* or *SCREEN A* hotkey.

Remote command: -

FORMAT DISK The *FORMAT DISK* softkey formats disks located in drive A:.

To prevent accidental destruction of disk data, confirmation by the user is requested.

Remote command: MMEM:INIT "a:"

4.7.5 Measurement Documentation – HCOPIY Key

The *HCOPIY* key opens the *HARDCOPY* menu for starting and configuring the print-out. The installation and configuration of printers is described in the Quick Start Guide chapters 2, “Preparing for Use”, 6, “LAN Interface” and appendix A

HCOPIY

PRINT SCREEN		
PRINT TRACE		
PRINT TABLE		
DEVICE SETUP		
DEVICE 1 / 2		
COLORS ↓	COLOR ON/OFF	
	SCREEN COLORS	
	OPTIMIZED COLOR SET	
	USER DEFINED ↓	SELECT OBJECT
		BRIGHTNESS
		TINT
		SATURATION
		PREDEFINED COLORS
		SET TO DEFAULT
COMMENT		
Side menu		
INSTALL PRINTER		

Pressing one of the softkeys *PRINT SCREEN*, *PRINT TRACE* or *PRINT TABLE* in the *HCOPY* menu initiates the print job. The printer parameters defined in the *DEVICE SETTINGS* menu are used for setting up the printer configuration. All of the display items to be printed are written to the printer buffer. Since the printer runs in the background, the instrument may be operated immediately after pressing the *PRINT* softkey.

With *PRINT SCREEN* selected, all the diagrams with traces and status displays are printed as they occur on the screen. Softkeys, open tables and data entry fields are not printed.

The *PRINT TRACE* function allows individual traces to be printed. With *PRINT TABLE*, tables can be printed.

The *DEVICE 1 / 2* softkeys are used for selecting and configuring the output interface. For detailed information refer to “[DEVICE 1 / 2](#)” on page 4.275.

If the *Print to File* option in the *Hardcopy Setup* dialog box is selected, the printout is directed to a file. Upon pressing one of the *PRINT...* softkeys, the file name to which the output data is to be written is requested. An entry field is then opened for entering the file name. For detailed information refer to section “[DEVICE SETUP](#)” on page 4.275.

The *COLORS* submenu allows switch over between black-and-white and color printouts (default), provided that the printer connected can produce color printouts. In addition, the colors are set in this submenu. For detailed information refer to section “[Selecting Printer Colors](#)” on page 4.276.

- *SCREEN* Output in screen colors.
- *OPTIMIZED* (default) Instead of light colors, dark colors are used for traces and markers: trace 1 blue, trace 1 black, trace 3 green, markers turquoise.
- *USER DEFINED* This option enables the user to change the colors at will. It provides the same setting functions as the *DISPLAY – CONFIG DISPLAY – NEXT* menu.



- With *SCREEN* and *OPTIMIZED* selected, the background will always be white and the grid black. With *USER DEFINED*, these colors can be selected, too.
- Upon activation of the submenu, the color display is switched over to the selected printout colors. When the menu is quit, the original color setting is restored.

The *COMMENT SCREEN A / B* softkeys allow text to be added to the printout (date and time are inserted automatically).

Use the *INSTALL PRINTER* softkey to install additional printer drivers.

PRINT SCREEN

The *PRINT SCREEN* softkey starts the output of test results.

All the diagrams, traces, markers, marker lists, limit lines etc. are printed out as long as they are displayed on the screen. All the softkeys, tables and open data entry fields are not printed out. Moreover, comments, title, date, and time are output at the bottom margin of the printout.

Remote command: *HCOP:ITEM:ALL*
 HCOP:IMM

- PRINT TRACE** The *PRINT TRACE* softkey starts the output of all curves visible on the display screen without auxiliary information. Specifically, no markers or display lines are printed.
- Remote command: HCOP:ITEM:WIND:TRAC:STAT ON
 HCOP:IMM
- PRINT TABLE** The *PRINT TABLE* softkey starts the output of all tables and info lists visible on the display screen without the measurement diagrams and other information lying behind.
- Remote command: HCOP:ITEM:WIND:TABL:STAT ON
 HCOP:IMM
- DEVICE SETUP** The *DEVICE SETUP* softkey opens the dialog where the file format and the printer can be selected. For details on selecting and configuring printers, and printing out the measurement results refer to the Quick Start Guide chapter 2, “[Preparing for Use](#)” and chapter “[Printing Out the Measurement Results](#)”.
- Remote command: HCOP:DEV:LANG GDI;
 SYST:COMM:PRIN:ENUM:FIRS?;
 SYST:COMM:PRIN:ENUM:NEXT?;
 SYST:COMM:PRIN:SEL <Printer>;
 HCOP:PAGE:ORI PORT;
 HCOP:DEST "SYST:COMM:PRIN";
 HCOP:DEST "SYST:COMM:M MEM"
- DEVICE 1 / 2** The R&S ESCI is able to manage two hardcopy settings independently of each other. They are selected via the *DEVICE 1 / 2* softkey, which displays also the associated setting if the *DEVICE SETUP* dialog is open. For details on selecting and configuring printers, and printing out the measurement results refer to the Quick Start Guide chapter 2, “[Preparing for Use](#)” and chapter “[Printing Out the Measurement Results](#)”.
- Remote command: --
- COLORS** The *COLORS* softkey gives access to the submenu where the colors for the printout can be selected (see section “[Selecting Printer Colors](#)” on page 4.276).
- Remote command: --
- COMMENT** The *COMMENT* softkey opens an entry field in which a comment of two lines (60 characters per line) can be entered for screen A or B.
- If the user enters more than 60 characters, the excess characters appear on the second line on the print-out. At any point, a manual line-feed can be forced by entering the @ character.
- The comment is printed below the diagram area. The comment text appears on the hardcopy, but not on the display screen.
- If a comment should not be printed, it must be cleared.
- If the instrument is reset by a click on the PRESET key, all entered comments are cleared.



The *COMMENT* softkey opens the auxiliary line editor where the desired letters can be entered in the text field by means of rotary knob and cursor keys.

After clicking the *COMMENT* softkey, the auxiliary line editor can be reached with the  key. Pressing the rotary knob or the *ENTER* key inserts the selected characters in the text line.

After editing is completed, return to the text line with the  key and confirm the comment text with *ENTER*.

If the entered comment should be aborted, quit the auxiliary line editor with *ESC*.



Only after the auxiliary line editor has been closed with *ESC* can the softkeys and hardkeys be operated again.

A detailed description of the auxiliary line editor can be found in the Quick Start Guide, chapter 4, "Basic Operation".

Remote command: `HCOP:ITEM:WIND2:TEXT 'Comment'`

INSTALL PRINTER

A certain number of printer drivers is already installed on the R&S ESCI.

The *INSTALL PRINTER* softkey opens the *Printers and Faxes* dialog where more printer drivers can be installed.

For details refer to the Quick Start Guide, appendix A.

Remote command: `--`

4.7.5.1 Selecting Printer Colors

COLORS

COLOR ON/OFF	
SCREEN COLORS	
OPTIMIZED COLOR SET	
USER DEFINED ↓	SELECT OBJECT
	BRIGHTNESS
	TINT
	SATURATION
	PREDEFINED COLORS
	SET TO DEFAULT

The *COLORS* softkey gives access to the submenu where the colors for the printout can be selected. To facilitate color selection, the selected color combination is displayed when the menu is entered. The previous colors are restored when the menu is exited.

For details on selecting and configuring printers, and printing out the measurement results refer to the Quick Start Guide chapter 2, "Preparing for Use" and chapter "Printing Out the Measurement Results".

Remote command: --

**COLOR ON/
OFF** The *COLOR ON/OFF* softkey switches over from color output to black-and-white output. All color-highlighted areas are printed in white and all color lines in black. This improves the contrast on the printout. The default setting is COLOR ON.

Remote command: HCOP:DEV:COL ON

**SCREEN
COLORS** The *SCREEN COLORS* softkey selects the current screen colors for the printout.



The background is always printed in white and the grid in black.

Remote command: HCOP:CMAP:DEF1

**OPTIMIZED
COLOR SET** The *OPTIMIZED COLOR SET* softkey selects an optimized color setting for the printout to improve the visibility of the colors on the hardcopy.

Trace 1 is blue, trace 2 black, trace 3 green, and the markers are turquoise.

The other colors correspond to the display colors of the *DISP – CONFIG DISPLAY – DEFAULT COLORS 1* softkey.



The background is always printed in white and the grid in black.

Remote command: HCOP:CMAP:DEF2

USER DEFINED The *USER DEFINED* softkey opens a submenu for user-defined color selection (see submenu *USER DEFINED COLORS*).

Remote command: HCOP:CMAP:DEF3

SELECT OBJECT The *SELECT OBJECT* softkey allows picture elements to be selected to change their color setting. After selection, the *PREDEFINED COLORS*, *BRIGHTNESS*, *TINT* and *SATURATION* softkeys enable the user to change the colors or brightness, the hue and the color saturation of the element selected.

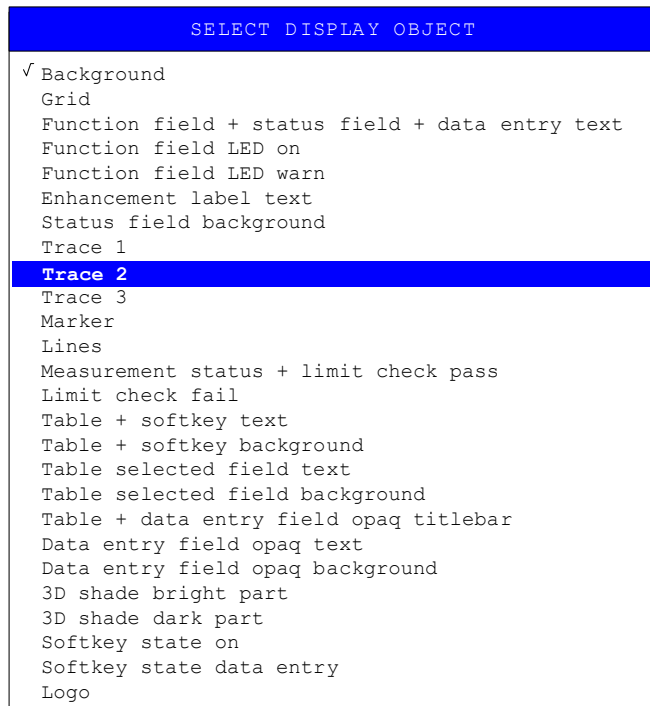

Remote command: --

BRIGHTNESS The *BRIGHTNESS* softkey serves for determining the brightness of the graphic element selected.

A value between 0 and 100% can be entered.

Remote command: HCOP:CMAP5:HSL <hue>,<sat>,<lum>

TINT The *TINT* softkey serves for determining the hue of the element selected. The percentage entered refers to a continuous color spectrum from red (0%) to blue (100%).

Remote command: HCOP:CMAP5:HSL <hue>,<sat>,<lum>

SATURATION The *SATURATION* softkey serves for determining the saturation of the element selected.

A value between 0 and 100% can be entered.

Remote command: HCOP:CMAP5:HSL <hue>,<sat>,<lum>

PREDEFINED COLORS The *PREDEFINED COLORS* softkey opens a list from which predefined colors for the displayed elements can be selected:

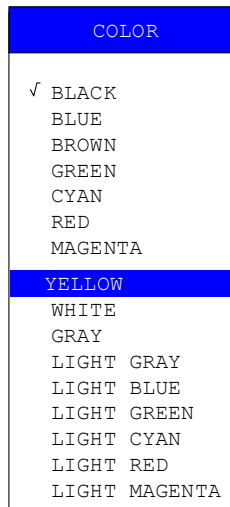

Remote command: `HCOP:CMAP1 ... 26:PDEF <color>`

SET TO DEFAULT The *SET TO DEFAULT* softkey reactivates the default color setting (= *OPTIMIZED COLOR SET*).

Remote command: `--`

4.8 TV and RF Trigger – Option R&S FSP-B6

The option TV and RF Trigger, R&S FSP-B6, enables the R&S ESCI to trigger on TV signals or on the presence of a RF carrier outside the resolution bandwidth.

For this purpose, the hardware board is equipped with a TV demodulator, which produces the trigger signals necessary for the analysis of TV signals. In addition to the pure trigger function, the board also creates a demodulated CCVS video signal for operation of external TV monitors. Apart from using the internal IF for creating the trigger signals, the R&S ESCI can also make use of an externally supplied CCVS signal; the corresponding connector is placed at the rear panel of the instrument.

In order to display different sections of a TV video signal, the R&S ESCI derives several trigger signals from the video signals. This allows triggering as well on the frame repetition as on each line of the TV video signal.

Additionally, the option includes a broadband RF detector (bandwidth = 12 MHz), which allows triggering within a 6 MHz range around the selected frequency (= start frequency in the frequency sweep). Thus, the measurement of spurious emissions, e.g. for pulsed carriers, is possible even when the carrier lies outside the selected frequency span. This RF power trigger can be used as long as the RF signal at the input mixer is in the range of -10 dBm to -50 dBm. The resulting range for the input signal at the RF input connector can be calculated using the following formula:

$$\text{MixerLevel}_{\min} + \text{RFAtt} - \text{PreampGain} \leq \text{InputSignal} \leq \text{MixerLevel}_{\max} + \text{RFAtt} - \text{PreampGain}$$

The RF Power Trigger can be selected and configured in the *TRIGGER* menu (TRIG) using the softkey *RF POWER*:

RF POWER

The *RF POWER* softkey activates triggering of the measurement via signals which are outside the measurement channel.

For this purpose the instrument uses a level detector at the first intermediate frequency. The detector threshold can be selected in a range between -50 dBm and -10 dBm at the input mixer. The resulting trigger level at the RF input is calculated via the following formula:

$$\text{MixerLevel}_{\min} + \text{RFAtt} - \text{PreampGain} \leq \text{InputSignal} \leq \text{MixerLevel}_{\max} + \text{RFAtt} - \text{PreampGain}$$

The bandwidth at the intermediate frequency is 12 MHz. The instrument is triggered as soon as the trigger threshold is exceeded within a 6 MHz range around the selected frequency (= start frequency in the frequency sweep). Thus, the measurement of spurious emissions, e.g. for pulsed carriers, is possible even when the carrier lies outside the selected frequency span.

Remote command: TRIG:SOUR RFP
 SWE:EGAT:SOUR RFP

The configuration menu for TV trigger settings can be reached with key sequence *TRIG – NEXT – TV TRIG SETTINGS*. The *TRIG* menu is described in section “[Triggering the Sweep – TRIG Key](#)” on page 4.93.

TRIG

<i>TRIG</i> side menu	
TV TRIG SETTINGS ↓	TV TRIGGER ON/OFF
	VERT SYNC
	VERT SYNC ODD FIELD / VERT SYNC EVEN FIELD
	HOR SYNC
	VIDEO POL POS / NEG
	LINES 625 / 525
	CCVS INT / EXT

**TV TRIG
SETTINGS**

The *TV TRIG SETTINGS* softkey switches the TV trigger on and opens a submenu for configuration of the TV signal parameters.



Triggering on TV signals is only possible in time domain (span = 0 Hz). Therefore the softkey *TV TRIG SETTINGS* is without function in frequency domain.

Remote command: TRIG:SOUR TV

TV TRIGGER ON/OFF The *TV TRIGGER ON/OFF* softkey switches the TV Trigger on or off. When switching off the TV trigger the selected trigger source will be *FREE RUN*.

Remote command: SENS:TV ON | OFF

VERT SYNC The *VERT SYNC* softkey configures the trigger for the vertical sync signal. The R&S ESCI triggers on the frame repetition without distinction between the two fields.

Remote command: TRIG:VID:FIEL:SEL ALL

VERT SYNC ODD FIELD / VERT SYNC EVEN FIELD The softkeys *VERT SYNC ODD FIELD* and *VERT SYNC EVEN FIELD* configure the trigger for the vertical sync signal of the first or second field.

Remote command: TRIG:VID:FIEL:SEL EVEN | ODD

HOR SYNC The *HOR SYNC* softkey configures the trigger for the horizontal sync signal and opens the data entry field for selection of the corresponding line.

The trigger can be set on any line number, which can be in the range of 1 to 525 or 1 to 625, depending on the line system. The maximum possible line number will be selected if the active range is exceeded.

In order to trigger on test line 17 according to CCIR 473-4, for example, the line value has to be set to 17. This is the default setting after switching on the TV trigger.

Remote command: TRIG:VID:LINE:NUM 17

- VIDEO POL POS / NEG** The *VIDEO POL POS / NEG* softkey selects the polarity of the video signal. Positive video polarity is to be selected e.g. for standard L signals, negative video polarity for signals according to the standards B/G/I/M (colour standard PAL or NTSC). Default setting is VIDEO POL NEG.
- Remote command: TRIG:VID:SSIG:POL NEG
- LINES 625 / 525** The *LINES 625 / 525* softkey selects the line system currently in use. Default setting is 625 *LINES*.
- Remote command: TRIG:VID:FORM:LPFR 625
- CCVS INT / EXT** The *CCVS INT / EXT* softkey selects the input channel for the TV trigger input signal. An external CCVS signal can be supplied via the corresponding connector at the rear panel of the instrument.
- Remote command: SENS:TV:CCVS INT

4.9 Tracking Generator – Option R&S FSP-B9

During normal operation (without a frequency offset), the tracking generator emits a signal exactly at the input frequency of the R&S ESCI.

For frequency-converting measurements it is possible to set a constant frequency offset of ± 150 MHz between the receive frequency of the R&S ESCI and the output signal of the tracking generator.

Moreover, an I/Q modulation or AM and FM modulation of the output signal can be provided using two analog input signals.

The output power is level-controlled and can be set in 0.1 dB steps in a range from -30 dBm to 0 dBm.

The tracking generator can be used in all operating modes. Acquisition of test setup calibration values (SOURCE CAL) and normalization using these correction values (NORMALIZE) is only possible in the *NETWORK* operating mode.



The RF characteristics of some DUTs is especially sensitive concerning the input VSWR. In such cases insertion of 20 dB attenuation between the DUT and the tracking generator output is highly recommended.

The tracking generator is activated by means of the *NETWORK* hotkey in the hotkey bar at the bottom of the screen (for details refer to section [“Mode Selection – Hotkey Bar”](#) on page 4.9.)

4.9.1 Tracking Generator Settings

The *NETWORK* hotkey opens a menu for selecting the functions of the tracking generator.

NETWORK

SOURCE ON/OFF	
SOURCE POWER	
POWER OFFSET	
SOURCE CAL ↓	CAL TRANS
	CAL REFL SHORT
	CAL REFL OPEN
	NORMALIZE
	REF VALUE POSITION
	REF VALUE
	RECALL
	SAVE AS TRD FACTOR
FREQUENCY OFFSET	

MODULATION	EXT AM
	EXT FM
	EXT I/Q
	MODULATION OFF
POWER SWEEP	POWER SWP ON/OFF
	START POWER
	STOP POWER



Additional softkeys are available in the displayed menus for controlling an external generator if option External Generator Control R&S FSP-B10 is fitted. For detailed information see section [“External Generator Control – Option R&S FSP-B10”](#) on page 4.297.

SOURCE ON/ OFF

The *SOURCE ON/OFF* softkey switches the tracking generator on or off. Default setting is *OFF*



- When the tracking generator is switched on the maximum stop frequency is limited to 3 GHz. This upper limit is automatically reduced by a frequency offset set up for the tracking generator.
- In order to meet the data sheet accuracy for measurements with active tracing generator the start frequency must be set to $\geq 3 \times$ Resolution Bandwidth.
- The minimum sweeptime for measurements with data sheet accuracy is 100 ms in frequency domain (span > 0 Hz). Selecting a sweeptime below this limit will result in the sweeptime indicator field SWT being supplied with a red asterisk and the message UNCAL being displayed.
- FFT filters (*FILTER TYPE FFT* in *BW* menu) are not available when the tracking generator is active.

Remote command: `OUTP:STAT ON`

SOURCE POWER

The *SOURCE POWER* softkey allows the tracking generator output power to be selected.

The output power can be set in 0.1 dB steps from -30 dBm to 0 dBm.

If the tracking generator is off, it is automatically switched on when an output power value is entered.

The default output power is -20 dBm.

Remote command: `SOUR:POW -20dBm`

POWER OFFSET

The *POWER OFFSET* softkey allows selection of a constant level offset for the tracking generator.

With this offset for example attenuators or amplifiers at the output connector of the tracking generator can be taken into account for the displayed output power values on screen or during data entry.

The permissible setting range is -200 dB to +200 dB in steps of 0.1 dB. Positive offsets apply to an amplifier and negative offsets to an attenuator subsequent to the tracking generator.

The default setting is 0 dB. Offsets $\neq 0$ are marked by the activated enhancement label *LVL*.

Remote command: `SOUR:POW:OFFS -10dB`

4.9.2 Transmission Measurement

This measurement will yield the transmission characteristics of a two-port network. The built-in tracking generator serves as a signal source. It is connected to the input connector of the DUT. The input of the R&S ESCI is fed from the output of the DUT.

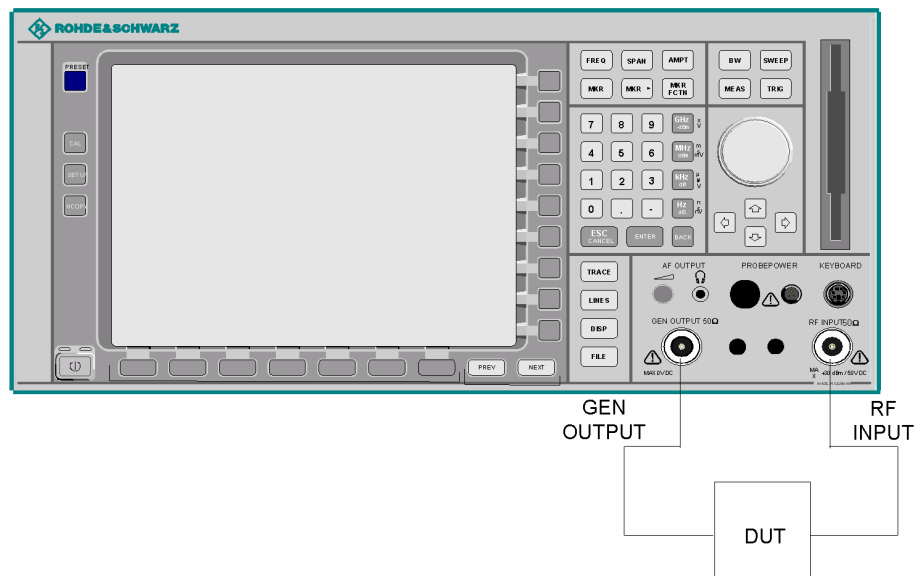

Fig. 4.20 Test setup for transmission measurement

A calibration can be carried out to compensate for the effects of the test setup (e.g. frequency response of connecting cables).

4.9.2.1 Calibration of Transmission Measurement

SOURCE CAL

CAL TRANS
CAL REFL SHORT
CAL REFL OPEN
NORMALIZE
REF VALUE POSITION
REF VALUE
RECALL
SAVE AS TRD FACTOR

The *SOURCE CAL* softkey opens a submenu comprising of the calibration functions for the transmission and reflection measurement.

For information on the calibration of the reflection measurement (*CAL REFL SHORT* and *CAL REFL OPEN*) and its mechanisms, refer to section “Calibration of Reflection Measurement” on page 4.291.

To carry out a calibration for transmission measurements the whole test setup is through-connected (THRU).

CAL TRANS The *CAL TRANS* softkey triggers the calibration of the transmission measurement. It starts a sweep that records a reference trace. This trace is then used to calculate the difference for the normalized values.

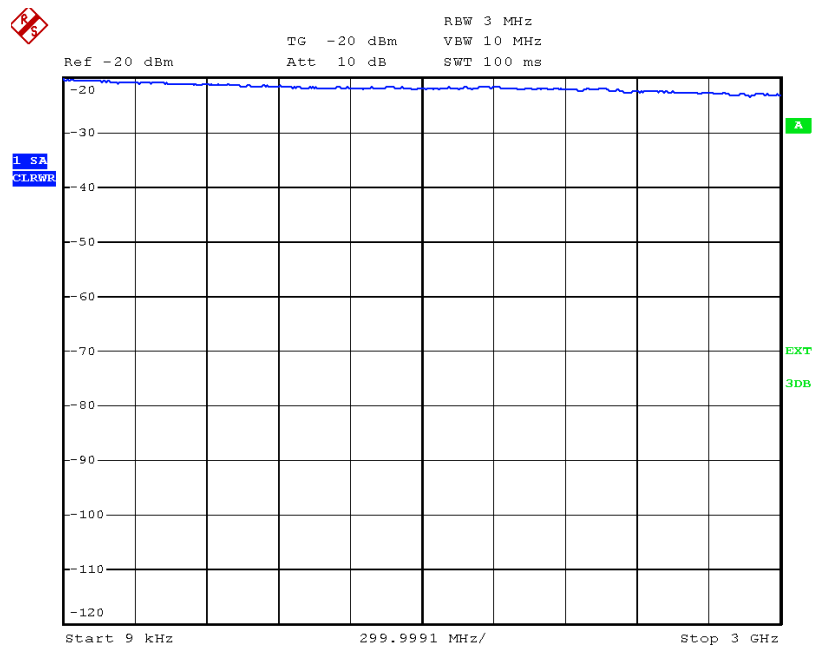

Fig. 4.21 Calibration curve for transmission measurement

During the calibration the following message is displayed:

```
REFERENCE MEASUREMENT
in progress
ABORT
```

After the calibration the following message is displayed:

```
NOTE
calibration complete
OK
```

This message will be cleared automatically after approx. 3 seconds.

Remote command: CORR:METH TRAN

4.9.2.2 Normalization

NORMALIZE The *NORMALIZE* softkey switches the normalization on or off. The softkey is only available if the memory contains a correction trace.

It is possible to shift the relative reference point within the grid using the *REF VALUE POSITION* softkey. Thus, the trace can be shifted from the upper border of the grid to the vertical center of the grid:

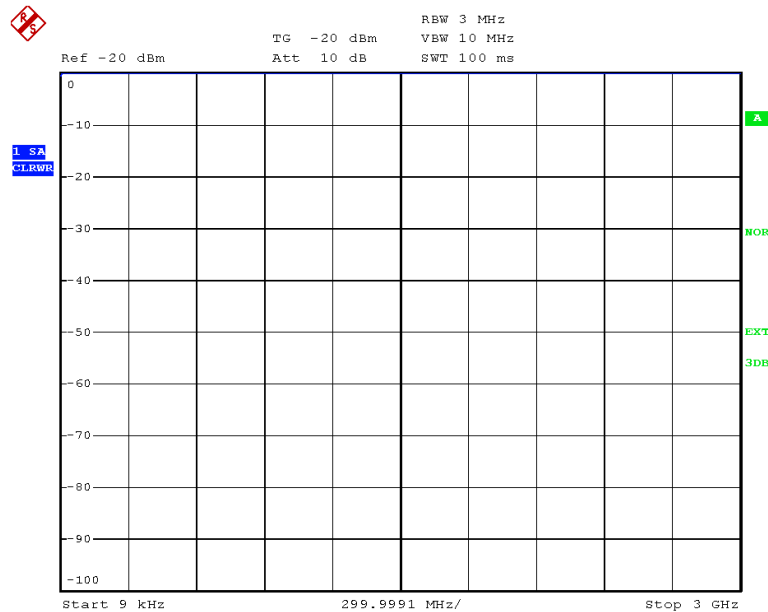

Fig. 4.22 Normalized display

In *SPLIT SCREEN* operation, the normalization is switched on in the currently active window. Different types of normalization can be active in the two windows.

Normalization is aborted when the *NETWORK* operating mode is quit.

Remote command: CORR ON

REF VALUE POSITION The *REF VALUE POSITION* softkey marks a reference position in the active window at which the normalization result (calculated difference with a reference trace) is displayed.

If no reference line is active, the softkey switches on a reference line and activates the input of its position. The line can be moved within the grid boundaries.

The reference line is switched off by pressing the softkey again.

The function of the reference line is explained in the section [“Calibration Mechanism”](#) on page 4.291.

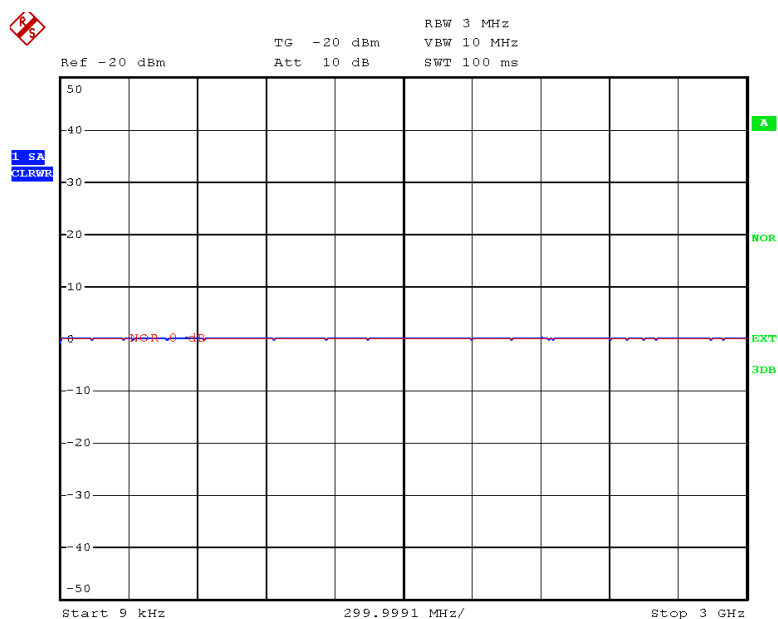

Fig. 4.23 Normalized measurement, shifted with REF VALUE POSITION 50%

Remote command: `DISP:WIND:TRAC:Y:RPOS 10PCT`

REF VALUE The *REF VALUE* softkey activates the input of a value which is assigned to the reference line.

With default settings the reference line corresponds to a difference of 0 dB between the currently measured trace and the reference trace. Setting the *REF VALUE* to a different value helps to compensate for changes to the level conditions in the signal path after the calibration data have been recorded. If e.g. after a source calibration a 10 dB attenuation is inserted into the signal path between DUT and R&S ESCI input, the measurement trace will be moved by 10 dB down. Entering a *REF VALUE* of – 10 dB will then result in the reference line for difference calculation being moved by 10 dB down as well. This means that the measured trace will be placed on it, as displayed in Fig. 4.24.

REF VALUE always refers to the active window.

Tracking Generator – Option R&S FSP-B9

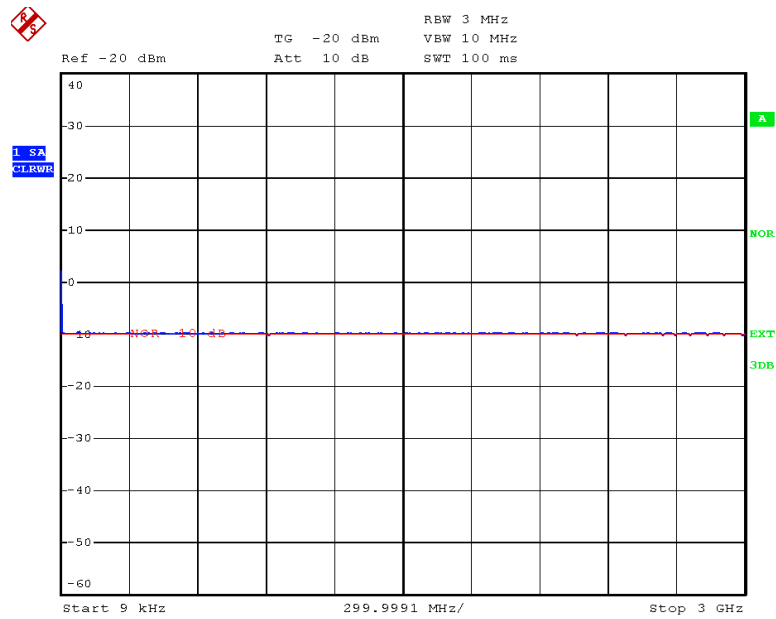

Fig. 4.24 Measurement with REF VALUE -10 dB and REF VALUE POSITION 50%

After the reference line has been moved by entering a *REF VALUE* of -10 dB the deviation from the nominal power level can be displayed with high resolution (e.g. 1 dB/div). The power is still displayed in absolute values, which means that in the above example 1 dB below the nominal power (reference line) = 11 dB attenuation.

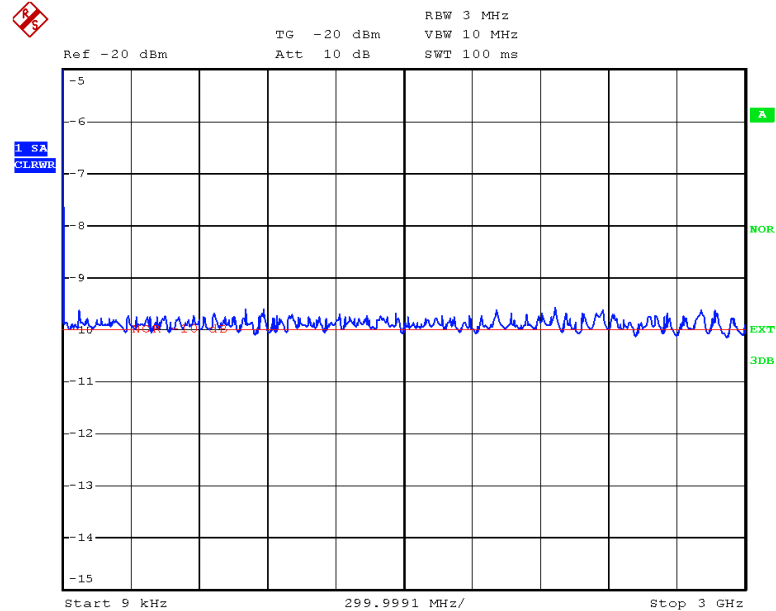

Fig. 4.25 Measurement of a 10dB attenuator pad with 1dB/DIV

Remote command: `DISP:WIND:TRAC:Y:RVAL -10dB`

RECALL The *RECALL* softkey restores the R&S ESCI settings that were used during source calibration.

This can be useful if device settings were changed after calibration (e.g. center frequency, frequency deviation, reference level, etc.).

The softkey is only available if:

- the NETWORK mode has been selected
- the memory contains a calibration data set.

Remote command: `CORR:REC`

SAVE AS TRD FACTOR *SAVE AS TRD FACTOR* uses the normalized measurement data to generate a transducer factor with up to 501 points. The trace data are converted to a transducer with unit dB after the transducer name has been entered. The number of points is defined by *SWEEP COUNT*. The frequency points are allocated in equidistant steps between start and stop frequency. The generated transducer factor can be further adapted in the *SETUP* menu – *TRANSDUCER*. The *SAVE AS TRD FACTOR* softkey is only available if normalization is switched on.

Remote command: `CORR:TRAN:GEN <name>'`

4.9.3 Reflection Measurement

Scalar reflection measurements can be carried out by means of a reflection-coefficient measurement bridge.

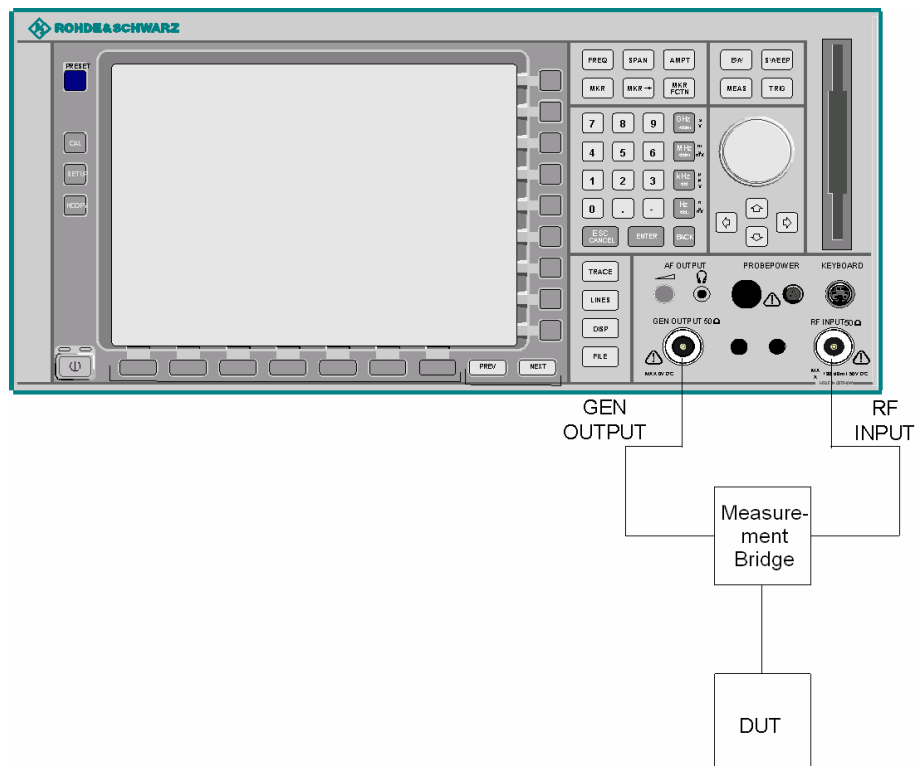

Fig. 4.26 Test Setup for Reflection Measurement

4.9.3.1 Calibration of Reflection Measurement

The calibration mechanism for reflection measurement is basically the same as the one used for transmission measurement.

CAL REFL
SHORT

The *CAL REFL SHORT* softkey starts the short-circuit calibration.

If both calibrations (open circuit, short circuit) are carried out, the calibration curve is calculated by averaging the two measurements and stored in the memory. The order of the two calibration measurements is free.

After the calibration the following message is displayed:

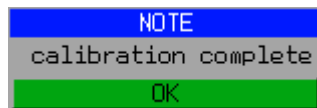

The message is cleared after approx. 3 seconds.

Remote command: CORR:METH REFL
 CORR:COLL THR

CAL REFL
OPEN

The *CAL REFL OPEN* softkey starts the open-circuit calibration. During calibration the following message is displayed:



Remote command: CORR:METH REFL
 CORR:COLL OPEN

4.9.4 Calibration Mechanism

Calibration means a calculation of the difference between the currently measured power and a reference curve, independent of the selected type of measurement (transmission/reflection). The hardware settings used for measuring the reference curve are included in the reference data set.

Even with normalization switched on, the device settings can be changed in a wide area without stopping the normalization. This reduces the necessity to carry out a new normalization to a minimum.

For this purpose the reference dataset (trace with 501 measured values) is stored internally as a table of 501 points (frequency/level).

Differences in level settings between the reference curve and the current device settings are taken into account automatically. If the span is reduced, a linear interpolation of the intermediate values is applied. If the span increases, the values at the left or right border of the reference data set are extrapolated to the current start or stop frequency, i.e. the reference data set is extended by constant values.

An enhancement label is used to mark the different levels of measurement accuracy. This enhancement label is displayed at the right diagram border when normalization is switched on and a deviation from the reference setting occurs. Three accuracy levels are defined:

Table 4-6 Measurement accuracy levels

Accuracy	Enhancement label	Reason/Limitation
High	NOR	No difference between reference setting and measurement
Medium	APX (approximation)	Change of the following settings: <ul style="list-style-type: none"> • coupling (RBW, VBW, SWT) • reference level, RF attenuation • start or stop frequency • output level of tracking generator • frequency offset of tracking generator • detector (max. peak, min. peak, sample, etc.) Change of frequency: <ul style="list-style-type: none"> • max. 501 points within the set sweep limits (corresponds to a doubling of the span)
-	Aborted normalization	<ul style="list-style-type: none"> • 501 and more extrapolated points within the current sweep limits (in case of span doubling)



At a reference level (*REF LEVEL*) of -10 dBm and at a tracking generator output level of the same value the R&S ESCI operates without overrange reserve, i.e. the R&S ESCI is in danger of being overloaded if a signal is applied whose amplitude is higher than the reference line. In this case, either the message *OVLD* for overload is displayed in the status line or the display range is exceeded (clipping of the trace at the upper diagram border = Overrange).

Overloading can be avoided as follows:

- Reducing the output level of the tracking generator (*SOURCE POWER*, *NETWORK* menu)
- Increasing the reference level (*REF LEVEL*, *AMPT* menu)

4.9.5 Frequency-Converting Measurements

For frequency-converting measurements (e.g. on converter units) the tracking generator is able to set a constant frequency offset between the output frequency of the tracking generator and the receive frequency of the R&S ESCI.

Up to an output frequency of 150 MHz the measurement can be carried out in both inverted and normal positions.

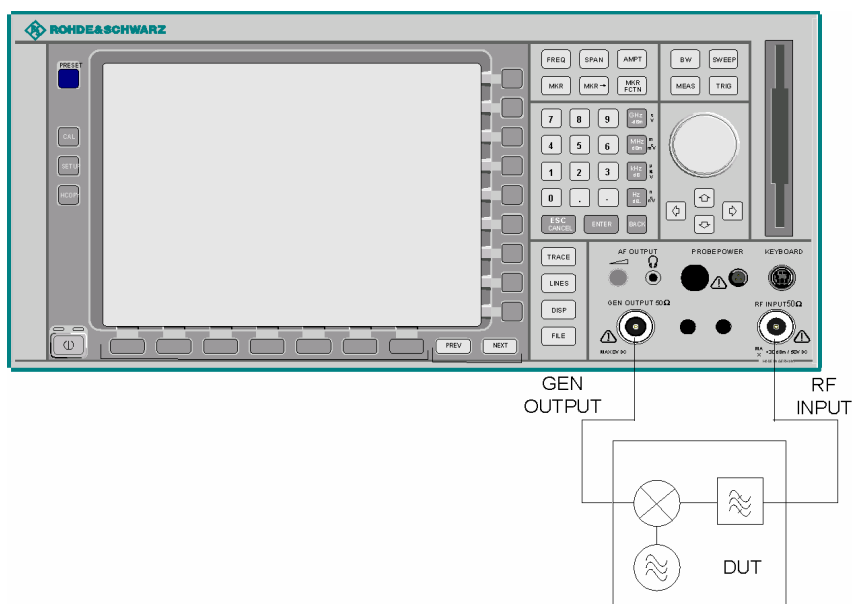

Fig. 4.27 Test setup for frequency converting measurements

FREQUENCY OFFSET

The *FREQUENCY OFFSET* softkey activates the input of the frequency offset between the output signal of the tracking generator and the input frequency of the R&S ESCI. Possible offsets are in a range of ± 150 MHz in 0.1 Hz steps.

The default setting is 0 Hz. Offsets $\neq 0$ Hz are marked with the enhancement label *FRQ*.

If a positive frequency offset is entered, the tracking generator generates an output signal above the receive frequency of the R&S ESCI. In case of a negative frequency offset it generates a signal below the receive frequency of the R&S ESCI. The output frequency of the tracking generator is calculated as follows:

$$\text{Tracking generator frequency} = \text{receive frequency} + \text{frequency offset.}$$

Remote command: `SOUR:FREQ:OFFS 50MHz`

4.9.6 External Modulation of the Tracking Generator

MODULATION

EXT AM
EXT FM
EXT I/Q
MODULATION OFF

The *MODULATION* softkey opens a submenu for selecting different modulation modes.

The time characteristics of the tracking generator output signal can be influenced by means of external signals (input voltage range -1 V to +1 V).

Two BNC connectors at the rear panel are available as signal inputs. Their function changes depending on the selected modulation:

- *TG IN I / AM* and
- *TG IN Q / FM*

The modulation modes can be combined with each other and with the frequency offset function up to a certain degree. The following table shows which modulation modes are possible at the same time and which ones can be combined with the frequency offset function.

Table 4-7 Simultaneous modes of modulation (tracking generator)

Modulation	Frequency offset	EXT AM	EXT FM	EXT I/Q
Frequency offset		●	●	●
EXT AM	●		●	
EXT FM	●	●		
EXT I/Q	●			

● = can be combined

EXT AM The *EXT AM* softkey activates an AM modulation of the tracking generator output signal.

The modulation signal is applied to the *TG IN I / AM* connector. An input voltage of 1 V corresponds to 100% amplitude modulation.

Switching on an external AM disables the active I/Q modulation.

Remote command: `SOUR:AM:STAT ON`

EXT FM The *EXT FM* softkey activates the FM modulation of the tracking generator output signal.

The modulation frequency range is 1 kHz to 100 kHz, the deviation can be set in 1-decade steps in the range of 100 Hz to 10 MHz at an input voltage of 1 V. The phase deviation h should not exceed the value 100.

Phase deviation $h = \text{deviation} / \text{modulation frequency}$

The modulation signal is applied to the TG IN Q / FM connector.

Switching on an external FM disables the active I/Q modulation.

Remote command: SOUR:FM:STAT ON
 SOUR:FM:DEV 10MHz

EXT I/Q The *EXT I/Q* softkey activates the external I/Q modulation of the tracking generator.

The signals for modulation are applied to the two input connectors *TG IN I* and *TG IN Q* at the rear panel of the unit. The input voltage range is ± 1 V into 50Ω .

Switching on an external I/Q modulation disables the following functions:

- active external AM
- active external FM

Functional description of the quadrature modulator:

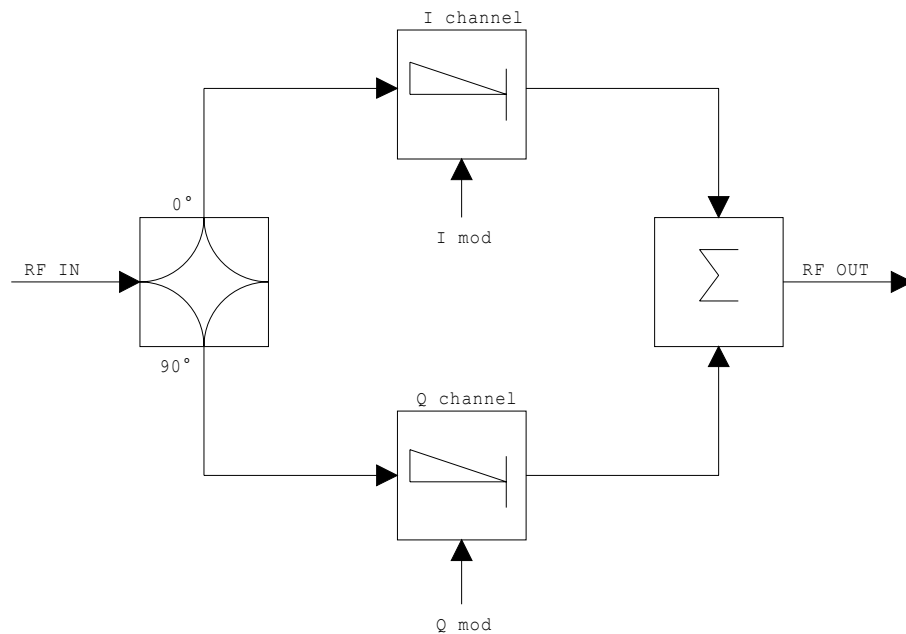

Fig. 4.28 I/Q modulation

I/Q modulation is performed by means of the built-in quadrature modulator. The RF signal is divided into two orthogonal I and Q components (in phase and quadrature phase). Amplitude and phase are controlled in each path by the I and Q modulation signal. By adding the two components an RF output signal is generated that can be controlled in amplitude and phase.

Remote command: SOUR:DM:STAT ON

MODULATION OFF The *MODULATION OFF* softkey switches off the modulation of the tracking generator.

Remote command: SOUR:AM:STAT OFF
 SOUR:FM:STAT OFF
 SOUR:DM:STAT OFF

4.9.7 Power Offset of the Tracking Generator

POWER SWEEP

POWER SWP ON/OFF
START POWER
STOP POWER

The *POWER SWEEP* softkey opens a submenu for activates or deactivates the power sweep.

POWER SWP ON/OFF

The *POWER SWP ON/OFF* softkey activates or deactivates the power sweep. If the power sweep is ON the enhancement label TGPWR is shown and the EMI Test Receiver is set in zero span mode (span = 0Hz). During the sweep time of the zero span the power at the internal tracking generator is changed linear from start power to stop power. The start and stop power values are shown on the right side below the diagram.

Remote command: : SOUR:POW:MODE SWE
 : SOUR:POW:MODE FIX

START POWER

The *START POWER* softkey defines the start power of the power sweep.
The start power can be set between -30 dBm and +0 dBm.

Remote command: : SOUR:POW:STAR -20dBm

STOP POWER

The *STOP POWER* softkey defines the stop power of the power sweep.
The start power can be set between -30 dBm and +0 dBm.
The stop value can be smaller than the start value.

Remote command: : SOUR:POW:STOP -10dBm

4.10 External Generator Control – Option R&S FSP-B10

The external generator control option permits to operate a number of commercially available generators as tracking generator on the R&S ESCI. Thus, scalar network analysis with the R&S ESCI is also possible outside the frequency range of the internal tracking generator when the appropriate generators are used.

The R&S ESCI also permits to set a frequency offset for frequency-converting measurements when external generators are used. For harmonics measurements or frequency-converting measurements, it is also possible to enter a factor, by which the generator frequency is increased or reduced compared with the receive frequency of the R&S ESCI. Only make sure that the resulting generator frequencies do not exceed the allowed setting range of the generator.

The level range to be set also depends on the generator used.

The generator is controlled via the – optional – second GPIB interface of the R&S ESCI (= IEC2, supplied with the option) and, with some Rohde & Schwarz generators, additionally via the TTL synchronization interface included in the AUX interface of the R&S ESCI.



The use of the TTL interface enables considerably higher measurement rates as pure GPIB control, because the frequency stepping of the R&S ESCI is directly coupled with the frequency stepping of the generator.

Therefore, the frequency sweep differs according to the capabilities of the generator used:

- In the case of generators without TTL interface, the generator frequency is first set for each frequency point via GPIB, then the setting procedure has to be completed before recording of measured values is possible.
- In the case of generators with TTL interface, a list of the frequencies to be set is entered into the generator before the beginning of the first sweep. Then the sweep is started and the next frequency point selected by means of the TTL handshake line TRIGGER. The recording of measured values is only enabled when the generator signals the end of the setting procedure via the BLANK signal. This method is considerably faster than pure GPIB control.

With the *SELECT GENERATOR* softkey, a list of the supported generators with the frequency and level range as well as the capabilities used is included.

The external generator can be used in all operating modes. Recording of test setup calibration values (*SOURCE CAL*) and normalization with the correction values (*NORMALIZE*) are only possible in the *NETWORK* mode.



In order to enhance measurement accuracy a common reference frequency should be used for both the R&S ESCI and the generator. If no independent 10 MHz reference frequency is available, it is recommended to connect the reference output of the generator with the reference input of the R&S ESCI and to enable usage of the external Reference on the R&S ESCI via *SETUP - REFERENCE EXT*.

Like the internal tracking generator, the external generator is activated by means of the hotkey bar: *MORE* hotkey - *NETWORK* hotkey (for details refer to section "[Mode Selection – Hotkey Bar](#)" on page 4.9).



The external generator control is only available in the spectrum analyzer mode and not in the receiver mode.

4.10.1 External Generator Settings

NETWORK

The *NETWORK* hotkey opens the menu for setting the functions of the external generator.

SOURCE POWER	
POWER OFFSET	
SOURCE CAL ↓	CAL TRANS
	CAL REFL SHORT
	CAL REFL OPEN
	NORMALIZE
	REF VALUE POSITION
	REF VALUE
	RECALL
	SAVE AS TRD FACTOR
FREQUENCY OFFSET	
EXT SOURCE ↓	EXT SRC ON / OFF
	SELECT GENERATOR
	FREQUENCY SWEEP
	GEN REF INT / EXT



Other softkeys are available in the displayed menus for controlling the internal tracking generator when option Tracking Generator R&S FSP-B9 is fitted. For detailed information see section “Tracking Generator – Option R&S FSP-B9” on page 4.283.

SOURCE POWER

The *SOURCE POWER* softkey activates the entry of the generator output level. The value range depends on the selected generator. For detailed information see “List of Generator Types Supported by the R&S ESCI” on page 4.311.

If both option External Generator Control B10 and option Tracking Generator B9 are installed, the softkey will modify the output power of the generator currently in use.

The default output power is -20 dBm.

Remote command: `SOUR:EXT:POW -20dBm`

POWER OFFSET

The *POWER OFFSET* softkey activates the entry of a constant level offset of the generator. With this offset, attenuator pads or amplifiers connected to the output connector of the generator can be handled during the input and output of output levels.

The permissible setting range is -200 dB to +200 dB in steps of 0.1 dB. Positive offsets handle a subsequent amplifier and negative offsets an attenuator pad.

The default setting is 0 dB; offsets $\neq 0$ are marked by the activated enhancement label *LVL*.

Remote command: `SOUR:POW:OFFS -10dB`

4.10.2 Transmission Measurement

The transmission characteristic of a two-port network is measured. The external generator serves as a signal source. It is connected to the input connector of the DUT. The input of the R&S ESCI is fed from the output of the DUT.

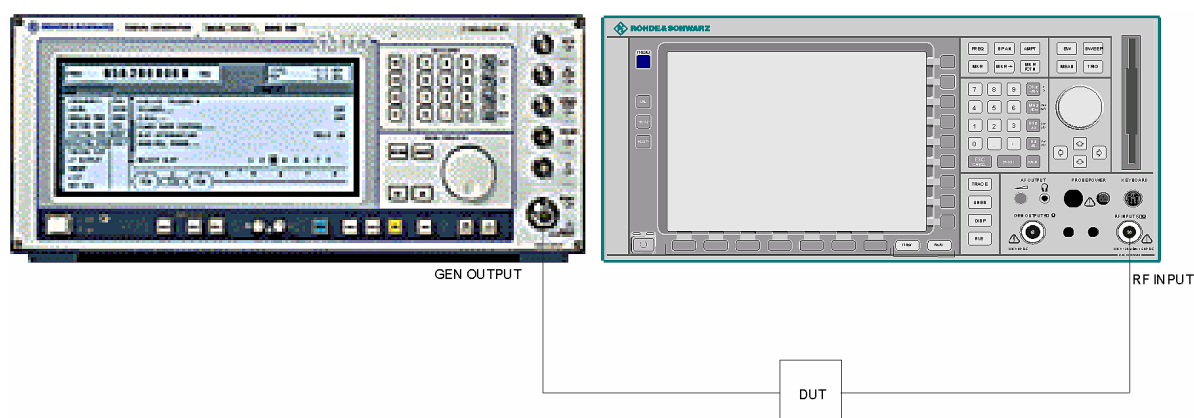

Fig. 4.29 Test setup for transmission measurement

A calibration can be carried out to compensate for the effects of the test setup (e.g. frequency response of connecting cables).

4.10.2.1 Calibration of Transmission Measurement

SOURCE CAL

CAL TRANS
CAL REFL SHORT
CAL REFL OPEN
NORMALIZE
REF VALUE POSITION
REF VALUE
RECALL
SAVE AS TRD FACTOR

The *SOURCE CAL* softkey opens a submenu comprising the calibration functions for the transmission and reflection measurement.

For information on the calibration of the reflection measurement (*CAL REFL SHORT* and *CAL REFL OPEN*) and its mechanisms, refer to section [“Calibration of Reflection Measurement”](#) on page 4.305.

To carry out a calibration for transmission measurements the whole test setup is through-connected (THRU).

CAL TRANS The *CAL TRANS* softkey triggers the calibration of the transmission measurement. It starts a sweep that records a reference trace. This trace is then used to obtain the differences to the normalized values.

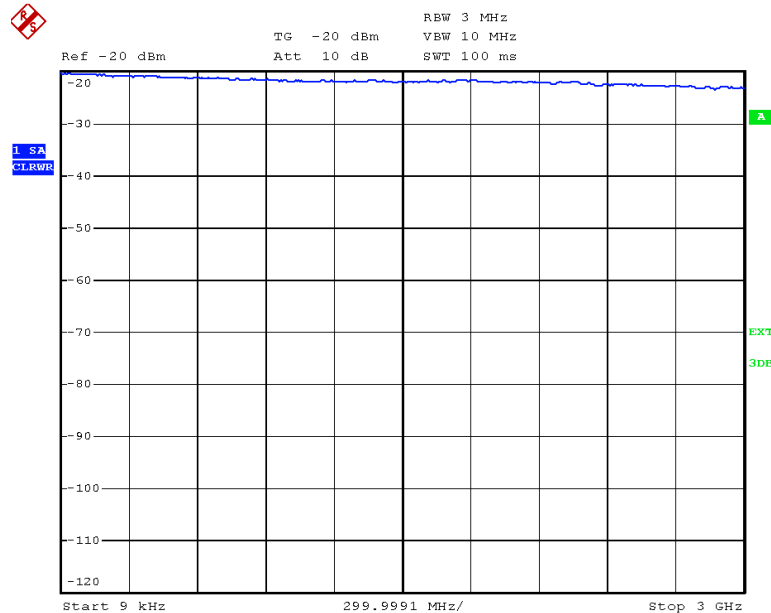

Fig. 4.30 Calibration curve for transmission measurement

During the calibration the following message is displayed:

```
REFERENCE MEASUREMENT
in progress
ABORT
```

After the calibration sweep the following message is displayed:

```
NOTE
calibration complete
OK
```

This message is cleared after approx. 3 seconds.

Remote command: CORR:METH TRAN

4.10.2.2 Normalization

NORMALIZE The *NORMALIZE* softkey switches normalization on or off. The softkey is only available if the memory contains a correction trace.

It is possible to shift the relative reference point within the grid using the *REF VALUE POSITION* softkey. Thus, the trace can be shifted from the top grid margin to the middle of the grid:

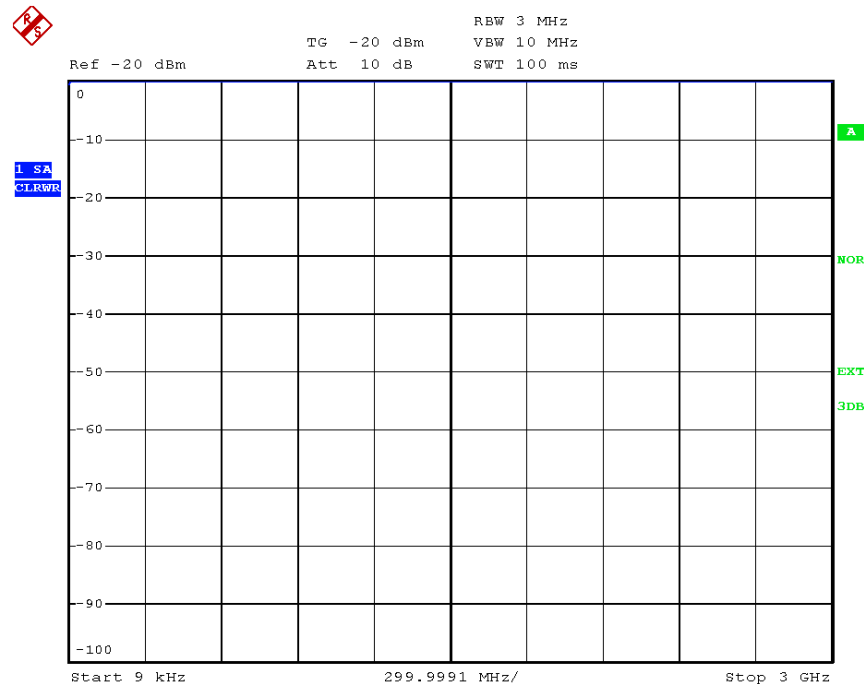

Fig. 4.31 Normalized display

In the *SPLIT SCREEN* setting, the normalization is switched on in the current window. Different normalizations can be active in the two windows.

Normalization is aborted when the *NETWORK* mode is quit.

Remote command: CORR ON

REF VALUE POSITION The *REF VALUE POSITION* softkey (reference position) marks a reference position in the active window on which the normalization (difference formation with a reference curve) is performed.

When pressed for the first time, the softkey switches on the reference line and activates the input of its position. The line can be shifted within the grid limits.

The reference line is switched off by pressing the softkey again.

The function of the reference line is explained in the section [“Calibration Mechanism”](#) on page 4.305.

External Generator Control – Option R&S FSP-B10

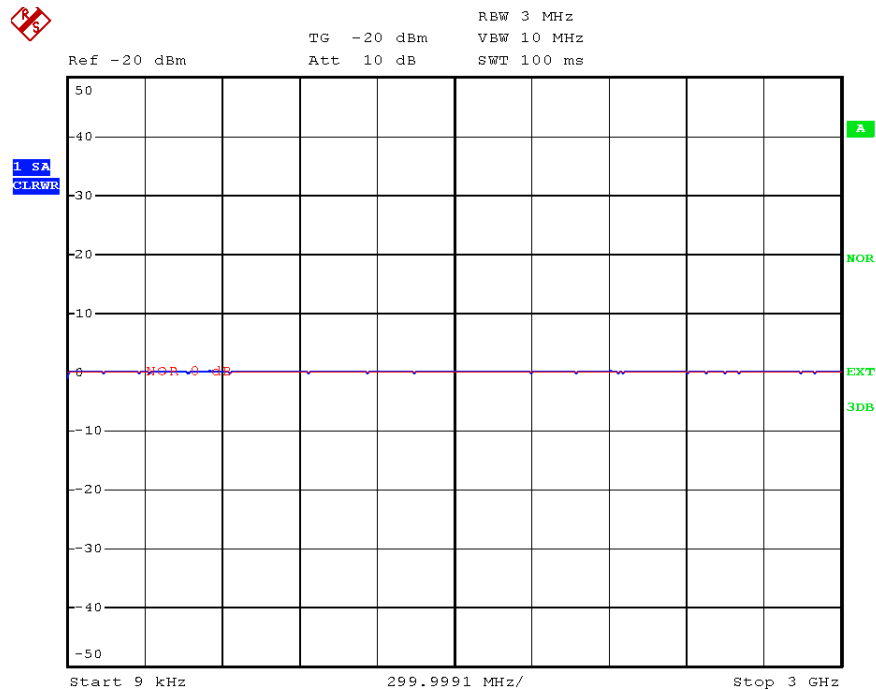

Fig. 4.32 Normalized measurement, shifted with REF VALUE POSITION 50%

Remote command: `DISP:WIND:TRAC:Y:RPOS 10PCT`

REF VALUE The *REF VALUE* softkey activates the input of a level difference which is assigned to the reference line.

In the default setting, the reference line corresponds to a level difference of 0 dB. If e.g. a 10-dB attenuator pad is inserted between DUT and R&S ESCI input between recording of the calibration data and normalization, the trace will be shifted down by 10 dB. By entering a *REF VALUE* of -10 dB the reference line for difference formation can also be shifted down by 10 dB so that it will again coincide with the trace (see Fig. 4.33).

External Generator Control – Option R&S FSP-B10

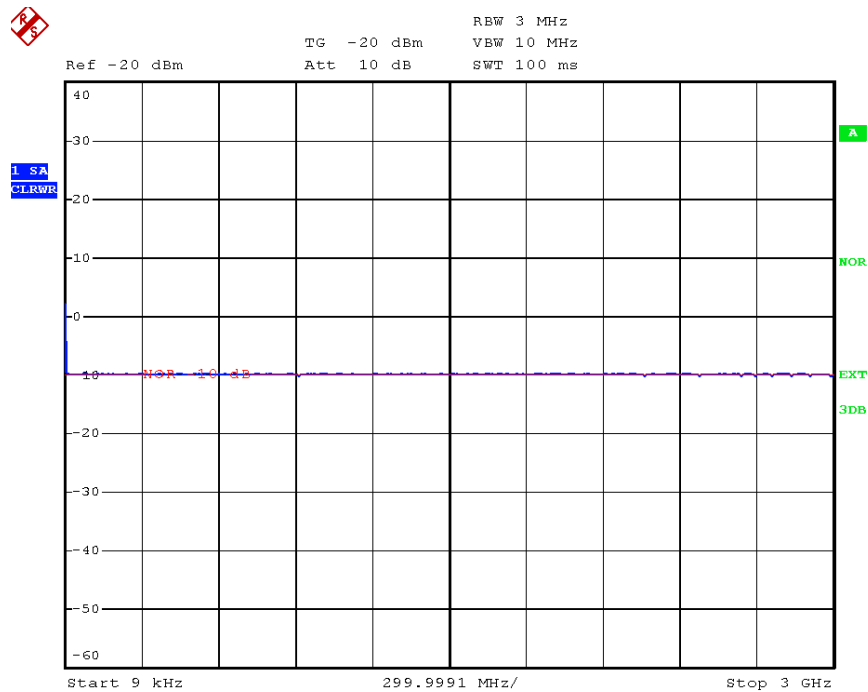

Fig. 4.33 Measurement with REF VALUE -10dB and REF VALUE POSITION 50%

After the reference line has been shifted by entering *REF VALUE* -10 dB, departures from the nominal value can be displayed with high resolution (e.g. 1 dB / Div.). The absolute measured values are still displayed, in the above example, 1 dB below nominal value (reference line) = 11 dB attenuation.

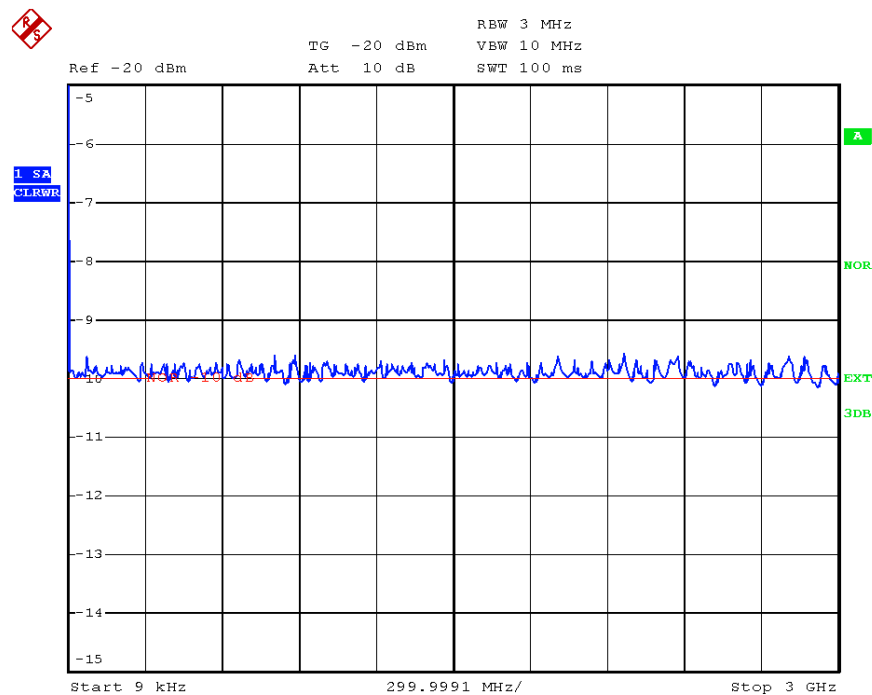

Fig. 4.34 Measurement of a 10-dB attenuator pad with 1dB/DIV

Remote command: `DISP:WIND:TRAC:Y:RVAL -10dB`

RECALL The *RECALL* softkey restores the instrument setting with which the calibration was carried out.

This can be useful if the device setting was changed after calibration (e.g. center frequency setting, frequency deviation, reference level, etc.).

The softkey is only available if:

- the *NETWORK* mode has been selected
- the memory contains a calibration data set.

Remote command: `CORR:REC`

SAVE AS TRD FACTOR *SAVE AS TRD FACTOR* uses the normalized measurement data to generate a transducer factor with up to 501 points. The trace data are converted to a transducer with unit dB after the transducer name has been entered. The number of points is defined by *SWEEP COUNT*. The frequency points are allocated in equidistant steps between start and stop frequency. The generated transducer factor can be further adapted in the menu *SETUP – TRANSDUCER*. *SAVE AS TRD FACTOR* is only available if normalization is switched on.

Remote command: `CORR:TRAN:GEN <name>'`

4.10.3 Reflection Measurement

Scalar reflection measurements can be carried out by means of a reflection-coefficient bridge.

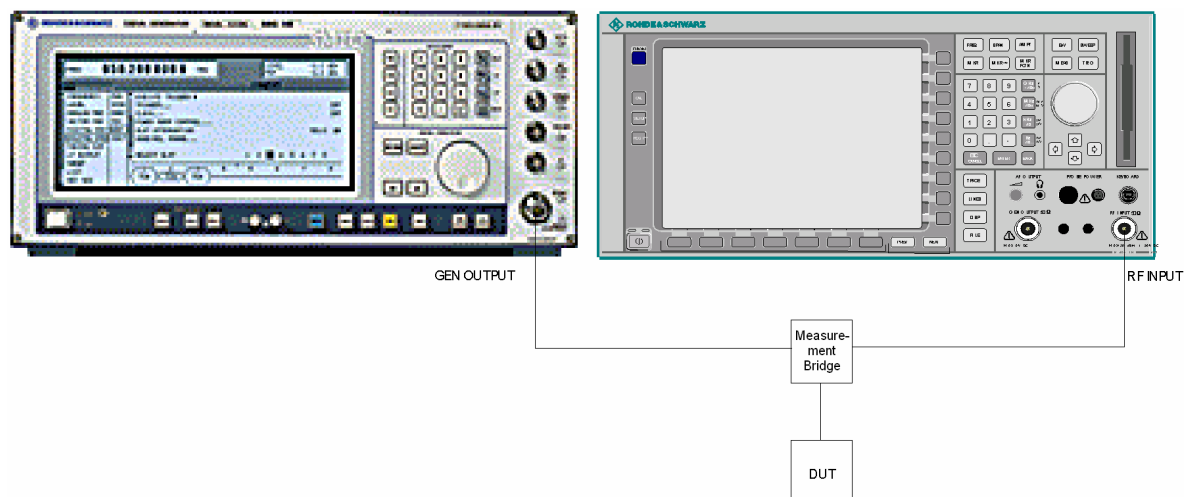

Fig. 4.35 Test setup for reflection measurement

4.10.3.1 Calibration of Reflection Measurement

The calibration mechanism essentially corresponds to that of the transmission measurement.

CAL REFL
SHORT The *CAL REFL SHORT* softkey starts the short-circuit calibration.

If both calibrations (open circuit, short circuit) are carried out, the calibration curve is formed by averaging the two measurements and stored in the memory. The order of measurements is optional.

After the calibration the following message is displayed:

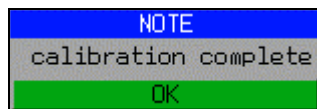

The display is cleared after approx. 3 seconds.

Remote command: CORR:METH REFL
 CORR:COLL THR

CAL REFL
OPEN The *CAL REFL OPEN* softkey starts the open-circuit calibration. During calibration the following message is displayed:



Remote command: CORR:METH REFL
 CORR:COLL OPEN

4.10.4 Calibration Mechanism

Calibration means a calculation of the difference between the currently measured power and a reference curve, independent of the selected type of measurement (transmission/reflection). The hardware settings used for measuring the reference curve are included in the reference data set.

Even with normalization switched on, the device settings can be changed in a wide area without stopping the normalization. This reduces the necessity to carry out a new normalization to a minimum.

For this purpose, the reference dataset (trace with 501 measured values) is stored as a table with 501 points (frequency/level).

Differences in level settings between the reference curve and the current device settings are taken into account automatically. If the span is reduced, a linear interpolation of the intermediate values is applied. If the span increases, the values at the left or right border of the reference data set are extrapolated to the current start or stop frequency, i.e. the reference data set is extended by constant values.

An enhancement label is used to mark the different levels of measurement accuracy. This enhancement label is displayed at the right diagram border when normalization is switched on and a deviation from the reference setting occurs. Three accuracy levels are defined:

Table 4-8 Measurement accuracy levels

Accuracy	Enhancement label	Reason/Limitation
High	NOR	No difference between reference setting and measurement
Medium	APX (approximation)	Change of the following settings: <ul style="list-style-type: none"> • coupling (RBW, VBW, SWT) • reference level, RF attenuation • start or stop frequency • output level of tracking generator • frequency offset of tracking generator • detector (max. peak, min. peak, sample, etc.) Change of frequency: <ul style="list-style-type: none"> • max. 501 points within the set sweep limits (corresponds to a doubling of the span)
-	Aborted normalization	<ul style="list-style-type: none"> • more than 500 extrapolated points within the current sweep limits (in case of span doubling)



At a reference level (*REF LEVEL*) of -10 dBm and at a tracking generator output level of the same value the analyzer operates without overrange reserve, i.e. the analyzer is in danger of being overloaded if a signal is applied whose amplitude is higher than the reference line. In this case, either the message *OVL* for overload is displayed in the status line or the display range is exceeded (clipping of the trace at the upper diagram border = Overrange).

Overloading can be avoided as follows:

- Reducing the output level of the tracking generator (*SOURCE POWER*, *NETWORK* menu)
- Increasing the reference level (*REF LEVEL*, *AMPT* menu)

4.10.5 Frequency-Converting Measurements

For frequency-converting measurements (e.g. on converters) the external generator is able to set a constant frequency offset between the output frequency of the generator and the receive frequency of the R&S ESCI and, in addition, the generator frequency as a multiple of the R&S ESCI.

Fig. 4.36 Test setup for frequency-converting measurements

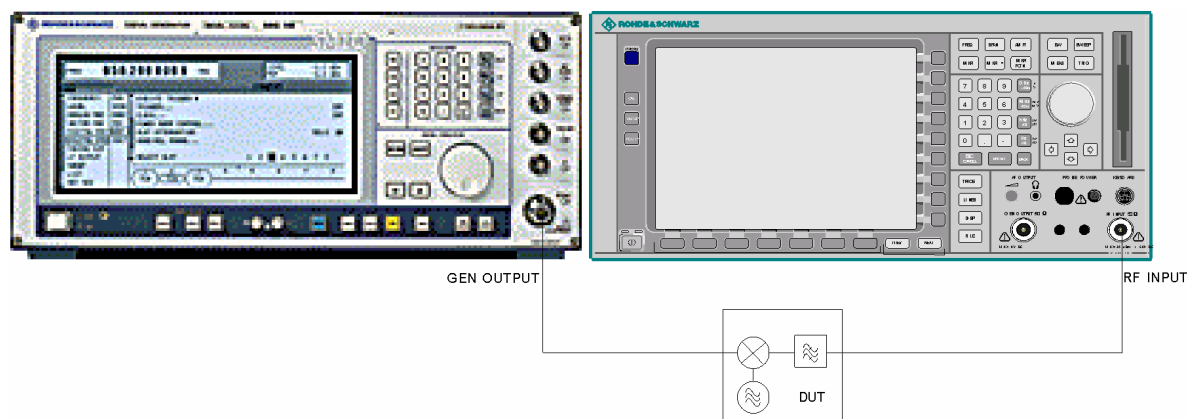

FREQUENCY OFFSET

The *FREQUENCY OFFSET* softkey activates the input of the frequency offset between the output signal of the generator and the input frequency of the R&S ESCI. The value range depends on the selected generator.

The default setting is 0 Hz. Offsets $\neq 0$ Hz are marked with the enhancement label *FRQ*.

If a positive frequency offset is entered, the tracking generator generates an output signal above the receive frequency of the analyzer. In case of a negative frequency offset it generates a signal below the receive frequency of the analyzer. The output frequency of the generator is calculated as follows:

$$\text{Generator frequency} = \text{receive frequency} + \text{frequency offset}$$

Remote command: `SOUR:EXT:FREQ:OFFS 1GHZ`

4.10.6 Configuration of an External Generator

EXT SOURCE

EXT SRC ON / OFF
SELECT GENERATOR
FREQUENCY SWEEP
GEN REF INT / EXT

RBW 3 MHz
UBW 10 MHz

Ref -20 dBm Att 10 dB

SELECT GENERATOR								
SRC	TYPE	IFC	GPIB ADDR	MODE	F MIN	F MAX	P MIN	P MAX
1	SME03	TTL	28	REMOTE	5kHz	3GHz	-144dBm	16dBm
2	SNIQ03	GPIB	28	LOCAL	300kHz	3.3GHz	-140dBm	13dBm

FREQUENCY SWEEP						
SOURCE FREQ = REC FREQ * NUM/DEN + OFFSET						
SRC	STATE	POWER[dBm]	NUM	DEN	OFFSET	RESULT
1	<input checked="" type="checkbox"/>	-30dBm	1	1	0Hz	0Hz..3GHz *
2	<input type="checkbox"/>	-30dBm	1	1	0Hz	0Hz..3.2GHz

Start 0 Hz 320 MHz/ Stop 3.2 GHz

Buttons: EXT SRC ON OFF, SELECT GENERATOR, FREQUENCY SWEEP, GEN REF INT EXT, SPECTRUM NETWORK, SCREEN B

The *EXT SOURCE* softkey opens a submenu for configuration of the external generator.

The R&S ESCI is able to manage two generators, one of which can be active at the time.

EXT SRC ON /
OFF

The *EXT SRC ON / OFF* softkey switches the external generator on or off.

It can only be switched on successfully if the generator has been selected by means of *SELECT GENERATOR* and configured correctly by means of *FREQUENCY SWEEP*. If one of these conditions is not fulfilled, an error message will be output.



When switching on the external generator by means of *EXT SRC ON*, the R&S ESCI switches off the internal tracking generator and starts programming the generator settings via the GPIB interface IEC2.

Programming requires takeover of the remote control at this interface by the R&S ESCI. To avoid any access conflicts, ensure that no other controller is connected to the IEC2 interface or the external generator when selecting *EXT SRC ON*.

The maximum stop frequency is limited to the maximum generator frequency. This upper limit is automatically reduced by the set frequency offset of the generator and a set multiplication factor.

With the external generator switched on, the FFT filters (*FILTER TYPE FFT* in the menu *BW*) are not available.

If an error occurs on the GPIB when programming the external generator, the generator will automatically be switched off and the following error message will be output:



When the external generator is switched off using *EXT SRC OFF*, the GPIB control is handed over again at the IEC2 interface, i.e. a different controller will then take over the control of the signal generator.

Remote command: SOUR:EXT ON

SELECT
GENERATOR

The *SELECT GENERATOR* softkey opens a table for selection of the generator and definition of GPIB address and control interface.

The table permits configuration of two generators so that switching between two different configurations is easily possible.

SELECT GENERATOR								
SRC	TYPE	IFC	GPIB ADDR	MODE	F MIN	F MAX	P MIN	P MAX
1	SME03	TTL	28	REMOTE	5kHz	3GHz	-144dBm	16dBm
2	SMIQ03	GPIB	28	LOCAL	300kHz	3.3GHz	-140dBm	13dBm

The individual fields contain the following settings:

- *SRC*
Index of generator selected
- *TYPE*

The field opens the list with the available generators:

After completion of the selection, the remaining fields of the table are filled with the generator characteristics.

A list of generator types supported by the R&S ESCI is to be found in section “[List of Generator Types Supported by the R&S ESCI](#)” on page 4.311.

- *IFC*

This field selects the interface type of external generator 1 or 2. The following types are available:

- *GPIB*: GPIB only, suitable for all generators of other manufacturers and some Rohde & Schwarz instruments
- *TTL*: GPIB and TTL interface for synchronization, for most of the Rohde & Schwarz generators, see table above.

The two operating modes differ in the speed of the control: Whereas, with pure GPIB operation, each frequency to be set must be individually transferred to the generator, additional use of the TTL interface permits to program a total frequency list at once and subsequently perform the frequency stepping via TTL handshake, which is a big advantage in terms of speed.



Generators equipped with the TTL interface can also be operated with GPIB only.

Only one of the two generators can be operated with TTL interface at a time. The other generator must be configured for GPIB.

- *GPIB ADDR*

GPIB address of the respective generator. Addresses from 0 to 30 are possible.

- *MODE*

Operating mode of generator. The generator activated using the *FREQUENCY SWEEP* softkey is automatically set to remote mode (REMOTE), the other to manual operation (LOCAL).

- *F MIN F MAX*

Frequency range of generator. Select the start and stop frequency of the R&S ESCI in a way that the specified range is not exceeded. If the start frequency lies below *F MIN*, the generator is only switched on when *F MIN* is reached. If the stop frequency lies above *F MAX*, it is limited to *F MAX* when the generator is switched on using the *EXT SRC ON/OFF* softkey.

- *P MIN P MAX*

Level range of generator. This field defines the allowed input range for the *POWER* column in the *FREQUENCY SWEEP* table.

Remote command: `SYST:COMM:RDEV:GEN2:TYPE 'SMA01A'`
 `SYST:COMM:RDEV:GEN:LINK TTL`
 `SYST:COMM:GPIB:RDEV:GEN1:ADDR 28`

4.10.7 List of Generator Types Supported by the R&S ESCI



The R&S SMA and R&S SMU require the following firmware versions:

- R&S SMA: V2.10.x or higher
- R&S SMU: V1.10 or higher

Generator	Interface Type	Generator Min Freq	Generator Max Freq	Generator Min Power dBm	Generator Max Power dBm
SMA01A	TTL	9 kHz	3.0 GHz	-145	+30
SME02	TTL	5 kHz	1.5 GHz	-144	+16
SME03	TTL	5 kHz	3.0 GHz	-144	+16
SME06	TTL	5 kHz	6.0 GHz	-144	+16
SMG	GPIB	100 kHz	1.0 GHz	-137	+13
SMGL	GPIB	9 kHz	1.0 GHz	-118	+30
SMGU	GPIB	100 kHz	2.16 GHz	-140	+13
SMH	GPIB	100 kHz	2.0 GHz	-140	+13
SMHU	GPIB	100 kHz	4.32 GHz	-140	+13
SMIQ02B	TTL	300 kHz	2.2 GHz	-144	+13
SMIQ02E	GPIB	300 kHz	2.2 GHz	-144	+13
SMIQ03B	TTL	300 kHz	3.3 GHz	-144	+13
SMIQ03E	GPIB	300 kHz	3.3 GHz	-144	+13
SMIQ04B	TTL	300 kHz	4.4 GHz	-144	+10
SMIQ06B	TTL	300 kHz	6.4 GHz	-144	+10
SML01	GPIB	9 kHz	1.1 GHz	-140	+13
SML02	GPIB	9 kHz	2.2 GHz	-140	+13
SML03	GPIB	9 kHz	3.3 GHz	-140	+13
SMR20	TTL	1 GHz	20 GHz	-130 ²⁾	+11 ²⁾
SMR20B11 ¹⁾	TTL	10 MHz	20 GHz	-130 ²⁾	+13 ²⁾
SMR27	TTL	1 GHz	27 GHz	-130 ²⁾	+11 ²⁾
SMR27B11 ¹⁾	TTL	10 MHz	27 GHz	-130 ²⁾	+12 ²⁾
SMR30	TTL	1 GHz	30 GHz	-130 ²⁾	+11 ²⁾
SMR30B11 ¹⁾	TTL	10 MHz	30 GHz	-130 ²⁾	+12 ²⁾
SMR40	TTL	1 GHz	40 GHz	-130 ²⁾	+9 ²⁾
SMR40B11 ¹⁾	TTL	10 MHz	40 GHz	-130 ²⁾	+12 ²⁾
SMR50	TTL	1 GHz	50 GHz	-130 ²⁾	+9 ²⁾
SMR50B11 ¹⁾	TTL	10 MHz	50 GHz	-130 ²⁾	+12 ²⁾

External Generator Control – Option R&S FSP-B10

Generator	Interface Type	Generator Min Freq	Generator Max Freq	Generator Min Power dBm	Generator Max Power dBm
SMR60	TTL	1 GHz	60 GHz	-130 ²⁾	+9 ²⁾
SMR60B11 ¹⁾	TTL	10 MHz	60 GHz	-130 ²⁾	+12 ²⁾
SMP02	TTL	10 MHz	20 GHz	-130 ³⁾	+17 ³⁾
SMP03	TTL	10 MHz	27 GHz	-130 ³⁾	+13 ³⁾
SMP04	TTL	10 MHz	40 GHz	-130 ³⁾	+12 ³⁾
SMP22	TTL	10 MHz	20 GHz	-130 ³⁾	+20 ³⁾
SMT02	GPIB	5.0 kHz	1.5 GHz	-144	+13
SMT03	GPIB	5.0 kHz	3.0 GHz	-144	+13
SMT06	GPIB	5.0 kHz	6.0 GHz	-144	+13
SMV03	GPIB	9 kHz	3.3 GHz	-140	+13
SMU200A	TTL	100 kHz	2.2 GHz	-145	+13
SMU02B31	TTL	100 kHz	2.2 GHz	-145	+19
SMU03 ⁴⁾	TTL	100 kHz	3 GHz	-145	+13
SMU03B31	TTL	100 kHz	3 GHz	-145	+19
SMU04	TTL	100 kHz	4 GHz	-145	+13
SMU04B31	TTL	100 kHz	4 GHz	-145	+19
SMU06	TTL	100 kHz	6 GHz	-145	+13
SMU06B31	TTL	100 kHz	6 GHz	-145	+13
SMX	GPIB	100 kHz	1.0 GHz	-137	+13
SMY01	GPIB	9 kHz	1.04 GHz	-140	+13
SMY02	GPIB	9 kHz	2.08 GHz	-140	+13
HP8340A	GPIB	10 MHz	26.5 GHz	-110	10
HP8648	GPIB	9 kHz	4 GHz	-136	10
HP ESG-A Series 1000A, 2000A, 3000A, 4000A	GPIB	250 kHz	4 GHz	-136	20
HP ESG-D SERIES E4432B	GPIB	250 kHz	3 GHz	-136	+10

¹⁾ Requires the option SMR-B11 to be fitted.

²⁾ Maximum/minimum power depends on presence of Option SMR-B15/-B17 and set frequency range. For more details see SMR data sheet.

³⁾ Maximum/minimum power depends on presence of Option SMP-B15/-B17 and set frequency range. For more details see SMP data sheet.

External Generator Control – Option R&S FSP-B10

FREQUENCY SWEEP The *FREQUENCY SWEEP* softkey opens a table for setting the generator level as well as the multiplier and the offset used to derive the generator frequency from the analyzer frequency.

This table also permits configuration of two generators so that switching between two different configurations is easily possible.

FREQUENCY SWEEP						
SOURCE FREQ = REC FREQ * NUM/DEN + OFFSET						
SRC	STATE	POWER[dBm]	NUM	DEN	OFFSET	RESULT
1	✓	-30dBm	1	1	0Hz	0Hz..3GHz *
2		-30dBm	1	1	0Hz	0Hz..3.2GHz

The individual fields contain the following settings:

- *SRC*
Index of selected generator
- *STATE*
Selects the active generator. Only one generator can be active at a time. The operating mode of the active generator is set to remote control in the *SELECT GENERATOR* table.
- *POWER*
Permits to enter the generator level within the limits P MIN to P MAX of the *SELECT GENERATOR* table.
- *NUM*
Numerator,
- *DEN*
Denominator,
- *OFFSET*
Offset, used to derive the generator frequency from the current frequency of the R&S ESCI according to the following formula:

$$F_{\text{Generator}} = \left| F_{\text{Analyzer}} \cdot \frac{\text{Numerator}}{\text{Denominator}} + F_{\text{Offset}} \right|$$

Note that the frequencies resulting from start and stop frequency of the R&S ESCI do not exceed the allowed generator range:

- If the start frequency lies below F MIN, the generator is only switched on when F MIN is reached.
- If the stop frequency lies above F MAX, the generator is switched off. When the generator is subsequently switched on using the *EXT SRC ON/OFF* softkey, the stop frequency is limited to F MAX.
- If the stop frequency lies below F MIN, the generator is switched off and the following error message output:

```

ERROR
GENERATOR RANGES EXCEEDED; EXT GEN
SWITCHED OFF.

```

External Generator Control – Option R&S FSP-B10

- In the time domain (Span = 0 Hz) the generator frequency is derived from the set receive frequency of the R&S ESCI using the calculation formula.

For the sake of clarity, the formula is also displayed in the table.

The offset setting can be used to sweep in the reverse direction. This can be achieved by setting a **negative** offset in the formula above:

Example for reverse sweep:

$$F_{\text{AnalyzerStart}} = 100 \text{ MHz}$$

$$F_{\text{AnalyzerStop}} = 200 \text{ MHz}$$

$$F_{\text{Offset}} = -300 \text{ MHz}$$

$$\text{Numerator} = \text{Denominator} = 1$$

$$\rightarrow F_{\text{GeneratorStart}} = 200 \text{ MHz}$$

$$\rightarrow F_{\text{GeneratorStop}} = 100 \text{ MHz}$$

If the offset is adjusted in a way that the sweep of the generator crosses the 0 Hz Frequency, it is indicated by the additional statement “via 0 Hz”.

Example for reverse sweep via 0 Hz

$$F_{\text{AnalyzerStart}} = 100 \text{ MHz}$$

$$F_{\text{AnalyzerStop}} = 200 \text{ MHz}$$

$$F_{\text{Offset}} = -150 \text{ MHz}$$

$$\text{Numerator} = \text{Denominator} = 1$$

$$\rightarrow F_{\text{GeneratorStart}} = 50 \text{ MHz}$$

$$\rightarrow F_{\text{GeneratorStop}} = 50 \text{ MHz via 0 Hz}$$

Remote command: : SOUR:EXT:FREQ:NUM 1
 : SOUR:EXT:FREQ:DEN 1
 : SOUR:EXT:FREQ:OFFS -300MHZ

- **RESULT**

The frequency range of the generator resulting from the calculation formula. An asterisk (*) after the upper limit indicates that the stop frequency of the R&S ESCI must be adapted when the generator is switched on in order not to exceed its maximum frequency. In the following illustration, this is true for the upper generator at a stop frequency of 3.2 GHz of the R&S ESCI, whereas the lower generator does not yet require an adaptation:

SOURCE FREQ = REC FREQ * NUM/DEN + OFFSET				
	NUM	DEN	OFFSET	RESULT
	1	1	0Hz	0Hz..3GHz *
	1	1	0Hz	0Hz..3.2GHz

Remote command: SOUR:EXT:POW -30dBm
 SOUR:EXT:FREQ:NUM 4
 SOUR:EXT:FREQ:DEN 3
 SOUR:EXT:FREQ:OFFS 100MHZ

External Generator Control – Option R&S FSP-B10

GEN REF INT / EXT The *GEN REF INT / EXT* softkey switches over the reference oscillator of the generator (switch over between internal and external reference source). Selection *EXT* allows connecting the external generator to an external reference frequency source. The internal reference source is selected as the default setting.

Remote command: SOUR:EXT1:ROSC INT

4.11 LAN Interface - Option R&S FSP-B16

The instrument can be connected to an Ethernet LAN (local area network) using the LAN interface connector on the rear panel. This makes it possible to transfer data over the network and to use network printers. In addition, the instrument can be remote-controlled via the network.

For details, refer to the Quick Start Guide chapters 2, "Preparing for Use", 6, "LAN Interface".

4.11.1 NOVELL Networks

The operating system NETWARE from NOVELL is a server-based system. Data cannot be exchanged between individual workstations; data transfer takes place between the PC and a server. This server provides memory space and the connection to network printers. On a server, data is organized in directories as under DOS and mapped to the workstation as virtual drives. A virtual drive behaves like an additional hard disk on the workstation, and the data can be edited accordingly. Network printers can also be addressed like normal printers.

There are two versions of the NOVELL network operating system: bindery-based (NETWARE 3) and NDS-based (more recent versions of NETWARE). With the older version (NETWARE 3), each server manages its resources on its own and is independent. A user must be managed on each server separately. In the case of NDS-based versions, all resources in the network are managed together in the NDS (NOVELL DIRECTORY SERVICE). The user must log into the network only once and is given access to the resources according to his/her access rights. The individual resources and users are managed as objects in a hierarchical tree (NDS TREE). The position of the object in the tree is referred to as "CONTEXT" with NETWARE and must be known for access to the resources.

4.11.2 MICROSOFT Network

In case of a MICROSOFT network, data can be exchanged both between workstations (peer to peer) and between workstations and servers. The latter can supply access to files and connection to the printers. On a server, data is organized in directories as under DOS and mapped to the workstation as virtual drives. A virtual drive behaves like an additional hard disk on the workstation, and the data can be edited accordingly. Network printers can also be addressed like normal printers. A connection is possible to DOS, WINDOWS FOR WORKGROUPS, WINDOWS95/98/ME, WINDOWS NT/XP.

4.11.3 Remote Data Transfer with TCP/IP Services

The protocol TCP/IP allows the transfer of files between different computer systems. This requires a program running on the two computers that controls this data transfer. It is not necessary that the same operating or file system is used by both computers. For example, a file transfer between DOS/WINDOWS and UNIX is possible. One of the two partners must be configured as Host and the other one as Client. However, they may change their roles. Usually, the system which is able to perform several processes at the same time will play the host role. The file transfer program usually used under TCP/IP is FTP (File Transfer Protocol). An FTP host is installed as standard on the majority of UNIX systems.

If the TCP/IP services are installed, a terminal connection is possible using *Start - Programs - Accessories - Telnet* or a data transfer via FTP by means of *Start - Run ftp - OK*. Thus all computer systems supporting these universal protocols can be addressed (UNIX, VMS, etc.).

For further information, refer to the corresponding XP literature.

File Transfer via FTP

The total scope of functions and commands is described in the FTP literature. The following table therefore only contains the major functions:

Setting up the connection

- Click *Start* and then *Run* in the task bar.
- The DOS command `FTP` starts the program.
- The command `OPEN <xx.xx.xx.xx>` sets up the connection. (xx.xx.xx.xx = IP address e.g. 89.0.0.13)

Data transfer

- The command `PUT <file name>` transfers the data to the target system.
- The command `GET <file name>` transfers the data from the target system.
- The command `TYPE B` transfers the data in BINARY format; no conversion takes place.
- The command `TYPE A` transfers the data in ASCII format, converting control characters so that text files can also be read on the target system.

Examples

```
PUT C:\AUTOEXEC.BAT
```

sends the file `AUTOEXEC.BAT` to the target system.

```
LCD DATA
```

changes the current directory on the local machine to subdirectory `DATA`

```
CD SETTING
```

changes to the subdirectory `SETTING` on the target system

file name = file name e.g. `DATA.TXT`

Changing the directories

- The command `LCD <path>` changes the directory on the local machine as with DOS.
- The command `LDIR` shows the directory contents on the local machine.

These commands refer to the file system of the R&S ESCI. If the “L” is omitted ahead of the commands, they apply to the target system.

4.12 RSIB Protocol

The instrument is equipped with an RSIB protocol as standard, which allows the instrument to be controlled by means of Visual C++ and Visual Basic programs, but also by means of the Windows applications WinWord and Excel as well as National Instruments LabView, LabWindows/CVI and Agilent VEE. The control applications run on an external computer in the network.

A UNIX operating system can be installed on an external computer in addition to a Windows operating system. In this case, the control applications are created either in C or C++. The supported UNIX operating systems include:

- Sun Solaris 2.6 Sparc Station
- Sun Solaris 2.6 Intel Platform
- Red Hat Linux 6.2 x86 Processors

4.12.1 Remote Control via RSIB Protocol

4.12.1.1 Windows Environment

To access the measuring instruments via the RSIB protocol, the file `RSIB32.DLL` must be copied to the Windows `system32` directory or to the directory of the control applications. For 16-bit applications, the file `RSIB.DLL` must be additionally copied to the directories mentioned. The files `RSIB.DLL` and `RSIB32.DLL` are included on the instrument in directory `D:\R_S\Instr\RSIB`.

For the different programming languages, there are files available that contain the declarations of the DLL functions and the definition of the error codes.

Visual Basic (16 bit):	'RSIB.BAS'	(D:\R_S\Instr\RSIB)
Visual Basic (32 bit):	'RSIB32.BAS'	(D:\R_S\Instr\RSIB)
C/C++:	'RSIB.H'	(D:\R_S\Instr\RSIB)

For C/C++: programs, import libraries are additionally available.

Import library for RSIB.DLL:	<code>RSIB.LIB'</code>	(D:\R_S\Instr\RSIB)
Import library for RSIB32.DLL:	<code>RSIB32.LIB'</code>	(D:\R_S\Instr\RSIB)

The control is performed using the Visual C++ or Visual Basic programs WinWord, Excel, LabView, LabWindows/CVI or Agilent VEE. Every application that can load a DLL is able to use the RSIB protocol. The programs use the IP address of the instrument or its *host name* to set up the connection.

Via VisualBasic:

```
ud = RSDLLibfind ("82.1.1.200", ibsta, iberr, ibcntl)
```

Return to manual operation is possible via the front panel (*LOCAL* key) or via the RSIB protocol:

Via RSIB:

```
ud = RSDLLibloc (ud, ibsta, iberr, ibcntl);
or
ud = RSDLLibonl (ud, 0, ibsta, iberr, ibcntl);
```

4.12.1.2 UNIX Environment

To access the measuring equipment via the RSIB interface, copy the `librsib.so.X.Y` file to a directory for which the control application has read rights. `X.Y` in the file name indicates the version number of the library, for example 1.0.

The `librsib.so.X.Y` library is created as a *shared library*. The applications using the library need not consider its version. They simply link the library with the `lrsib` option. The following instructions have to be observed so that linking can be successfully performed and the library can be found during program execution:

File link:

- Use the operating system command `ln` to create a file with the link name `librsib.so` and pointing to `librsib.so.X.Y` in a directory for which the control application has read rights. Example:

```
$ ln -s /usr/lib/librsib.so.1.0 /usr/lib/librsib.so
```

Linker options for creating applications:

- `-lrsib`: import library
- `-Lxxx`: path information where the import library can be found. This is where the above file link has been created. Example: `-L/usr/lib`.

Additional linker options for creating applications (only under Solaris):

- `-Rxxx`: path information where the library is searched for during the program run: `-R/usr/lib`.

Run-time environment:

- Set environment variable `LD_RUN_PATH` to the directory in which the file link has been created. This is necessary only if `librsib.so` cannot be found in the default search path of the operating system and the `-R` linker option (only Solaris) was not specified.

For C/C++ programming, the declarations of the library functions and the definition of error codes are contained in:

```
C/C++:          'RSIB.H'          (D:\R_S\Instr\RSIB)
```

4.13 RSIB Interface Functions

This section lists all functions of the DLL "RSIB.DLL" or "RSIB32.DLL" or "librsib.so", which allow control applications to be produced.

4.13.1 Overview of Interface Functions

The library functions are adapted to the interface functions of National Instruments for GPIB programming. The functions supported by the libraries are listed in the following table.

Function	Description
RSDLLibfind()	Provides a handle for access to a device.
RSDLLibwrt()	Sends a zero-terminated string to a device.
RSDLLiwrft()	Sends a certain number of bytes to a device.
RSDLLibrwrtf()	Sends the contents of a file to a device.
RSDLLibrd()	Reads data from a device into a string.
RSDLLird()	Reads a certain number of bytes from a device.
RSDLLibrdf()	Reads data from a device into a file.
RSDLLibtmo()	Sets time-out for RSIB functions.
RSDLLibsre()	Switches a device to the local or remote state.
RSDLLibloc()	Temporarily switches a device to the local state.
RSDLLibeot()	Enables/disables the END message for write operations.
RSDLLibrsp()	Performs a serial poll and provides the status byte.
RSDLLibonl()	Sets the device online/offline.
RSDLLTestSRQ()	Checks whether a device has generated an SRQ.
RSDLLWaitSrq()	Waits until a device generates an SRQ.
RSDLLSwapBytes	Swaps the byte sequence for binary numeric display (only required for non-Intel platforms).

4.13.1.1 Variables *ibsta*, *iberr*, *ibcntl*

As with the National Instrument interface, the successful execution of a command can be checked by means of the variables *ibsta*, *iberr* and *ibcntl*. For this purpose, all RSIB functions are assigned references to these three variables.

Status word - *ibsta*

The status word *ibsta* provides information on the status of the RSIB interface. The following bits are defined:

Bit designation	Bit	Hex code	Description
ERR	15	8000	Is set when an error has occurred on calling a function. If this bit is set, <i>iberr</i> contains an error code that specifies the error in greater detail.
TIMO	14	4000	Is set when a time-out has occurred on calling a function.

Bit designation	Bit	Hex code	Description
CMPL	8	0100	Is set if the response of the GPIB parser has been read out completely. If a parser response is read out with the function <code>RSDLLibIrd()</code> and the length of the buffer is insufficient for the answer, the bit will be cleared.

Error variable - `iberr`

If the ERR bit (8000h) is set in the status word, `iberr` contains an error code which allows the error to be specified in greater detail. Extra error codes are defined for the RSIB protocol, independent of the National Instruments interface.

Error	Error code	Description
IBERR_CONNECT	2	Setup of the connection to the measuring instrument has failed.
IBERR_NO_DEVICE	3	A function of the interface has been called with an illegal device handle.
IBERR_MEM	4	No empty memory available.
IBERR_TIMEOUT	5	Time-out has occurred.
IBERR_BUSY	6	The RSIB protocol is blocked by a function that is still running.
IBERR_FILE	7	Error when reading or writing to a file.
IBERR_SEMA	8	Error upon creating or assigning a semaphore (only under UNIX).

Count variable - `ibcntl`

The variable `ibcntl` is updated with the number of transferred bytes each time a read or write function is called.

4.13.1.2 Description of Interface Functions

RSDLLibfind()

The function provides a handle for access to the device with the name `udName`.

VB format: `Function RSDLLibfind (ByVal udName$, ibsta%, iberr%, ibcntl&) As Integer`

C format: `short WINAPI RSDLLibfind(char far *udName, short far *ibsta, short far *iberr, unsigned long far *ibcntl)`

C format (UNIX): `short RSDLLibfind(char *udName, short *ibsta, short *iberr, unsigned long *ibcntl)`

Parameters: `udName` IP address of device

Example: `ud = RSDLLibfind ("89.10.38.97", ibsta, iberr, ibcntl)`

The function must be called prior to all other functions of the interface.

As return value, the function provides a handle that must be indicated in all functions for access to the device. If the device with the name `udName` is not found, the handle has a negative value.

RSDLLibwrt

This function sends data to the device with the handle `ud`.

VB format: `Function RSDLLibwrt (ByVal ud%, ByVal Wrt$, ibsta%, iberr%, ibcntl&) As Integer`

C format: `short WINAPI RSDLLibwrt(short ud, char far *Wrt, short far *ibsta, short far *iberr, unsigned long far *ibcntl)`

C format (UNIX): `short RSDLLibwrt(short ud, char *Wrt, short *ibsta, short *iberr, unsigned long *ibcntl)`

Parameters:

<code>ud</code>	Device handle
<code>Wrt</code>	String sent to the device.

Example: `RSDLLibwrt(ud, "SENS:FREQ:STAR?", ibsta, iberr, ibcntl)`

This function allows setting and query commands to be sent to the measuring instruments. Whether the data is interpreted as a complete command can be set using the function `RSDLLibeot()`.

RSDLLilwrt

This function sends `Cnt` bytes to a device with the handle `ud`.

VB format: `Function RSDLLilwrt (ByVal ud%, ByVal Wrt$, ByVal Cnt&, ibsta%, iberr%, ibcntl&) As Integer`

C format: `short WINAPI RSDLLilwrt(short ud, char far *Wrt, unsigned long Cnt, short far *ibsta, short far *iberr, unsigned long far *ibcntl)`

C format (UNIX): `short RSDLLilwrt(short ud, char *Wrt, unsigned long Cnt, short *ibsta, short *iberr, unsigned long *ibcntl)`

Parameters:

<code>ud</code>	Device handle
<code>Wrt</code>	String sent to the GPIB parser.
<code>Cnt</code>	Number of bytes sent to the device.

Example: `RSDLLilwrt (ud, '.....', 100, ibsta, iberr, ibcntl)`

Like `RSDLLibwrt()` this function sends data to a device. The only difference is that binary data can be sent as well. The length of the data is not determined by a zero-terminated string, but by the indication of `Cnt` bytes. If the data is to be terminated with EOS (0Ah), the EOS byte must be appended to the string.

RSDLLibwrtf

This function sends the contents of a file\$ file to the device with the handle ud.

VB format: Function RSDLLibwrtf (ByVal ud%, ByVal file\$, ibsta%, iberr%, ibcntl&) As Integer

C format: short WINAPI RSDLLibwrt(short ud, char far *Wrt, short far *ibsta, short far *iberr, unsigned long far *ibcntl)

C format (UNIX): short RSDLLibwrt(short ud, char *Wrt, short *ibsta, short *iberr, unsigned long *ibcntl)

Parameters:

ud	Device handle
file	File whose contents is sent to the device.

Example: RSDLLibwrtf(ud, "C:\db.sav", ibsta, iberr, ibcntl)

This function allows setting and query commands to be sent to the measuring instruments. Whether the data is interpreted as a complete command can be set using the function RSDLLibeot().

RSDLLibrd()

The function reads data from the device with the handle ud into the string Rd.

VB format: Function RSDLLibrd (ByVal ud%, ByVal Rd\$, ibsta%, iberr%, ibcntl&) As Integer

C format: short WINAPI RSDLLibrd(short ud, char far *Rd, short far *ibsta, short far *iberr, unsigned long far *ibcntl)

C format (UNIX): short RSDLLibrd(short ud, char *Rd, short *ibsta, short *iberr, unsigned long *ibcntl)

Parameters:

ud	Device handle
Rd	String to which the read data is copied.

Example: RSDLLibrd (ud, Rd, ibsta, iberr, ibcntl)

This function fetches the responses of the GPIB parser to a query.

In the case of Visual Basic programming, a string of sufficient length must be generated beforehand. This can be done during the definition of the string or using the command Space\$().

Generation of a string of the length 100:

```
- Dim Rd as String * 100
- Dim Rd as String
  Rd = Space$(100)
```

RSDLLilrd

This function reads `Cnt` bytes from the device with the handle `ud`.

VB format: Function `RSDLLilrd` (ByVal `ud%`, ByVal `Rd$`, ByVal `Cnt&`, `ibsta%`, `iberr%`, `ibcntl&`) As Integer

C format: `short WINAPI RSDLLilrd(short ud, char far *Rd, unsigned long Cnt, short far *ibsta, short far *iberr, unsigned long far *ibcntl)`

C format (UNIX): `short RSDLLilrd(short ud, char *Rd, unsigned long Cnt, short *ibsta, short *iberr, unsigned long *ibcntl)`

Parameters:

<code>ud</code>	Device handle
<code>cnt</code>	Maximum number of bytes copied from the DLL into the target string <code>Rd</code> .

Example: `RSDLLilrd (ud, RD, 100, ibsta, iberr, ibcntl)`

Like the function `RSDLLibrd()`, this function reads data from a device. The only difference is that in this case the maximum number of bytes to be copied to the target string `Rd` can be indicated by means of `Cnt`. This function prevents writing beyond the end of the string.

RSDLLibrdf()

Reads data from the device with the handle `ud` into the file `file`.

VB format: Function `RSDLLibrdf` (ByVal `ud%`, ByVal `file$`, `ibsta%`, `iberr%`, `ibcntl&`) As Integer

C format: `short WINAPI RSDLLibrdf(short ud, char far *file, short far *ibsta, short far *iberr, unsigned long far *ibcntl)`

C format (UNIX): `short RSDLLibrdf(short ud, char *file, short *ibsta, short *iberr, unsigned long *ibcntl)`

Parameters:

<code>ud</code>	Device handle
<code>file</code>	File to which the read data is written.

Example: `RSDLLibrdf (ud, "c:\db.sav", ibsta, iberr, ibcntl)`

The file name may as well include a drive or path specification.

RSDLLibtmo

This function defines the time-out for a device. The default value for the time-out is set to 5 seconds.

VB format: Function RSDLLibtmo (ByVal ud%, ByVal tmo%,
ibsta%, iberr%, ibcntl&) As Integer

C format: void WINAPI RSDLLibtmo(short ud, short tmo,
short far *ibsta, short far *iberr, unsigned
long far *ibcntl)

C format (UNIX): short RSDLLibtmo(short ud, short tmo, short
*ibsta, short *iberr, unsigned long *ibcntl
)

Parameters: ud Device handle
tmo Time-out in seconds

Example: RSDLLibtmo (ud, 10, ibsta, iberr, ibcntl)

RSDLLibsre

This function sets the device to the 'LOCAL' or 'REMOTE' state.

VB format: Function RSDLLibsre (ByVal ud%, ByVal v%,
ibsta%, iberr%, ibcntl&) As Integer

C format: void WINAPI RSDLLibsre(short ud, short v,
short far *ibsta, short far *iberr, unsigned
long far *ibcntl)

C format (UNIX): short RSDLLibsre(short ud, short v, short
*ibsta, short *iberr, unsigned long
*ibcntl)

Parameters: ud Device handle
v State of device
 0 - local
 1 - remote

Example: RSDLLibsre (ud, 0, ibsta, iberr, ibcntl)

RSDLLibloc

This function temporarily switches the device to the 'LOCAL' state.

VB format: Function RSDLLibloc (ByVal ud%, ibsta%,
iberr%, ibcntl&) As Integer

C format: void WINAPI RSDLLibloc(short ud, short far
*ibsta, short far *iberr, unsigned long far
*ibcntl)

C format (UNIX): short RSDLLibloc(short ud, short *ibsta,
short *iberr, unsigned long *ibcntl)

Parameter: ud Device handle

Example: RSDLLibloc (ud, ibsta, iberr, ibcntl)

After switch over to LOCAL state, the instrument can be manually operated via the front panel. On the next access to the instrument by means of one of the functions of the library, the instrument is switched again to the REMOTE state.

RSDLLibeot

This function enables or disables the END message after write operations.

VB format: Function RSDLLibeot (ByVal ud%, ByVal v%,
 ibsta%, iberr%, ibcntl&) As Integer

C format: void WINAPI RSDLLibsre(short ud, short v,
 short far *ibsta, short far *iberr, unsigned
 long far *ibcntl)

C format (UNIX): short RSDLLibsre(short ud, short v, short
 *ibsta, short *iberr, unsigned long
 *ibcntl)

Parameters: ud Device handle
 v 0 - no END message 1 – send END
 message

Example: RSDLLibeot (ud, 1, ibsta, iberr, ibcntl)

If the END message is disabled, the data of a command can be sent with several successive calls of write functions. The END message must be enabled again before sending the last data block.

RSDLLibrsp

This function performs a serial poll and provides the status byte of the device.

VB format: Function RSDLLibrsp(ByVal ud%, spr%,
 ibsta%, iberr%, ibcntl&) As Integer

C format: void WINAPI RSDLLibrsp(short ud, char far*
 spr, short far *ibsta, short far *iberr,
 unsigned long far *ibcntl)

C format (UNIX): short RSDLLibrsp(short ud, char *spr,
 short *ibsta, short *iberr, unsigned long
 *ibcntl)

Parameters: ud Device handle
 spr Pointer to status byte

Example: RSDLLibrsp(ud, spr, ibsta, iberr, ibcntl)

RSDLLibonl

This function switches the device to 'online' or 'offline' mode. When it is switched to 'offline' mode, the interface is released and the device handle becomes invalid. By calling RSDLLibfind again, the communication is set up again.

VB format: Function RSDLLibonl (ByVal ud%, ByVal v%,
ibsta%, iberr%, ibcntl&) As Integer

C format: void WINAPI RSDLLibonl(short ud, short v,
short far *ibsta, short far *iberr,
unsigned long far *ibcntl)

C format: short RSDLLibonl(short ud, short v, short
*ibsta, short *iberr, unsigned long
*ibcntl)

Parameters:

ud	Device handle
v	Device state
	0 - local
	1 - remote

Example: RSDLLibonl(ud, 0, ibsta, iberr, ibcntl)

RSDLLTestSRQ

This function checks the status of the SRQ bit.

VB format: Function RSDLLTestSrq (ByVal ud%, Result%,
ibsta%, iberr%, ibcntl&) As Integer

C format: void WINAPI RSDLLTestSrq(short ud, short
far *result, short far *ibsta, short far
*iberr, unsigned long far *ibcntl)

C format (UNIX): short RSDLLTestSrq(short ud, short
*result, short *ibsta, short *iberr,
unsigned long *ibcntl)

Parameters:

ud	Device handle
result	Reference to an integer value in which the library returns the status of the SRQ bit
	0 - no SRQ
	1 - SRQ active, device requests ser- vice

Example: RSDLLTestSrq (ud, result%, ibsta, iberr,
ibcntl)

This function corresponds to the function RSDLLWaitSrq. The only difference is that RSDLLTestSRQ immediately returns the current status of the SRQ bit, whereas RSDLLWaitSrq waits for an SRQ to occur.

RSDLLWaitSrq

This function waits until the device triggers an SRQ with the handle `ud`.

VB format: Function RSDLLWaitSrq (ByVal ud%, Result%,
 ibsta%, iberr%, ibcntl&) As Integer

C format: void WINAPI RSDLLWaitSrq(short ud, short
 far *result, short far *ibsta, short far
 *iberr, unsigned long far *ibcntl)

C format (UNIX): short RSDLLWaitSrq(short ud, short
 *result, short *ibsta, short *iberr,
 unsigned long *ibcntl)

Parameters: ud Device handle
 result Reference to an integer value in which
 the library returns the status of the
 SRQ bit
 0 - No SRQ occurred during the time-
 out
 1 - SRQ occurred during the time-out

Example: RSDLLWaitSrq(ud, result, ibsta, iberr,
 ibcntl);

The function waits until one of the following two events occurs.

- The measuring instrument triggers an SRQ.
- No SRQ occurs during the time-out defined with `RSDLLibtmo()`.

RSDLLSwapBytes

This function changes the display of binary numbers on non-Intel platforms.

VB format: Not provided at present since it is
 required only on non-Intel platforms.

C format: void WINAPI RSDLLSwapBytes(void far
 *pArray, const long size, const long count)

C format (UNIX): void RSDLLSwapBytes(void *pArray, const
 long size, const long count)

Parameters: pArray Array in which modifications are made
 size Size of a single element in pArray
 count Number of elements in pArray

Example: RSDLLSwapBytes(Buffer, sizeof(float),
 ibcntl/sizeof(float))

This function swaps the display of various elements from *Big Endian* to *Little Endian* and vice versa. It is expected that a coherent storage area of elements of the same file type (`size` byte) is transferred to `pArray`. This function has no effect on Intel platforms.

Different types of processor architecture store data in different byte sequences. For example, Intel processors store data in the reverse order of Motorola processors. Comparison of byte sequences:

Byte sequence	Use in	Display in memory	Description
Big Endian	Motorola processors, network standard	Most significant byte at least significant address	The <i>most significant</i> byte is at the left end of the word.
Little Endian	Intel processors	Least significant byte at least significant address	The <i>most significant</i> byte is at the right end of the word.

4.13.2 Programming via the RSIB Protocol

4.13.2.1 Visual Basic

Programming tips

Access to the functions of the RSIB.DLL

To create Visual Basic control applications, the file RSIB.BAS must be added to a project for 16-bit Basic programs and the file RSIB32.BAS for 32-bit Basic programs (D:\R_S\INSTR\RSIB) so that the functions of the RSIB.DLL or RSIB32.DLL can be accessed.

Generating a response buffer

Prior to calling the functions `RSDLLibrd()` and `RSDLLilrd()`, a string of sufficient length must be generated. This is possible either by defining the string or using the command `Space$()`.

Generating a string of the length 100:

```
- Dim Response as String * 100
- Dim Response as String
  Response = Space$(100)
```

If a response is to be output as a string from the measuring instrument, the appended blanks can be removed using the Visual Basic Function `RTrim()`.

Example:

```
Response = Space$(100)
Call RSDLLibrd(ud, Response, ibsta, iberr, ibcntl)
Response = RTrim(Response)
' Output of Response
```

Reading out trace data in real format

Using the function declarations in the file RSIB.BAS or RSIB32.BAS the responses of the device can be assigned to one string only. If the data are to be read into an array with float values, the header and the useful data must be read out with separate function calls.

Example of a header

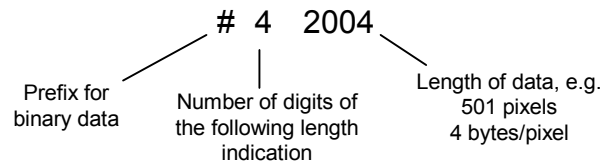

In order to enable the trace data to be directly read into a float array, a special function declaration must be created.

```
Declare Function RSDLLilrdTraceReal Lib "rsib32.dll" Alias "RSDLLilrd" (ByVal ud%, Rd As Single, ByVal Cnt&, ibsta%, iberr%, ibcntl&) As Integer
```

Example

```
Dim ibsta As Integer
' Status variable
Dim iberr As Integer
' Error variable
Dim ibcntl As Long
' Count variable
Dim ud As Integer
' Handle for measuring instrument
Dim Result As String
' Buffer for simple results
Dim Digits As Byte
' Number of digits of length indication
Dim TraceBytes As Long
' Length of trace data in bytes
Dim TraceData(501) As Single
' Buffer for floating point Binary data

' Set up connection to instrument
ud = RSDLLibfind("89.10.38.97", ibsta, iberr, ibcntl)

' Query trace data in real format
Call RSDLLibwrt(ud, "FORM:DATA REAL,32", ibsta, iberr, ibcntl)
Call RSDLLibwrt(ud, "TRACE? TRACE1", ibsta, iberr, ibcntl)

' Read number of digits of length indication
Result = Space$(20)
Call RSDLLilrd(ud, Result, 2, ibsta, iberr, ibcntl)
Digits = Val(Mid$(Result, 2, 1))

' Read length indication
Result = Space$(20)
Call RSDLLilrd(ud, Result, Digits, ibsta, iberr, ibcntl)
TraceBytes = Val(Left$(Result, Digits))
```



```

        'and store

        ' Read out trace data
Call RSDLLilrdTraceReal(ud, TraceData(0), TraceBytes, ibsta, iberr,ibcntl)

```

Programming examples

In this example, the start frequency of the instrument is queried.

```

Dim ibsta As Integer
        ' Status variable
Dim iberr As Integer
        ' Error variable
Dim ibcntl As Long
        ' Count variable
Dim ud As Integer
        ' Handle for measuring instrument
Dim Response As String
        ' Response string

        ' Set up connection to measuring instrument
ud = RSDLLibfind("89.10.38.97", ibsta, iberr, ibcntl)
If (ud < 0) Then
        ' Error treatment
End If

        ' Send query command
Call RSDLLibwrt(ud, "FREQ:START?", ibsta, iberr, ibcntl)

        ' Provide space for response
Response = Space$(100)

        ' Read response from measuring instrument
Call RSDLLibrd(ud, Response, ibsta, iberr, ibcntl)

```

In this example, a Save/Recall of the instrument setups is performed.

```

Dim ibsta As Integer
        ' Status variable
Dim iberr As Integer
        ' Error variable
Dim ibcntl As Long
        ' Count variable
Dim ud As Integer
        ' Handle for measuring instrument
Dim Cmd As String
        ' Command string

```

```

        ' Set up connection to measuring instrument
ud = RSDLLibfind("89.10.38.97", ibsta, iberr, ibcntl)
If (ud < 0) Then
        ' Error treatment
End If

        ' Request instrument settings
Cmd = "SYST:SET?"
Call RSDLLibwrt(ud, Cmd, ibsta, iberr, ibcntl)

        ' Store instrument response in file
Call RSDLLibrdf(ud, "C:\db.sav", ibsta, iberr, ibcntl)

        ' Reset instrument
Call RSDLLibwrt(ud, "*RST", ibsta, iberr, ibcntl)

        ' and restore the previous settings
        ' to this end disable the END message
Call RSDLLibeot(ud, 0, ibsta, iberr, ibcntl)
        ' first send off command
Call RSDLLibwrt(ud, "SYST:SET ", ibsta, iberr, ibcntl)
        ' enable the END message again
Call RSDLLibeot(ud, 1, ibsta, iberr, ibcntl)
        ' and send the data
Call RSDLLibwrtf(ud, "C:\db.sav", ibsta, iberr, ibcntl)

```

4.13.2.2 Visual Basic for Applications (Winword and Excel)

Programming tips

The programming language Visual Basic for Applications (VBA) is supported as a macro language by various manufacturers. The programs Winword and Excel use this language for the versions Winword 97 or Excel 5.0 and higher.

For macros created with Visual Basic for Applications, the same tips are valid as for Visual Basic Applications.

Programming example

Using the macro `QueryMaxPeak`, a single sweep with subsequent query of the maximum peak is performed. The result is entered in a Winword or Excel document.

```

Sub QueryMaxPeak()
    Dim ibsta As Integer
        ' Status variable
    Dim iberr As Integer
        ' Error variable
    Dim ibcntl As Long
        ' transferred characters
    Dim ud As Integer
        ' Unit Descriptor (handle) for instrument
    Dim Response As String
        ' Response string

```

```

        ' Set up connection to measuring instrument
ud = RSDLLibfind("89.10.38.97", ibsta, iberr, ibcntl)
If (ud < 0) Then
    Call MsgBox("Device with address 89.10.38.97 could" & _
        "not be found", vbExclamation)
    End
End If

        ' Determine maximum peak in the range 1-2MHZ
Call RSDLLibwrt(ud, "*RST", ibsta, iberr, ibcntl)
Call RSDLLibwrt(ud, "INIT:CONT OFF", ibsta, iberr, ibcntl)
Call RSDLLibwrt(ud, "FREQ:START 1MHZ", ibsta, iberr, ibcntl)
Call RSDLLibwrt(ud, "FREQ:STOP 2MHZ", ibsta, iberr, ibcntl)
Call RSDLLibwrt(ud, "INIT:IMM;*WAI", ibsta, iberr, ibcntl)
Call RSDLLibwrt(ud, "CALC:MARK:MAX;Y?", ibsta, iberr, ibcntl)
Response = Space$(100)
Call RSDLLibrd(ud, Response, ibsta, iberr, ibcntl)
Response = RTrim(Response)
        ' Cut off space

        ' Insert value in current document (Winword)
Selection.InsertBefore (Response)
Selection.Collapse (wdCollapseEnd)

        ' Terminate connection to measuring instrument
Call RSDLLibonl(ud, 0, ibsta, iberr, ibcntl)
End Sub

```

The entry of the peak value in the Winword document can be replaced as follows for Excel:

```

' Insert value in current document (Excel)
ActiveCell.FormulaR1C1 = Response

```

4.13.2.3 C / C++

Programming tips

Access to the functions of the RSIB32.DLL (Windows platforms)

The functions of the RSIB32.DLL are declared in the header file RSIB.H. The DLL functions can be linked to a C/C++ program in different ways.

- Enter one of the supplied import libraries (RSIB.LIB or RSIB32.LIB) into the linker options.
- Load the library using the function `LoadLibrary()` during runtime and determine the function pointers of the DLL functions using `GetProcAddress()`. Before the end of the program, the RSIB.DLL must be unloaded again using the function `FreeLibrary()`.

When import libraries are used, the DLL is automatically loaded immediately before the application is started. At the end of the program, the DLL is unloaded again unless it is still used by other applications.

Access to librsib.so functions (UNIX platforms)

The functions of `librsib.so` are declared in the header file `RSIB.H`. Uppercase/lowercase characters for file names are typically observed under UNIX. The library functions are linked to a C/C++ program by entering the `-lrsib` linker option.

The *shared library* `librsib.so` is automatically loaded on starting the application. The accessibility (for example via standard path) of the library must be ensured. Refer to section ["UNIX Environment" on page 4.319](#).

Query of strings

If instrument responses are to be further processed as strings, a zero termination must be appended.

Example

```
char buffer[100];
...
RSDLLibrd( ud, buffer, &ibsta, &iberr, &ibcntl );
buffer[ibcntl] = 0;
```

Programming example

In the following C program example, a single sweep is started on the device with the IP address 89.10.38.97 and subsequently a marker is set to maximum level. Prior to the search for maximum, a synchronization to the end of the sweep is performed. For this purpose the command `"*OPC"` (Operation complete) is used to create a service request at the end of the sweep, for which the control program waits with the function `RSDLLWaitSrq()`. Then the maximum is determined (`"CALC:MARK:MAX"`) and the level read out (`"Y?"`).

```
#define MAX_RESP_LEN 100

short      ibsta, iberr;
unsigned long  ibcntl;
short      ud;
short      srq;
char      MaxPegel[MAX_RESP_LEN];
char      spr;

// Determine handle for instrument
ud = RSDLLibfind( "89.10.38.97", &ibsta, &iberr, &ibcntl );

// if instrument exists
if ( ud >= 0 )
{
    // Set timeout for RSDLLWaitSrq() to 10 seconds
    RSDLLibtmo( ud, 10, &ibsta, &iberr, &ibcntl );
```

```
// Activate SRQ generation via event status register (ESR)
// and enable ESB bit in SRE register
RSDLLibwrt( ud, "*ESE 1;*SRE 32", &ibsta, &iberr, &ibcntl );

// Set single sweep, trigger sweep and use "*OPC" to cause
// the generation of a service request at the end of the sweep
RSDLLibwrt( ud, "INIT:CONT off;INIT;*OPC", &ibsta, &iberr, &ibcntl );

// Wait for SRQ (end of sweep)
RSDLLWaitSrq( ud, &srq, &ibsta, &iberr, &ibcntl );

// Clear RQS/MSS bit
RSDLLibrsp( ud, &spr, &ibsta, &iberr, &ibcntl );

// if sweep is terminated
if (srq)
{
    // then set marker to first maximum and query the level
    RSDLLibwrt( ud, "CALC:MARK:MAX;Y?", &ibsta, &iberr, &ibcntl );
    RSDLLilrd( ud, MaxPegel, MAX_RESP_LEN, &ibsta, &iberr, &ibcntl );
    MaxPegel[ibcntl] = 0;
}
// End connection to instrument
RSDLLibonl (ud, 0, &ibsta, &iberr, &ibcntl ) ;
}
else
{
    ; // Error Instrument not found
}
```

5 Remote Control – Basics

5.1 Overview	5.3
5.2 Introduction	5.3
5.3 Getting Started	5.3
5.4 Starting Remote Control	5.4
5.4.1 Display Contents during Remote Control	5.4
5.4.2 Remote Control via GPIB	5.5
5.4.2.1 Setting the Device Address	5.5
5.4.2.2 Return to Manual Operation	5.5
5.4.3 Remote Control via RS-232-Interface	5.6
5.4.3.1 Setting the Transmission Parameters	5.6
5.4.3.2 Return to Manual Operation	5.6
5.4.3.3 Restrictions	5.6
5.4.4 Remote Control in a Network (LAN Interface)	5.7
5.4.4.1 Setting the Device Address	5.7
5.4.4.2 Return to Manual Operation	5.7
5.5 Messages	5.8
5.5.1 GPIB Interface Messages	5.8
5.5.2 Device Messages (Commands and Device Responses)	5.8
5.6 Structure and Syntax of the Device Messages	5.9
5.6.1 SCPI Introduction	5.9
5.6.2 Structure of a Command	5.9
5.6.3 Structure of a Command Line	5.11
5.6.4 Responses to Queries	5.12
5.6.5 Parameters	5.13
5.6.6 Overview of Syntax Elements	5.15
5.6.7 Instrument Model and Command Processing	5.15
5.6.8 Input Unit	5.16
5.6.9 Command Recognition	5.16
5.6.10 Instrument Data Base and Instrument Hardware	5.17
5.6.11 Status Reporting System	5.17
5.6.12 Output Unit	5.17
5.6.13 Command Sequence and Command Synchronization	5.17
5.7 Status Reporting System	5.18
5.7.1 Structure of an SCPI Status Register	5.18
5.7.2 Overview of the Status Registers	5.21

5.7.3 Description of the Status Registers	5.22
5.7.3.1 Status Byte (STB) and Service Request Enable Register (SRE)	5.22
5.7.3.2 IST Flag and Parallel Poll Enable Register (PPE)	5.23
5.7.3.3 Event-Status Register (ESR) and Event-Status-Enable Register (ESE)	5.23
5.7.3.4 STATUS:OPERation Register	5.24
5.7.3.5 STATUS:QUEStionable Register	5.25
5.7.3.6 STATUS:QUEStionable:ACPLimit Register	5.26
5.7.3.7 STATUS:QUEStionable:FREQuency Register	5.27
5.7.3.8 STATUS:QUEStionable:LIMit<1 2> Register	5.27
5.7.3.9 STATUS:QUEStionable:LMARgin<1 2> Register	5.28
5.7.3.10 STATUS:QUEStionable:POWER Register	5.28
5.7.3.11 STATUS:QUEStionable:TRANsducer Register	5.29
5.7.4 Application of the Status Reporting Systems	5.30
5.7.4.1 Service Request, Making Use of the Hierarchy Structure	5.30
5.7.4.2 Serial Poll	5.30
5.7.4.3 Parallel Poll	5.30
5.7.4.4 Query by Means of Commands	5.31
5.7.4.5 Error Queue Query	5.31
5.7.5 Resetting Values of the Status Reporting System	5.31

5.1 Overview

This chapter contains the following:

- instructions on how to put the R&S ESCI into operation via remote control,
- a general introduction to remote control of programmable instruments. This includes the description of the command structure and syntax according to the SCPI standard, the description of command execution and of the status registers,
- diagrams and tables describing the status registers used in the R&S ESCI.

In chapter [“Remote Control – Description of Commands”](#), all remote control functions are described in detail. The subsystems are listed by alphabetical order according to SCPI.

Program examples for the R&S ESCI can be found in chapter [“Remote Control – Programming Examples”](#). The remote control interfaces and their interface functions are described in chapter [“Maintenance and Instrument Interfaces”](#).

5.2 Introduction

The instrument is equipped with an GPIB interface according to standard IEC 625.1/ IEEE 488.2 and an RS-232 interface. The connectors are located at the rear of the instrument and permit to connect a controller for remote control.

In addition, the instrument can be remotely controlled in a local area network (LAN interface).

The instrument supports the SCPI version 1997.0 (Standard Commands for Programmable Instruments). The SCPI standard is based on standard IEEE 488.2 and aims at the standardization of device-specific commands, error handling and the status registers (see section [“SCPI Introduction” on page 5.9](#)).

The tutorial "Automatic Measurement Control – A tutorial on SCPI and IEEE 488.2" from John M. Pieper (R&S order number 0002.3536.00) offers detailed information on concepts and definitions of SCPI. For remote control in a network, refer to section [“Remote Control in a Network \(LAN Interface\)” on page 5.7](#).

This section assumes basic knowledge of GPIB programming and operation of the controller. A description of the interface commands can be obtained from the relevant manuals.

The requirements of the SCPI standard placed on command syntax, error handling and configuration of the status registers are explained in detail in the following sections. Tables provide a fast overview of the bit assignment in the status registers. The tables are supplemented by a comprehensive description of the status registers.

The program examples for GPIB programming are all written in VISUAL BASIC.

5.3 Getting Started

The short and simple operating sequence provided below enables you to quickly put the instrument into operation and set its basic functions. As a prerequisite, the GPIB address, which is factory-set to 20, must remain unchanged.

1. Connect instrument and controller using GPIB cable.

2. Write and start the following program on the controller:

```
CALL IBFIND("DEV1", analyzer%)
'Open port to the instrument

CALL IBPAD(analyzer%, 20)
'Inform controller about instrument address

CALL IBWRT(analyzer%, '*RST;*CLS')
'Reset instrument

CALL IBWRT(analyzer%, 'FREQ:CENT 100MHz')
'Set center frequency to 100 MHz

CALL IBWRT(analyzer%, 'FREQ:SPAN 10MHz')
'Set span to 10 MHz

CALL IBWRT(analyzer%, 'DISP:TRAC:Y:RLEV -10dBm')
'Set reference level to -10 dBm
```

The instrument now performs a sweep in the frequency range of 95 MHz to 105 MHz in analyzer mode.

3. To return to manual operation, press the *LOCAL* key at the front panel.

5.4 Starting Remote Control

On power-on, the instrument is always in the manual operating state ("LOCAL" state) and can be operated via the front panel.

It is switched to remote control ("REMOTE" state)

GPIB	as soon as it receives an addressed command from a controller. if it is controlled in a network (RSIB interface), as soon as it receives a command from a controller.
RS-232	as soon as it receives the command "@REM" from a controller.

During remote control, operation via the front panel is disabled. The instrument remains in the remote state until it is reset to the manual state via the front panel or via remote control interfaces. Switching from manual operation to remote control and vice versa does not affect the remaining instrument settings.

5.4.1 Display Contents during Remote Control

During remote control, only the LOCAL softkey appears, with which it is possible to return to manual operation.

In addition, the display of diagrams and results can be blanked out with the command "SYSTem:DISPlay:UPDate OFF" (default in remote control) to obtain optimum performance during remote control.

During program execution it is recommended to activate the display of results by means of "SYSTem:DISPlay:UPDate ON" so that it is possible to follow the changes in the device settings and the recorded measurement curves on the screen.



If the instrument is exclusively operated in remote control, it is recommended to switch on the power-save mode (*POWER SAVE*). In this mode, the required display is completely switched off after a preset time.

5.4.2 Remote Control via GPIB

5.4.2.1 Setting the Device Address

In order to operate the instrument via the GPIB, it must be addressed using the set GPIB address. The GPIB address of the instrument is factory-set to 20. It can be changed manually in the *SETUP - GENERAL SETUP* menu or via remote control. Addresses 0 to 30 are permissible.

Manually:

1. Call *SETUP - GENERAL SETUP* menu
2. Enter desired address in table *GPIB-ADDRESS*
3. Terminate input using the *ENTER* key

Via GPIB:

```
CALL IBFIND("DEV1", analyzer%)
'Open port to the instrument

CALL IBPAD(analyzer%, 20)
'Inform controller about old address

CALL IBWRT(analyzer%, "SYST:COMM:GPIB:ADDR 18")
'Set instrument to new address

CALL IBPAD(analyzer%, 18)
'Inform controller about new address
```

5.4.2.2 Return to Manual Operation

Return to manual operation is possible via the front panel or remote control.

Manually:

Press the *LOCAL* softkey or the *PRESET* key



- Before the transition, command processing must be completed as otherwise transition to GPIB is performed immediately.
- The keys can be disabled by the universal command LLO (see chapter [“Maintenance and Instrument Interfaces”](#), section [“Interface Messages”](#) on [page 8.4](#)) in order to prevent unintentional transition. In this case, transition to manual operation is only possible via GPIB.
- The keys can be enabled again by deactivating the REN line of the GPIB (see chapter [“Maintenance and Instrument Interfaces”](#), section [“Bus Lines”](#) on [page 8.3](#)).

Via GPIB:

```
CALL IBLOC(analyzer%)
'Set instrument to manual operation
```

5.4.3 Remote Control via RS-232-Interface

5.4.3.1 Setting the Transmission Parameters

To enable an error-free and correct data transmission, the parameters of the unit and the controller should have the same setting.

Parameters can be manually changed in menu *SETUP-GENERAL SETUP* in table *COM PORT* or via remote control using the following command:

```
SYST:COMM:SER:...
```

The transmission parameters of the COM interface are factory-set to the following values:

baudrate = 9600, data bits = 8, stop bits = 1, parity = NONE and owner = INSTRUMENT.

For remote control, the interface should be allocated to the operating system (owner = OS) so that the control characters including @ can be recognized by the interface.

Manually:

Setting the COM interface

1. Call *SETUP-GENERAL SETUP* menu
2. Select desired baudrate, bits, stopbit, parity in table *COM PORT*.
3. Set owner to OS in table *COM PORT*.
4. Terminate input using the *ENTER* key.

5.4.3.2 Return to Manual Operation

Return to manual operation is possible via the front panel or via RS-232 interface.

Manually:

Press the *LOCAL* softkey or the *PRESET* key.



- Before the transition, command processing must be completed as otherwise transition to remote control is performed immediately
- The keys can be enabled again by sending the control string "@LOC" via RS-232 (see chapter "[Maintenance and Instrument Interfaces](#)", section "[RS-232-C Interface \(COM\)](#)" on page 8.6).

Via RS-232:

```
v24puts(port, "@LOC");  
Set instrument to manual operation.
```

5.4.3.3 Restrictions

The following restrictions apply if the unit is remote-controlled via the RS-232-C interface:

No interface messages, only control strings (see interface description in chapter "[Maintenance and Instrument Interfaces](#)", section "[RS-232-C Interface \(COM\)](#)" on page 8.6).

Only the Common Commands *OPC? can be used for command synchronization, *WAI and *OPC are not available.

Block data cannot be transmitted.

5.4.4 Remote Control in a Network (LAN Interface)

Via the LAN interface, the R&S ESCI can be remotely controlled in a local area network.

The LAN interface consists of a connector, a network interface card and protocols (VXI-11 and RSIB). For details on the connector and its use refer to the Quick Start Guide, chapter 1, "Front and Rear Panel".

Instrument access via VXI11 or RSIB is usually achieved from high level programming platforms by using VISA as an intermediate abstraction layer. VISA encapsulates the low level VXI, RSIB or even GPIB function calls and thus makes the transport interface transparent for the user. The necessary VISA library is available as a separate product. For details contact your local R&S sales representative.

5.4.4.1 Setting the Device Address

For control of the instrument in a network, it must be accessed using the preselected IP address. The IP address of the instrument (device address) is defined in the network configuration.

Setting the IP address:

1. Call *SETUP - GENERAL SETUP – CONFIGURE NETWORK* menu.
2. Select *Protocols* tab.
3. Under *Properties*, set IP address for TCP/IP protocol (for details refer to the Quick Start Guide chapter 6, "LAN Interface").

5.4.4.2 Return to Manual Operation

Return to manual operation can be made manually via the front panel or remotely via the RSIB interface.

Manually:

Press *LOCAL* softkey or *PRESET* key.



Make sure that the execution of commands is completed prior to switch over since otherwise the instrument will switch back to remote control immediately.

Via RSIB interface:

```
CALL RSDLLibloc(analyzer%, ibsta%, iberr%, ibcntl&)  
'Set device to manual operation
```

5.5 Messages

The messages transferred via the data lines of the GPIB (see chapter [“Maintenance and Instrument Interfaces”](#), section [“GPIB Interface”](#) on page 8.2) can be divided into two groups:

- [“GPIB Interface Messages”](#)
- [“Device Messages \(Commands and Device Responses\)”](#)

5.5.1 GPIB Interface Messages

Interface messages are transferred on the data lines of the GPIB, the "ATN" control line being active. They are used for communication between controller and instrument and can only be sent by a controller which has the remote control. Interface commands can be subdivided into

- **universal commands** and
- **addressed commands**.

Universal commands act on all devices connected to the GPIB without previous addressing, addressed commands only act on devices previously addressed as listeners. The interface messages relevant to the instrument are listed in chapter [“Maintenance and Instrument Interfaces”](#), section [“Interface Functions”](#) on page 8.4.

5.5.2 Device Messages (Commands and Device Responses)

Device messages are transferred on the data lines of the GPIB, the "ATN" control line not being active. ASCII code is used.

A distinction is made according to the direction in which they are sent on the GPIB:

- **Commands** are messages the controller sends to the instrument. They operate the device functions and request informations.

The commands are subdivided according to two criteria:

- According to the effect they have on the instrument:

Setting commands cause instrument settings such as reset of the instrument or setting the center frequency.

Queries cause data to be provided for output on the GPIB, e.g. for identification of the device or polling the marker.

- According to their definition in standard IEEE 488.2:

Common Commands are exactly defined as to their function and notation in standard IEEE 488.2. They refer to functions such as management of the standardized status registers, reset and selftest.

Device-specific commands refer to functions depending on the features of the instrument such as frequency setting. A majority of these commands has also been standardized by the SCPI committee (cf. section [“SCPI Introduction”](#) on page 5.9).

- **Device responses** are messages the instrument sends to the controller after a query. They can contain measurement results, instrument settings and information on the instrument status (cf. section [“Responses to Queries”](#) on page 5.12).

Structure and syntax of the device messages are described in the following section.

5.6 Structure and Syntax of the Device Messages

5.6.1 SCPI Introduction

SCPI (Standard Commands for Programmable Instruments) describes a standard command set for programming instruments, irrespective of the type of instrument or manufacturer. The goal of the SCPI consortium is to standardize the device-specific commands to a large extent. For this purpose, a model was developed which defines the same functions inside a device or for different devices. Command systems were generated which are assigned to these functions. Thus it is possible to address the same functions with identical commands. The command systems are of a hierarchical structure.

Fig. 5.1 illustrates this tree structure using a section of command system SENSE, which controls the device-specific settings, that do not refer to the signal characteristics of the measurement signal. Further examples of structure and syntax are taken from this command system.

SCPI is based on standard IEEE 488.2, i.e. it uses the same syntactic basic elements as well as the common commands defined in this standard. Part of the syntax of the device responses is defined with greater restrictions than in standard IEEE 488.2 (see section [“Responses to Queries”](#) on page 5.12).

5.6.2 Structure of a Command

The commands consist of a so-called header and, in most cases, one or more parameters. Header and parameter are separated by a "white space" (ASCII code 0 to 9, 11 to 32 decimal, e.g. blank). The headers may consist of several key words. Queries are formed by directly appending a question mark to the header.



The commands used in the following examples are not in every case implemented in the instrument.

Common commands

Common commands consist of a header preceded by an asterisk "*" and one or several parameters, if any.

Examples:

*RST

RESET, resets the device

*ESE 253

EVENT STATUS ENABLE, sets the bits of the event status enable register

*ESR?

EVENT STATUS QUERY, queries the contents of the event status register.

Device-specific commands

Hierarchy:

Device-specific commands are of hierarchical structure (see Fig. 5.1). The different levels are represented by combined headers. Headers of the highest level (root level) have only one key word. This key word denotes a complete command system.

Example:

```
SENSe
```

This key word denotes the command system `SENSe`.

For commands of lower levels, the complete path has to be specified, starting on the left with the highest level, the individual key words being separated by a colon ":".

Example:

```
SENSe:FREQuency:SPAN 10MHZ
```

This command lies in the third level of the `SENSe` system. It sets the frequency span.

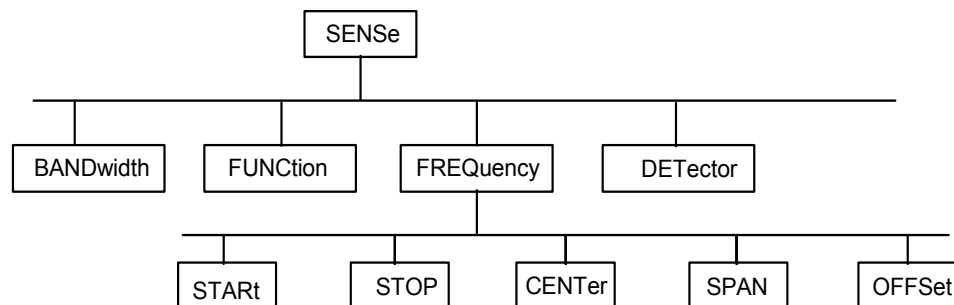

Fig. 5.1 Tree structure the SCPI command systems using the `SENSe` system by way of example

Some key words occur in several levels within one command system. Their effect depends on the structure of the command, that is to say, at which position in the header of a command they are inserted.

Examples:

```
SOURce:FM:POLarity NORMal
```

This command contains key word `POLarity` in the third command level. It defines the polarity between modulator and modulation signal.

```
SOURce:FM:EXTernal:POLarity NORMal
```

This command contains key word `POLarity` in the fourth command level. It defines the polarity between modulation voltage and the resulting direction of the modulation only for the external signal source indicated.

Optional key words

Some command systems permit certain key words to be optionally inserted into the header or omitted. These key words are marked by square brackets in the description. The full command length must be recognized by the instrument for reasons of compatibility with the SCPI standard. Some commands are considerably shortened by these optional key words.

Example:

```
[SENSe]:BANDwidth[:RESolution]:AUTO
```

This command couples the resolution bandwidth of the instrument to other parameters. The following command has the same effect:

```
BANDwidth:AUTO
```



An optional key word must not be omitted if its effect is specified in detail by a numeric suffix.

Long and short form

The key words feature a long form and a short form. Either the short form or the long form can be entered, other abbreviations are not permissible.

Example:

```
STATus:QUEStionable:ENABle 1= STAT:QUES:ENAB 1
```



The short form is marked by upper-case letters, the long form corresponds to the complete word. Upper-case and lower-case notation only serve the above purpose, the instrument itself does not make any difference between upper-case and lower-case letters.

Parameter

The parameter must be separated from the header by a "white space". If several parameters are specified in a command, they are separated by a comma ",". A few queries permit the parameters MINimum, MAXimum and DEFault to be entered. For a description of the types of parameter, refer to section "[Parameters](#)" on page 5.13.

Example:

```
SENSe:FREQuency:STOP? MAXimum
```

This query requests the maximal value for the stop frequency. Response: 3.5E9

Numeric suffix

If a device features several functions or features of the same kind, e.g. inputs, the desired function can be selected by a suffix added to the command. Entries without suffix are interpreted like entries with the suffix 1.

Example:

```
SYSTem:COMMunicate:SERial2:BAUD 9600
```

This command sets the baudrate of a second serial interface.

5.6.3 Structure of a Command Line

A command line may consist of one or several commands. It is terminated by a <New Line>, a <New Line> with EOI or an EOI together with the last data byte. The IEC/IEEE driver of the controller usually produces automatically an EOI together with the last data byte.

Several commands in a command line are separated by a semicolon ";". If the next command belongs to a different command system, the semicolon is followed by a colon.

Example:

```
CALL IBWRT(analyzer%, "SENSe:FREQuency:CENTer 100MHz;:INPut:
ATTenuation 10")
```

This command line contains two commands. The first one is part of the SENSE command system and is used to determine the center frequency of the instrument. The second one is part of the INPUT command system and sets the input signal attenuation.

If the successive commands belong to the same system, having one or several levels in common, the command line can be abbreviated. For that purpose, the second command after the semicolon starts with the level that lies below the common levels (see also Fig. 5.1). The colon following the semicolon must be omitted in this case.

Example:

```
CALL IBWRT(analyzer%, "SENSe:FREQuency:START 1E6;:SENSe:
FREQuency:STOP 1E9")
```

This command line is represented in its full length and contains two commands separated from each other by the semicolon. Both commands are part of the SENSE command system, subsystem FREQUENCY, i.e. they have two common levels.

When abbreviating the command line, the second command begins with the level below SENSE:FREQUENCY. The colon after the semicolon is omitted.

The abbreviated form of the command line reads as follows:

```
CALL IBWRT(analyzer%, "SENSe:FREQuency:START 1E6;STOP 1E9")
```

However, a new command line always begins with the complete path.

Example:

```
CALL IBWRT(analyzer, "SENSe:FREQuency:START 1E6")
CALL IBWRT(analyzer%, "SENSe:FREQuency:STOP 1E9")
```

5.6.4 Responses to Queries

A query is defined for each setting command unless explicitly specified otherwise. It is formed by adding a question mark to the associated setting command. According to SCPI, the responses to queries are partly subject to stricter rules than in standard IEEE 488.2.

1. The requested parameter is transmitted without header.

Example: INPUT:COUPLing?

Response: DC

2. Maximum values, minimum values and all further quantities, which are requested via a special text parameter are returned as numerical values.

Example: SENSE:FREQuency:STOP? MAX

Response: 3.5E9

3. Numerical values are output without a unit. Physical quantities are referred to the base units or to the units set using the Unit command.

Example: `SENSe:FREQuency:CENTer?`

Response: `1E6` for 1 MHz

4. Truth values <Boolean values> are returned as 0 (for OFF) and 1 (for ON).

Example: `SENSe:BANDwidth:AUTO?`

Response: `1` for ON

5. Text (character data) is returned in a short form.

Example: `SYSTem:COMMunicate:SERial:CONTRol:RTS?`

Response (for standard): `STAN`

5.6.5 Parameters

Most commands require a parameter to be specified. The parameters must be separated from the header by a "white space". Permissible parameters are numerical values, Boolean parameters, text, character strings and block data. The type of parameter required for the respective command and the permissible range of values are specified in the command description

Numerical values

Numerical values can be entered in any form, i.e. with sign, decimal point and exponent. Values exceeding the resolution of the instrument are rounded up or down. The mantissa may comprise up to 255 characters, the exponent must lie inside the value range -32000 to 32000. The exponent is introduced by an "E" or "e". Entry of the exponent alone is not permissible. In the case of physical quantities, the unit can be entered. Permissible unit prefixes are G (giga), MA (mega), MOHM and MHZ are also permissible), K (kilo), M (milli), U (micro) and N (nano). If the unit is missing, the base unit is used.

Example:

`SENSe:FREQuency:STOP 1.5GHz = SENSe:FREQuency:STOP 1.5E9`

Special numerical

The texts MINimum, MAXimum, DEFault, UP and DOWN are interpreted as values special numerical values.

In the case of a query, the numerical value is provided.

Example:

Setting command: `SENSe:FREQuency:STOP MAXimum`

Query: `SENSe:FREQuency:STOP?`

Response: `3.5E9`

MIN/MAX

MINimum and MAXimum denote the minimum and maximum value.

DEF

DEFault denotes a preset value which has been stored in the EPROM. This value conforms to the default setting, as it is called by the *RST command

UP/DOWN

UP, DOWN increases or reduces the numerical value by one step. The step width can be specified via an allocated step command (see annex C, List of Commands) for each parameter which can be set via UP, DOWN.

INF/NINF

INFinity, Negative INFinity (NINF) Negative INFinity (NINF) represent the numerical values $-9.9E37$ or $9.9E37$, respectively. INF and NINF are only sent as device responses.

NAN

Not A Number (NAN) represents the value $9.91E37$. NAN is only sent as device response. This value is not defined. Possible causes are the division of zero by zero, the subtraction of infinite from infinite and the representation of missing values.

Boolean Parameters

Boolean parameters represent two states. The ON state (logically true) is represented by ON or a numerical value unequal to 0. The OFF state (logically untrue) is represented by OFF or the numerical value 0. 0 or 1 is provided in a query.

Example:

Setting command: `DISPlay:WINDow:STATe ON`

Query: `DISPlay:WINDow:STATe?`

Response: 1

Text

Text parameters observe the syntactic rules for key words, i.e. they can be entered using a short or long form. Like any parameter, they have to be separated from the header by a white space. In the case of a query, the short form of the text is provided.

Example:

Setting command: `INPut:COUPling GROund`

Query: `INPut:COUPling?`

Response: GRO

Strings

Strings must always be entered in quotation marks (' or ").

Example:

`SYSTem:LANGuage "SCPI" or`

`SYSTem:LANGuage 'SCPI'`

Block data

Block data is a transmission format which is suitable for the transmission of large amounts of data. A command using a block data parameter has the following structure.

Example:

```
HEADer:HEADer #45168xxxxxxxx
```

ASCII character # introduces the data block. The next number indicates how many of the following digits describe the length of the data block. In the example, the 4 following digits indicate the length to be 5168 bytes. The data bytes follow. During the transmission of these data bytes, all End or other control signs are ignored until all bytes are transmitted.

This format only supports a byte count up to 9 digits for the number of bytes. For more than 999999999 bytes, following additional format is used.

Example:

```
HEADer:HEADer #(1100000000) xxxxxxxx
```

The byte length count if put into brackets. In the example, the byte counts indicates a length of 1.100.000.000 bytes. The data bytes follow the close bracket.

5.6.6 Overview of Syntax Elements

The following survey offers an overview of the syntax elements.

- : The colon separates the key words of a command.
In a command line the colon after the separating semicolon marks the uppermost command level.
- ; The semicolon separates two commands of a command line. It does not alter the path.
- ,
- ? The question mark forms a query.
- * The asterisk marks a common command.
- " Quotation marks introduce a string and terminate it.
- # The double dagger introduces block data.
A white space (ASCII code 0 to 9, 11 to 32 decimal, e.g. blank) separates header and parameter.

5.6.7 Instrument Model and Command Processing

The instrument model shown in [Fig. 5.2](#) has been made viewed from the standpoint of the servicing of remote commands. The individual components work independently of each other and simultaneously. They communicate by means of so-called "messages".

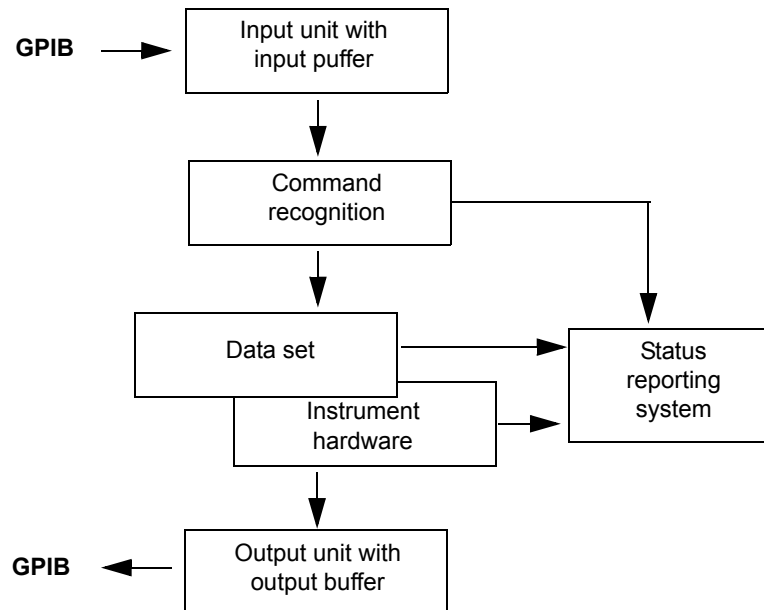

Fig. 5.2 Instrument model in the case of remote control by means of the GPIB

5.6.8 Input Unit

The input unit receives commands character by character from the GPIB and collects them in the input buffer. The input unit sends a message to the command recognition as soon as the input buffer is full or as soon as it receives a delimiter, <PROGRAM MESSAGE TERMINATOR>, as defined in IEEE 488.2, or the interface message DCL.

If the input buffer is full, the GPIB traffic is stopped and the data received up to then are processed. Subsequently the GPIB traffic is continued. If, however, the buffer is not yet full when receiving the delimiter, the input unit can already receive the next command during command recognition and execution. The receipt of a DCL clears the input buffer and immediately initiates a message to the command recognition.

5.6.9 Command Recognition

The command recognition analyses the data received from the input unit. It proceeds in the order in which it receives the data. Only a DCL is serviced with priority, a GET (Group Execute Trigger), e.g., is only executed after the commands received before as well. Each recognized command is immediately transferred to the instrument data base but without being executed there at once.

Syntactical errors in the command are recognized in the command recognition and supplied to the status reporting system. The rest of a command line after a syntax error is analyzed further if possible and serviced.

If the command recognition recognizes a delimiter (<PROGRAM MESSAGE SEPARATOR> or <PROGRAM MESSAGE TERMINATOR>) or a DCL, it requests the instrument data base to set the commands in the instrument hardware as well now. Subsequently it is immediately prepared to process commands again. This means for the command servicing that further commands can already be serviced while the hardware is still being set ("overlapping execution").

5.6.10 Instrument Data Base and Instrument Hardware

Here the expression "instrument hardware" denotes the part of the instrument fulfilling the actual instrument function - signal generation, measurement etc. The controller is not included.

The instrument data base is a detailed reproduction of the instrument hardware in the software.

GPIB setting commands lead to an alteration in the data set. The data base management enters the new values (e.g. frequency) into the data base, however, only passes them on to the hardware when requested by the command recognition.

The data are only checked for their compatibility among each other and with the instrument hardware immediately before they are transmitted to the instrument hardware. If the detection is made that an execution is not possible, an "execution error" is signalled to the status reporting system. The alteration of the data base are cancelled, the instrument hardware is not reset.

GPIB queries induce the data base management to send the desired data to the output unit.

5.6.11 Status Reporting System

The status reporting system collects information on the instrument state and makes it available to the output unit on request. The exact structure and function are described in section "[Overview of the Status Registers](#)" on page 5.21.

5.6.12 Output Unit

The output unit collects the information requested by the controller, which it receives from the data base management. It processes it according to the SCPI rules and makes it available in the output buffer. If the instrument is addressed as a talker without the output buffer containing data or awaiting data from the data base management, the output unit sends error message "Query UNTERMINATED" to the status reporting system. No data are sent on the GPIB, the controller waits until it has reached its time limit. This behavior is specified by SCPI.

5.6.13 Command Sequence and Command Synchronization

What has been said above makes clear that all commands can potentially be carried out overlapping.

In order to prevent an overlapping execution of commands, one of commands *OPC, *OPC? or *WAI must be used. All three commands cause a certain action only to be carried out after the hardware has been set and has settled. By a suitable programming, the controller can be forced to wait for the respective action to occur.

Command	Action after the hardware has settled	Programming the controller
*OPC	Setting the operation-complete bit in the ESR	- Setting bit 0 in the ESE - Setting bit 5 in the SRE - Waiting for service request (SRQ)
*OPC?	Writing a "1" into the output buffer	Addressing the instrument as a talker
*WAI	Continuing the GPIB handshake	Sending the next command

An example as to command synchronization can be found in chapter “[Remote Control – Programming Examples](#)”.

For a couple of commands the synchronization to the end of command execution is mandatory in order to obtain the desired result. The affected commands require either more than one measurement in order to accomplish the desired instrument setting (e.g. auto range functions), or they require a longer period of time for execution. If a new command is received during execution of the corresponding function this may either lead to either to an aborted measurement or to invalid measurement data.

The following list includes the commands, for which a synchronization via *OPC, *OPC? or *WAI is mandatory:

Command	Purpose
INIT	start measurement
INIT:CONM	continue measurement
CALC:MARK:FUNC:ZOOM	zoom frequency range around marker 1
CALC:STAT:SCAL:AUTO ONCE	optimize level settings for signal statistic measurement functions
[SENS:]POW:ACH:PRES:RLEV	optimize level settings for adjacent channel power measurements

5.7 Status Reporting System

The status reporting system (cf. [Fig. 5.4](#)) stores all information on the present operating state of the instrument, e.g. that the instrument presently carries out a calibration and on errors which have occurred. This information is stored in the status registers and in the error queue. The status registers and the error queue can be queried via GPIB.

The information is of a hierarchical structure. The register status byte (STB) defined in IEEE 488.2 and its associated mask register service request enable (SRE) form the uppermost level. The STB receives its information from the standard event status register (ESR) which is also defined in IEEE 488.2 with the associated mask register standard event status enable (ESE) and registers STATUS:OPERation and STATUS:QUEStionable which are defined by SCPI and contain detailed information on the instrument.

The IST flag ("Individual SStatus") and the parallel poll enable register (PPE) allocated to it are also part of the status reporting system. The IST flag, like the SRQ, combines the entire instrument status in a single bit. The PPE fulfills the same function for the IST flag as the SRE for the service request.

The output buffer contains the messages the instrument returns to the controller. It is not part of the status reporting system but determines the value of the MAV bit in the STB and thus is represented in [Fig. 5.4](#).

5.7.1 Structure of an SCPI Status Register

Each SCPI register consists of 5 parts which each have a width of 16 bits and have different functions (cf. [Fig. 5.3](#)). The individual bits are independent of each other, i.e. each hardware status is assigned a bit number which is valid for all five parts. For example, bit 3 of the STATUS:OPERation register is assigned to the hardware

status "wait for trigger" in all five parts. Bit 15 (the most significant bit) is set to zero for all parts. Thus the contents of the register parts can be processed by the controller as positive integer.

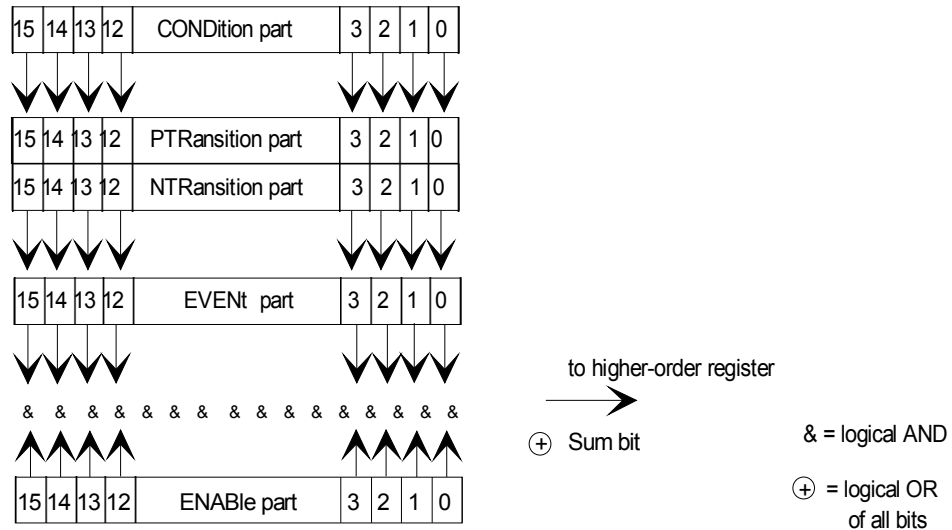

Fig. 5.3 The status-register model

CONDition part

The CONDition part is directly written into by the hardware or the sum bit of the next lower register. Its contents reflects the current instrument status. This register part can only be read, but not written into or cleared. Its contents is not affected by reading.

PTRansition part

The Positive-TRansition part acts as an edge detector. When a bit of the CONDition part is changed from 0 to 1, the associated PTR bit decides whether the EVENT bit is set to 1.

PTR bit =1: the EVENT bit is set.

PTR bit =0: the EVENT bit is not set.

This part can be written into and read at will. Its contents is not affected by reading.

NTRansition part

The Negative-TRansition part also acts as an edge detector. When a bit of the CONDition part is changed from 1 to 0, the associated NTR bit decides whether the EVENT bit is set to 1.

NTR-Bit = 1: the EVENT bit is set.

NTR-Bit = 0: the EVENT bit is not set.

This part can be written into and read at will. Its contents is not affected by reading.

With these two edge register parts the user can define which state transition of the condition part (none, 0 to 1, 1 to 0 or both) is stored in the EVENT part.

EVENT part

The EVENT part indicates whether an event has occurred since the last reading, it is the "memory" of the condition part. It only indicates events passed on by the edge filters. It is permanently updated by the instrument. This part can only be read by the user. During reading, its contents is set to zero. In linguistic usage this part is often equated with the entire register.

ENABLE part

The ENABLE part determines whether the associated EVENT bit contributes to the sum bit (cf. below). Each bit of the EVENT part is ANDed with the associated ENABLE bit (symbol '&'). The results of all logical operations of this part are passed on to the sum bit via an OR function (symbol '+').

ENABLE-Bit = 0: the associated EVENT bit does not contribute to the sum bit

ENABLE-Bit = 1: if the associated EVENT bit is "1", the sum bit is set to "1" as well.

This part can be written into and read by the user at will. Its contents is not affected by reading.

Sum bit

As indicated above, the sum bit is obtained from the EVENT and ENABLE part for each register. The result is then entered into a bit of the CONDition part of the higher-order register.

The instrument automatically generates the sum bit for each register. Thus an event, e.g. a PLL that has not locked, can lead to a service request throughout all levels of the hierarchy.



The service request enable register SRE defined in IEEE 488.2 can be taken as ENABLE part of the STB if the STB is structured according to SCPI. By analogy, the ESE can be taken as the ENABLE part of the ESR.

5.7.2 Overview of the Status Registers

The following figure shows the status registers used by the R&S ESCI base unit. The status registers used by the R&S ESCI options are described in the separate software manuals.

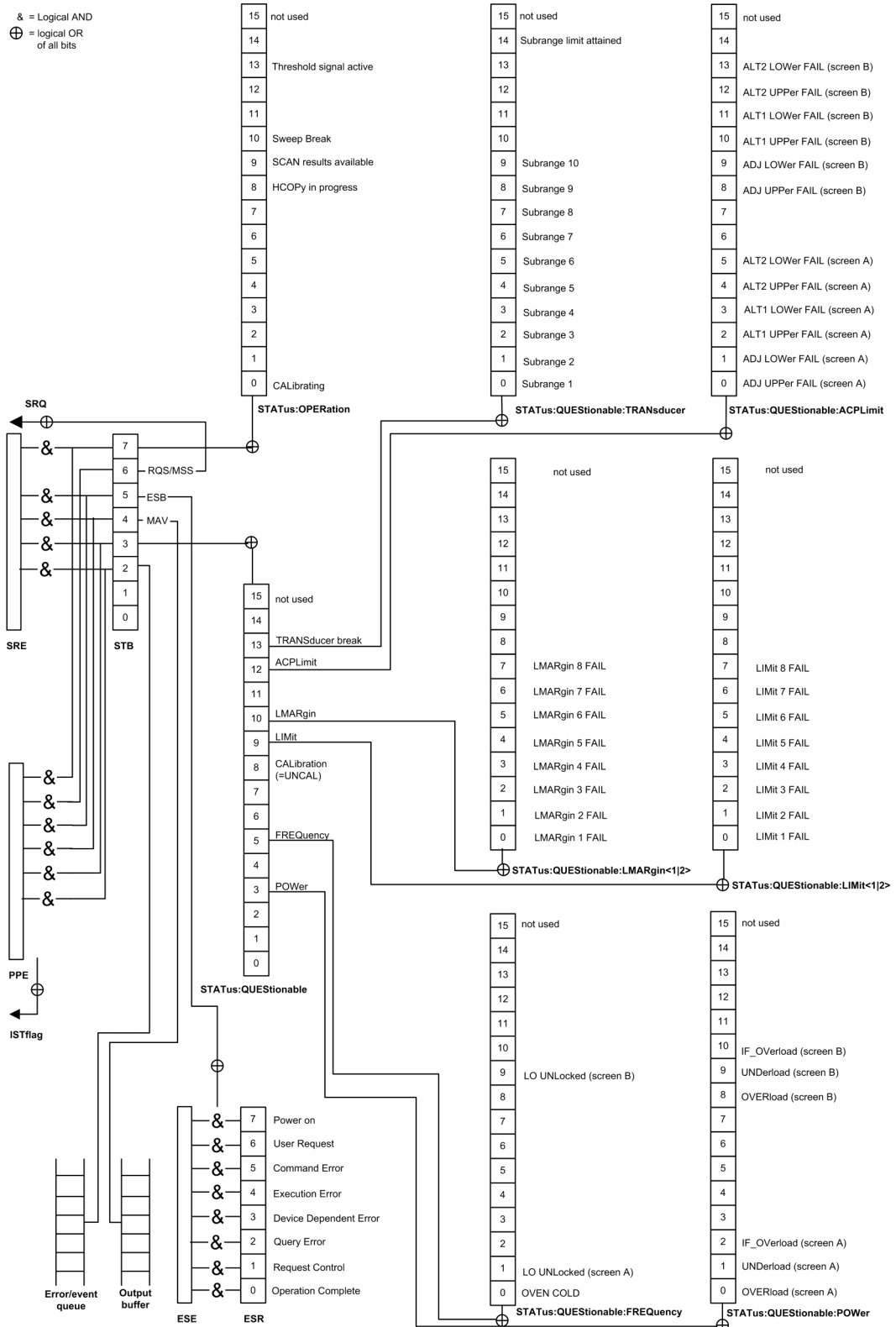

Fig. 5.4 Overview of the status registers (base unit)

5.7.3 Description of the Status Registers

5.7.3.1 Status Byte (STB) and Service Request Enable Register (SRE)

The STB is already defined in IEEE 488.2. It provides a rough overview of the instrument status by collecting the pieces of information of the lower registers. It can thus be compared with the CONDition part of an SCPI register and assumes the highest level within the SCPI hierarchy. A special feature is that bit 6 acts as the sum bit of the remaining bits of the status byte.

The STATUS BYTE is read out using the command "***STB?**" or a serial poll.

The STB implies the SRE. It corresponds to the ENABLE part of the SCPI registers as to its function. Each bit of the STB is assigned a bit in the SRE. Bit 6 of the SRE is ignored. If a bit is set in the SRE and the associated bit in the STB changes from 0 to 1, a Service Request (SRQ) is generated on the GPIB, which triggers an interrupt in the controller if this is appropriately configured and can be further processed there.

The SRE can be set using command "***SRE**" and read using "***SRE?**".

Bit No.	Meaning
2	<p>Error Queue not empty</p> <p>The bit is set when an entry is made in the error queue.</p> <p>If this bit is enabled by the SRE, each entry of the error queue generates a Service Request. Thus an error can be recognized and specified in greater detail by polling the error queue. The poll provides an informative error message. This procedure is to be recommended since it considerably reduces the problems involved with GPIB control.</p>
3	<p>QUESTIONable status sum bit</p> <p>The bit is set if an EVENT bit is set in the QUESTIONable: status register and the associated ENABLE bit is set to 1.</p> <p>A set bit indicates a questionable instrument status, which can be specified in greater detail by polling the QUESTIONable status register.</p>
4	<p>MAV bit (message available)</p> <p>The bit is set if a message is available in the output buffer which can be read.</p> <p>This bit can be used to enable data to be automatically read from the instrument to the controller (cf. chapter "Remote Control – Programming Examples").</p>
5	<p>ESB bit</p> <p>Sum bit of the event status register. It is set if one of the bits in the event status register is set and enabled in the event status enable register.</p> <p>Setting of this bit implies an error or an event which can be specified in greater detail by polling the event status register.</p>
6	<p>MSS bit (master status summary bit)</p> <p>The bit is set if the instrument triggers a service request. This is the case if one of the other bits of this registers is set together with its mask bit in the service request enable register SRE.</p>
7	<p>OPERation status register sum bit</p> <p>The bit is set if an EVENT bit is set in the OPERation-Status register and the associated ENABLE bit is set to 1.</p> <p>A set bit indicates that the instrument is just performing an action. The type of action can be determined by polling the OPERation-status register.</p>

5.7.3.2 IST Flag and Parallel Poll Enable Register (PPE)

By analogy with the SRQ, the IST flag combines the entire status information in a single bit. It can be queried by means of a parallel poll (cf. section “Parallel Poll” on page 5.30) or using command “*IST?”.

The parallel poll enable register (PPE) determines which bits of the STB contribute to the IST flag. The bits of the STB are ANDed with the corresponding bits of the PPE, with bit 6 being used as well in contrast to the SRE. The Ist flag results from the ORing of all results. The PPE can be set using commands “*PRE” and read using command “*PRE?”.

5.7.3.3 Event-Status Register (ESR) and Event-Status-Enable Register (ESE)

The ESR is already defined in IEEE 488.2. It can be compared with the EVENT part of an SCPI register. The event status register can be read out using command “*ESR?”.

The ESE is the associated ENABLE part. It can be set using command “*ESE” and read using command “*ESE?”.

Bit No.	Meaning
0	Operation Complete This bit is set on receipt of the command *OPC exactly when all previous commands have been executed.
1	This bit is not used
2	Query Error This bit is set if either the controller wants to read data from the instrument without having send a query, or if it does not fetch requested data and sends new instructions to the instrument instead. The cause is often a query which is faulty and hence cannot be executed.
3	Device-dependent Error This bit is set if a device-dependent error occurs. An error message with a number between -300 and -399 or a positive error number, which denotes the error in greater detail, is entered into the error queue (cf. chapter “Error Messages”).
4	Execution Error This bit is set if a received command is syntactically correct, however, cannot be performed for other reasons. An error message with a number between -200 and -300, which denotes the error in greater detail, is entered into the error queue (cf. chapter “Error Messages”).
5	Command Error This bit is set if a command which is undefined or syntactically incorrect is received. An error message with a number between -100 and -200, which denotes the error in greater detail, is entered into the error queue (cf. chapter “Error Messages”).
6	User Request This bit is set on pressing the LOCAL key.
7	Power On (supply voltage on) This bit is set on switching on the instrument.

5.7.3.4 STATus:OPERation Register

In the CONDition part, this register contains information on which actions the instrument is being executing or, in the EVENT part, information on which actions the instrument has executed since the last reading. It can be read using commands "STATus:OPERation:CONDition?" or "STATus:OPERation[:EVENT]?".

Bit No.	Meaning
0	CALibrating This bit is set as long as the instrument is performing a calibration.
1 to 7	These bits are not used
8	HardCOPy in progress This bit is set while the instrument is printing a hardcopy.
9	SCAN results available This bit is set when a block of scan results is available. Must be enabled by TRAC:FEED:CONT ALWays
10	Sweep Break This bit is set when end of sweep range is reached (spurious measurement, mode analyzer). Command "INIT:CONM" has to be used to proceed.
11 to 12	These bits are not used
13	Threshold signal active
14	This bit is not used
15	This bit is always 0

5.7.3.5 STATus:QUEStionable Register

This register comprises information about indefinite states which may occur if the unit is operated without meeting the specifications. It can be queried by commands `STATus:QUEStionable:CONDition?` and `STATus:QUEStionable[:EVENT]?`.

Bit No.	Meaning
0 to 2	These bits are not used.
3	POWER This bit is set if a questionable power occurs (cf. also section " STATus:QUEStionable:POWER Register " on page 5.28)
4	This bit is not used.
5	FREQUENCY The bit is set if a frequency is questionable (cf. section " STATus:QUEStionable:FREQUENCY Register " on page 5.27)
6	This bit is not used.
7	This bit is not used
8	CALibration The bit is set if a measurement is performed uncalibrated (equivalent to label "UNCAL")
9	LIMit (device-specific) This bit is set if a limit value is violated (see also section " STATus:QUEStionable:LIMit<1 2> Register " on page 5.27)
10	LMARgin This bit is set if a margin is violated (see also section " STATus:QUEStionable:LMARgin<1 2> Register " on page 5.28)
11	This bit is not used
12	ACPLimit This bit is set if a limit for the adjacent channel power measurement is violated (see also section " STATus:QUEStionable:ACPLimit Register " on page 5.26)
13	TRANSDucer break
14	This bit is not used
15	This bit is always 0.

5.7.3.6 STATUS:QUESTIONABLE:ACPLimit Register

This register comprises information about the observance of limits during adjacent power measurements. It can be queried with commands `STATUS:QUESTIONABLE:ACPLimit:CONDITION?` and `STATUS:QUESTIONABLE:ACPLimit[:EVENT]?`.

Bit No.	Meaning
0	ADJ UPPER FAIL (Screen A) This bit is set if in screen A. the limit is exceeded in the upper adjacent channel
1	ADJ LOWER FAIL (Screen A) This bit is set if in screen A the limit is exceeded in the lower adjacent channel.
2	ALT1 UPPER FAIL (Screen A) This bit is set if in screen A the limit is exceeded in the upper 1st alternate channel.
3	ALT1 LOWER FAIL (Screen A) This bit is set if in screen A the limit is exceeded in the lower 1st alternate channel.
4	ALT2 UPPER FAIL (Screen A) This bit is set if in screen A the limit is exceeded in the upper 2nd alternate channel.
5	ALT2 LOWER FAIL (Screen A) This bit is set if in screen A the limit is exceeded in the lower 2nd alternate channel.
6	ALT3 to 11 LOWER/UPPER FAIL (Screen A) This bit is set if in screen A the limit is exceeded in one of the lower or upper alternate channels 3 to 11.
7	not used
8	ADJ UPPER FAIL (Screen B) This bit is set if in screen B the limit is exceeded in the upper adjacent channel.
9	ADJ LOWER FAIL (Screen B) This bit is set if in screen B the limit is exceeded in the lower adjacent channel.
10	ALT1 UPPER FAIL (Screen B) This bit is set if in screen B the limit is exceeded in the upper 1st alternate channel.
11	ALT1 LOWER FAIL (Screen B) This bit is set if in screen B the limit is exceeded in the lower 1st alternate channel.
12	ALT2 UPPER FAIL (Screen B) This bit is set if in screen B the limit is exceeded in the upper 2nd alternate channel.
13	ALT2 LOWER FAIL (Screen B) This bit is set if in screen B the limit is exceeded in the lower 2nd alternate channel.
14	This bit is not used.
15	This bit is always set to 0.

5.7.3.7 STATUS:QUESTIONABLE:FREQUENCY Register

This register comprises information about the reference and local oscillator.

It can be queried with commands `STATUS:QUESTIONABLE:FREQUENCY:CONDITION?` and `STATUS:QUESTIONABLE:FREQUENCY[:EVENT]?`.

Bit No.	Meaning
0	OVEN COLD This bit is set if the reference oscillator has not yet attained its operating temperature. 'OCXO' will then be displayed.
1	LO UNLocked (Screen A) This bit is set if the local oscillator no longer locks. 'LOUNL' will then be displayed.
2 to 8	not used
9	LO UNLocked (Screen B) This bit is set if the local oscillator no longer locks. 'LOUNL' will then be displayed.
10 to 14	not used
15	This bit is always 0.

5.7.3.8 STATUS:QUESTIONABLE:LIMIT<1|2> Register

This register comprises information about the observance of limit lines in the corresponding measurement window (LIMIT 1 corresponds to Screen A, LIMIT 2 to Screen B). It can be queried with commands `STATUS:QUESTIONABLE:LIMIT<1|2>:CONDITION?` and `STATUS:QUESTIONABLE:LIMIT<1|2>[:EVENT]?`.

Bit No.	Meaning
0	LIMIT 1 FAIL This bit is set if limit line 1 is violated.
1	LIMIT 2 FAIL This bit is set if limit line 2 is violated.
2	LIMIT 3 FAIL This bit is set if limit line 3 is violated.
3	LIMIT 4 FAIL This bit is set if limit line 4 is violated.
4	LIMIT 5 FAIL This bit is set if limit line 5 is violated.
5	LIMIT 6 FAIL This bit is set if limit line 6 is violated.
6	LIMIT 7 FAIL This bit is set if limit line 7 is violated.
7	LIMIT 8 FAIL This bit is set if limit line 8 is violated.
8 to 14	not used
15	This bit is always 0.

5.7.3.9 STATUS:QUESTIONABLE:LMARGIN<1|2> Register

This register comprises information about the observance of limit margins in the corresponding measurement window (LMARGIN1 corresponds to Screen A, LMARGIN2 corresponds to Screen B). It can be queried with commands `STATUS:QUESTIONABLE:LMARGIN<1|2>:CONDITION?` and `"STATUS:QUESTIONABLE:LMARGIN<1|2>[:EVENT]?"`.

Bit No.	Meaning
0	LMARGIN 1 FAIL This bit is set if limit margin 1 is violated.
1	LMARGIN 2 FAIL This bit is set if limit margin 2 is violated.
2	LMARGIN 3 FAIL This bit is set if limit margin 3 is violated.
3	LMARGIN 4 FAIL This bit is set if limit margin 4 is violated.
4	LMARGIN 5 FAIL This bit is set if limit margin 5 is violated.
5	LMARGIN 6 FAIL This bit is set if limit margin 1 is violated.
6	LMARGIN 7 FAIL This bit is set if limit margin 7 is violated.
7	LMARGIN 8 FAIL This bit is set if limit margin 8 is violated.
8 to 14	not used
15	This bit is always 0.

5.7.3.10 STATUS:QUESTIONABLE:POWER Register

This register comprises all information about possible overloads of the unit.

It can be queried with commands `STATUS:QUESTIONABLE:POWER:CONDITION?` and `STATUS:QUESTIONABLE:POWER[:EVENT]?"`.

Bit No.	Meaning
0	OVERload (Screen A) This bit is set if the RF input is overloaded. 'OVLD' will then be displayed.
1	UNDerload (Screen A) This bit is set if the RF input is underloaded. 'UNLD' will then be displayed.
2	IF_OVERload (Screen A) This bit is set if the IF path is overloaded. 'IFOVL' will then be displayed.
3 to 7	not used
8	OVERload (Screen B) This bit is set if the RF input is overloaded. 'OVLD' will then be displayed.

Bit No.	Meaning
9	UNDerload (Screen B) This bit is set if the RF input is underloaded. 'UNLD' will then be displayed.
10	IF_Overload (Screen B) This bit is set if the IF path is overloaded. 'IFOVL' will then be displayed.
11 to 14	not used
15	This bit is always 0.

5.7.3.11 STATus:QUEStionable:TRANsducer Register

This register indicates that a transducer hold point is attained (bit 15) and what range is to be swept next (bit 0 to 10). The sweep can be continued with command "INITiate<1|2>:CONMeas".

It can be queried with commands "STATus:QUEStionable:TRANsducer:CONDition?" and "STATus:QUEStionable:TRANsducer[:EVENTj]?".

Bit No.	Meaning
0	Range 1 This bit is set when subrange 1 is attained.
1	Range 2 This bit is set when subrange 1 is attained.
2	Range 3 This bit is set when subrange 1 is attained.
3	Range 4 This bit is set when subrange 1 is attained.
4	Range 5 This bit is set when subrange 1 is attained.
5	Range 6 This bit is set when subrange 1 is attained.
6	Range 7 This bit is set when subrange 1 is attained.
7	Range 8 This bit is set when subrange 1 is attained.
8	Range 9 This bit is set when subrange 1 is attained.
9	Range 10 This bit is set when subrange 1 is attained.
10 to 13	not used
14	Subrange limit This bit is set when the transducer is at the point of changeover from one range to another.
15	This bit is always 0.

5.7.4 Application of the Status Reporting Systems

In order to be able to effectively use the status reporting system, the information contained there must be transmitted to the controller and further processed there. There are several methods which are represented in the following. Detailed program examples are to be found in chapter [“Remote Control – Programming Examples”](#).

5.7.4.1 Service Request, Making Use of the Hierarchy Structure

Under certain circumstances, the instrument can send a service request (SRQ) to the controller. Usually this service request initiates an interrupt at the controller, to which the control program can react with corresponding actions. As evident from [Fig. 5.4](#), an SRQ is always initiated if one or several of bits 2, 3, 4, 5 or 7 of the status byte are set and enabled in the SRE. Each of these bits combines the information of a further register, the error queue or the output buffer. The corresponding setting of the ENABLE parts of the status registers can achieve that arbitrary bits in an arbitrary status register initiate an SRQ. In order to make use of the possibilities of the service request, all bits should be set to "1" in enable registers SRE and ESE.

Examples (cf. [Fig. 5.4](#) and chapter [“Remote Control – Programming Examples”](#)):

Use of command `"*OPC"` to generate an SRQ at the end of a sweep.

- `CALL IBWRT(analyzer%, "*ESE 1")` Set bit 0 in the ESE (Operation Complete)
- `CALL IBWRT(analyzer%, "*SRE 32")` Set bit 5 in the SRE (ESB)

After its settings have been completed, the instrument generates an SRQ.

The SRQ is the only possibility for the instrument to become active on its own. Each controller program should set the instrument in a way that a service request is initiated in the case of malfunction. The program should react appropriately to the service request. A detailed example for a service request routine is to be found in chapter [“Remote Control – Programming Examples”](#).

5.7.4.2 Serial Poll

In a serial poll, just as with command `"*STB"`, the status byte of an instrument is queried. However, the query is realized via interface messages and is thus clearly faster. The serial-poll method has already been defined in IEEE 488.1 and used to be the only standard possibility for different instruments to poll the status byte. The method also works with instruments which do not adhere to SCPI or IEEE 488.2.

The VISUAL BASIC command for executing a serial poll is `"IBRSP()"`. Serial poll is mainly used to obtain a fast overview of the state of several instruments connected to the GPIB.

5.7.4.3 Parallel Poll

In a parallel poll, up to eight instruments are simultaneously requested by the controller by means of a single command to transmit 1 bit of information each on the data lines, i.e., to set the data line allocated to each instrument to logically "0" or "1". By analogy to the SRE register which determines under which conditions an SRQ is generated, there is a parallel poll enable register (PPE) which is ANDed with the STB bit by bit as well considering bit 6. The results are ORed, the result is then sent (possibly inverted) as a response in the parallel poll of the controller. The result can also be queried without parallel poll by means of command `"*IST"`.

The instrument first has to be set for the parallel poll using quick-BASIC command "IBPPC()". This command allocates a data line to the instrument and determines whether the response is to be inverted. The parallel poll itself is executed using "IBRPP()".

The parallel-poll method is mainly used in order to quickly find out after an SRQ which instrument has sent the service request if there are many instruments connected to the GPIB. To this effect, SRE and PPE must be set to the same value. A detailed example as to the parallel poll is to be found in chapter "Remote Control – Programming Examples".

5.7.4.4 Query by Means of Commands

Each part of every status register can be read by means of queries. The individual commands are indicated in the detailed description of the registers. What is returned is always a number which represents the bit pattern of the register queried. Evaluating this number is effected by the controller program.

Queries are usually used after an SRQ in order to obtain more detailed information on the cause of the SRQ.

5.7.4.5 Error Queue Query

Each error state in the instrument leads to an entry in the error queue. The entries of the error queue are detailed plain-text error messages which can be looked at in the ERROR menu via manual operation or queried via the GPIB using `SYSTem:ERRor?` command. Each call of `SYSTem:ERRor?` provides an entry from the error queue. If no error messages are stored there any more, the instrument responds with 0, "No error".

The error queue should be queried after every SRQ in the controller program as the entries describe the cause of an error more precisely than the status registers. Especially in the test phase of a controller program the error queue should be queried regularly since faulty commands from the controller to the instrument are recorded there as well.

5.7.5 Resetting Values of the Status Reporting System

Table 5-13 comprises the different commands and events causing the status reporting system to be reset. None of the commands, except for *RST and `SYSTem:PRESet` influences the functional instrument settings. In particular, DCL does not change the instrument settings.

Event	Switching on supply voltage		DCL,SDC (Device Clear, Selected Device Clear)	*RST or SYSTem: PRESet	STATus: PRESet	*CLS
	Power-On-Status-Clear					
Effect	0	1				
Clear STB,ESR	—	yes	—	—	—	yes
Clear SRE,ESE	—	yes	—		—	—
Clear PPE	—	yes	—		—	—
Clear EVENTt parts of the registers	—	yes	—	—		yes

Event	Switching on supply voltage		DCL,SDC (Device Clear, Selected Device Clear)	*RST or SYSTem: PRESet	STATus: PRESet	*CLS
	Power-On-Status-Clear					
Effect	0	1				
Clear Enable parts of all OPERation and QUEStionable registers, Fill Enable parts of all other registers with "1".	—	yes	—	—	yes	—
Fill PTRansition parts with "1" , Clear NTRansition parts	—	yes	—	—	yes	—
Clear error queue	yes	yes	—	—	—	yes
Clear output buffer	yes	yes	yes	1)	1)	1)
Clear command processing and input buffer	yes	yes	yes	—	—	—

1) Every command being the first in a command line, i.e., immediately following a <PROGRAM MESSAGE TERMINATOR> clears the output buffer.

6 Remote Control – Description of Commands

6.1 Introduction	6.4
6.2 Notation	6.5
6.3 Common Commands	6.8
6.4 ABORt Subsystem	6.11
6.5 CALCulate Subsystem	6.12
6.5.1 CALCulate:DELTamarker Subsystem	6.13
6.5.2 CALCulate:ESPeCtRum Subsystem	6.21
6.5.3 CALCulate:LIMit Subsystem	6.22
6.5.3.1CALCulate:LIMit:ACPower Subsystem	6.27
6.5.3.2CALCulate:LIMit:CONTRol Subsystem	6.34
6.5.3.3CALCulate:LIMit:LOWer Subsystem	6.36
6.5.3.4CALCulate:LIMit:UPPer Subsystem	6.39
6.5.4 CALCulate:MARKer Subsystem	6.42
6.5.4.1CALCulate:MARKer:FUNcTION Subsystem	6.51
6.5.4.2CALCulate:MARKer:FUNcTION:HARMonics Subsystem	6.61
6.5.4.3CALCulate:MARKer:FUNcTION:POWer Subsystem	6.64
6.5.4.4CALCulate:MARKer:FUNcTION:STRack Subsystem	6.73
6.5.4.5CALCulate:MARKer:FUNcTION:SUMMary Subsystem	6.75
6.5.5 CALCulate:MATH Subsystem	6.87
6.5.6 CALCulate:PEAKsearch I PSEarch Subsystem	6.89
6.5.7 CALCulate:STATistics Subsystem	6.91
6.5.8 CALCulate:THReShold Subsystem	6.95
6.5.9 CALCulate:UNIT Subsystem	6.97
6.6 CALibration Subsystem	6.98
6.7 DIAGnostic Subsystem	6.100
6.8 DISPlay Subsystem	6.103
6.9 FORMat Subsystem	6.113
6.10 HCOPy Subsystem	6.114
6.11 INITiate Subsystem	6.120
6.12 INPut Subsystem	6.124
6.13 INSTRument Subsystem	6.128
6.14 MMEMory Subsystem	6.133
6.15 OUTPut Subsystem	6.146
6.16 SENSEe Subsystem	6.147
6.16.1 SENSEe:AVERAge Subsystem	6.148

6.16.2 SENSE:BANDwidth Subsystem	6.150
6.16.3 SENSE:CORRection Subsystem	6.154
6.16.4 SENSE:DEMod Subsystem	6.161
6.16.5 SENSE:DETeCtor Subsystem	6.162
6.16.6 SENSE:ESPeCtrum Subsystem	6.163
6.16.7 SENSE:FMEAsurement Subsystem	6.171
6.16.8 SENSE:FREQUency Subsystem	6.174
6.16.9 SENSE:LIST Subsystem	6.177
6.16.10 SENSE:MPOWer Subsystem	6.186
6.16.11 SENSE:POWer Subsystem	6.190
6.16.12 SENSE:ROSCillator Subsystem	6.199
6.16.13 SENSE:SCAN Subsystem	6.201
6.16.14 SENSE:SWEep Subsystem	6.204
6.16.15 SENSE:TV Subsystem	6.209
6.17 SOURce Subsystem	6.210
6.17.1 Internal Tracking Generator	6.210
6.17.2 SOURce:EXTeRnal Subsystem	6.213
6.18 STATus Subsystem	6.216
6.19 SYSTem Subsystem	6.225
6.20 TRACe Subsystem	6.236
6.20.1 General Trace Commands	6.236
6.20.2 Number and Format of the Measurement Values for the Different Operating Modes	6.239
6.20.3 TRACe:IQ Subsystem	6.242
6.21 TRIGger Subsystem	6.253
6.22 UNIT Subsystem	6.257
6.23 GPIB Commands of HP Models 856xE, 8566A/B, 8568A/B and 8594E	6.258
6.23.1 Introduction	6.258
6.23.2 Command Set of Models 8560E, 8561E, 8562E, 8563E, 8564E, 8565E, 8566A/B, 8568A/B, 8591E, 8594E, 71100C, 71200C, and 71209A	6.258
6.23.3 Special Features of the Syntax Parsing Algorithms for 8566A and 8568A Models	6.276
6.23.4 856x: Emulation of the Spurious Response Measurement Utility 85672A	6.277
6.23.4.1 General commands for Spurious	6.277
6.23.4.2 Commands for TOI-Measurement	6.277
6.23.4.3 Commands for Harmonic Distortion	6.277
6.23.4.4 Commands for Spurious	6.278

6.23.5 Special Behavior of Commands	6.279
6.23.6 Model-Dependent Default Settings	6.281
6.23.7 Data Output Formats	6.281
6.23.8 Trace Data Output Formats	6.282
6.23.9 Trace Data Input Formats	6.282
6.23.10 GPIB Status Reporting	6.282
6.24 Differences in GPIB Behavior between the FSP and the FSE Families of Instruments	6.283

6.1 Introduction

This chapter describes all remote control commands of the R&S ESCI in detail. For details on the notation of the remote control commands refer to [“Notation” on page 6.5](#).

Before sending a command sequence consisting of commands described in chapter 6, please make sure that the analyzer mode is active, by one of the following actions:

- Perform a preset (*RST).
- Use the `INST:SEL SAN` command.

The remote control commands are sorted according to the subsystem they belong to. The following subsystems are included in this chapter:

- [“Common Commands” on page 6.8](#)
- [“ABORt Subsystem” on page 6.11](#)
- [“CALCulate Subsystem” on page 6.12](#)
- [“CALibration Subsystem” on page 6.98](#)
- [“DIAGnostic Subsystem” on page 6.100](#)
- [“DISPlay Subsystem” on page 6.103](#)
- [“FORMat Subsystem” on page 6.113](#)
- [“HCOPY Subsystem” on page 6.114](#)
- [“INITiate Subsystem” on page 6.120](#)
- [“INPut Subsystem” on page 6.124](#)
- [“INSTrument Subsystem” on page 6.128](#)
- [“MMEMory Subsystem” on page 6.133](#)
- [“OUTPut Subsystem” on page 6.146](#)
- [“SENSe Subsystem” on page 6.147](#)
- [“SOURce Subsystem” on page 6.210](#)
- [“STATus Subsystem” on page 6.216](#)
- [“SYSTem Subsystem” on page 6.225](#)
- [“TRACe Subsystem” on page 6.236](#)
- [“TRIGger Subsystem” on page 6.253](#)
- [“UNIT Subsystem” on page 6.257](#)

An alphabetical list of all remote commands is provided at the end of this chapter in section [“Alphabetical List of Remote Commands” on page 6.330](#). Additionally, a subset of remote commands of HP models is supported. These commands are listed in section [“GPIB Commands of HP Models 856xE, 8566A/B, 8568A/B and 8594E” on page 6.258](#).

6.2 Notation

In the following sections, all commands implemented in the instrument are first listed in tables and then described in detail, arranged according to the command subsystems. The notation is adapted to the SCPI standard. The SCPI conformity information is included in the individual description of the commands.

Table of Commands

Command:	In the command column, the table provides an overview of the commands and their hierarchical arrangement (see indentations).
Parameter:	The parameter column indicates the requested parameters together with their specified range.
Unit:	The unit column indicates the base unit of the physical parameters.
Comment:	In the comment column an indication is made on: <ul style="list-style-type: none"> – whether the command does not have a query form, – whether the command has only one query form – whether the command is implemented only with a certain option of the instrument

Indentations The different levels of the SCPI command hierarchy are represented in the table by means of indentations to the right. The lower the level, the further the indentation to the right. Please note that the complete notation of the command always includes the higher levels as well.

Example:

`SENSe:FREQuency:CENTer` is represented in the table as follows:

```
SENSe  first level
      :FREQuency  second level
                :CENTer  third level
```

Individual description

The individual description contains the complete notation of the command. An example for each command, the *RST value and the SCPI information are included as well.

The operating modes for which a command can be used are indicated by the following abbreviations:

- R – receiver
- A – analyzer
- A-F – analyzer - frequency domain only
- A-T – analyzer - time domain only (zero span)



The receiver and analyzer modes are implemented in the base unit. For the other modes, the corresponding options are required.

Upper/lower case notation	Upper/lower case letters are used to mark the long or short form of the key words of a command in the description (see chapter “Remote Control – Basics”). The instrument itself does not distinguish between upper and lower case letters.
Special characters	<p> </p> <p>A selection of key words with an identical effect exists for several commands. These key words are indicated in the same line; they are separated by a vertical stroke. Only one of these key words needs to be included in the header of the command. The effect of the command is independent of which of the key words is used.</p> <p>Example:</p> <pre>SENSe:FREQuency:CW :FIXed</pre> <p>The two following commands with identical meaning can be created. They set the frequency of the fixed frequency signal to 1 kHz:</p> <pre>SENSe:FREQuency:CW 1E3 = SENSe:FREQuency:FIXed 1E3</pre> <p>A vertical stroke in parameter indications marks alternative possibilities in the sense of "or". The effect of the command is different, depending on which parameter is used.</p> <p>Example: Selection of the parameters for the command</p> <pre>DISPlay:FORMat FULL SPLit</pre> <p>If parameter FULL is selected, full screen is displayed, in the case of SPLit, split screen is displayed.</p> <p>[]</p> <p>Key words in square brackets can be omitted when composing the header (cf. chapter “Remote Control – Basics”, section “Optional key words” on page 5.10). The full command length must be accepted by the instrument for reasons of compatibility with the SCPI standards.</p> <p>Parameters in square brackets can be incorporated optionally in the command or omitted as well.</p> <p>{ }</p> <p>Parameters in braces can be incorporated optionally in the command, either not at all, once or several times.</p>
Description of parameters	Due to the standardization, the parameter section of SCPI commands consists always of the same syntactical elements. SCPI has therefore specified a series of definitions, which are used in the tables of commands. In the tables, these established definitions are indicated in angled brackets (< to >) and will be briefly explained in the following (see also chapter “Remote Control – Basics” , section “Parameters” on page 5.13).
<Boolean>	This key word refers to parameters which can adopt two states, "on" and "off". The "off" state may either be indicated by the key word OFF or by the numeric value 0, the "on" state is indicated by ON or any numeric value other than zero. Parameter queries are always returned the numeric value 0 or 1.

<numeric_value> <num>	<p>These key words mark parameters which may be entered as numeric values or be set using specific key words (character data).</p> <p>The following key words given below are permitted:</p> <ul style="list-style-type: none">– MINimum – This key word sets the parameter to the smallest possible value.– MAXimum – This key word sets the parameter to the largest possible value.– DEFault – This key word is used to reset the parameter to its default value.– UP – This key word increments the parameter value.– DOWN – This key word decrements the parameter value. <p>The numeric values associated to MAXimum/MINimum/DEFault can be queried by adding the corresponding key words to the command. They must be entered following the quotation mark.</p> <p>Example:</p> <pre>SENSe:FREQuency:CENTer? MAXimum</pre> <p>returns the maximum possible numeric value of the center frequency as result.</p>
<arbitrary block program data>	This key word is provided for commands the parameters of which consist of a binary data block.

6.3 Common Commands

The common commands are taken from the IEEE 488.2 (IEC 625-2) standard. A particular command has the same effect on different devices. The headers of these commands consist of an asterisk "*" followed by three letters. Many common commands refer to the status reporting system which is described in detail in chapter "Remote Control – Basics".

Command	Parameter	Function	Comment
*CAL?		Calibration Query	query only
*CLS		Clear Status	no query
*ESE	0 to 255	Event Status Enable	
*ESR?		Standard Event Status Query	query only
*IDN?		Identification Query	query only
*IST?		Individual Status Query	query only
*OPC		Operation Complete	
*OPT?		Option Identification Query	query only
*PCB	0 to 30	Pass Control Back	no query
*PRE	0 to 255	Parallel Poll Register Enable	
*PSC	0 1	Power On Status Clear	
*RST		Reset	no query
*SRE	0 to 255	Service Request Enable	
*STB?		Status Byte Query	query only
*TRG		Trigger	no query
*TST?		Self Test Query	query only
*WAI		Wait to continue	no query

*CAL?

CALIBRATION QUERY initiates a calibration of the instrument and subsequently queries the calibration status. Any responses > 0 indicate errors.

*CLS

CLEAR STATUS sets the status byte (STB), the standard event register (ESR) and the EVENT-part of the QUESTIONable and the OPERATION register to zero. The command does not alter the mask and transition parts of the registers. It clears the output buffer.

*ESE 0 to 255

EVENT STATUS ENABLE sets the event status enable register to the value indicated. The query form *ESE? returns the contents of the event status enable register in decimal form.

*ESR?

STANDARD EVENT STATUS QUERY returns the contents of the event status register in decimal form (0 to 255) and subsequently sets the register to zero.

***PRE 0 to 255**

PARALLEL POLL REGISTER ENABLE sets the parallel poll enable register to the indicated value. The query form ***PRE?** returns the contents of the parallel poll enable register in decimal form.

***PSC 0 | 1**

POWER ON STATUS CLEAR determines whether the contents of the ENABLE registers are preserved or reset during power-up.

***PSC = 0** causes the contents of the status registers to be preserved. Thus a service request can be generated when switching on the instrument, if the status registers ESE and SRE are suitably configured.

***PSC <> 0** Resets the registers.

The query form ***PSC?** reads out the contents of the power-on-status-clear flag. The response can be 0 or 1.

***RST**

RESET sets the instrument to a defined default status. The command essentially corresponds to pressing the *PRESET* key. The default setting is indicated in the description of the commands.

***SRE 0 to 255**

SERVICE REQUEST ENABLE sets the service request enable register to the indicated value. Bit 6 (MSS mask bit) remains 0. This command determines under which conditions a service request is generated. The query form ***SRE?** reads the contents of the service request enable register in decimal form. Bit 6 is always 0.

***STB?**

READ STATUS BYTE QUERY reads out the contents of the status byte in decimal form.

***TRG**

TRIGGER initiates all actions in the currently active test screen expecting a trigger event. This command corresponds to `INITiate:IMMediate` (cf. section [“TRIGger Subsystem” on page 6.253](#)).

***TST?**

SELF TEST QUERY initiates the selftest of the instrument and outputs an error code in decimal form (0 = no error).

***WAI**

WAIT-to-CONTINUE permits servicing of subsequent commands only after all preceding commands have been executed and all signals have settled (cf. section [“*OPC” on page 6.9](#) and chapter [“Remote Control – Basics”](#)).

6.4 ABORt Subsystem

The ABORt subsystem contains the commands for aborting triggered actions. An action can be triggered again immediately after being aborted. All commands trigger events, and therefore they have no *RST value.

ABORt

This command aborts a current measurement and resets the trigger system.

Example: "ABOR;INIT:IMM"

Characteristics: *RST value: 0
SCPI: conform

Mode: R, A

HOLD

This command interrupts a current scan measurement. The scan is resumed by "[INITiate<1|2>\[:IMMediate\]](#)" on page 6.121

Example: "HOLD"
'interrupts the current scan measurement

Characteristics: *RST value: -
SCPI: conform

Mode: R

6.5 CALCulate Subsystem

The CALCulate subsystem contains commands for converting instrument data, transforming and carrying out corrections. These functions are carried out subsequent to data acquisition, i.e. following the SENSE subsystem.

The numeric suffix is used in CALCulate to make the distinction between the two measurement windows SCREEN A and SCREEN B:

CALCulate1 = Screen A

CALCulate2 = Screen B.

For commands without suffix, screen A is selected automatically.

Full Screen The settings are valid for the measurement window selected with the numeric suffix. They become effective as soon as the corresponding measurement window has been selected as active measurement window using the command `DISPLay[:WINDow<1|2>]:SElect`. Triggering measurements and querying measured values is possible only in the active measurement window.

Split Screen The settings are valid for the measurement window selected by means of the numeric suffix and become effective immediately.



In receiver mode, the marker can be activated only for the scan display (numeric suffix 2) and after a scan is carried out.

6.5.1 CALCulate:DELTamarker Subsystem

The CALCulate:DELTamarker subsystem controls the delta-marker functions in the instrument.

The measurement windows are selected via CALCulate1 (screen A) or 2 (screen B).

CALCulate<1|2>:DELTamarker<1...4>[:STATe] ON | OFF

This command switches on and off the delta marker if delta marker 1 is selected. If marker 2, 3 or 4 is selected and used as a marker, it is switched to delta marker mode. If the corresponding marker is not activated, it will be activated and positioned on the maximum of the measurement curve. If no numeric suffix is indicated, delta marker 1 is selected automatically.

The measurement windows are selected via CALCulate1 (screen A) or 2 (screen B).

Example: "CALC:DELT3 ON"
'Switches marker 3 in screen A to delta marker mode.

Characteristics: *RST value: OFF
SCPI: device-specific

Mode: R, A

CALCulate<1|2>:DELTamarker<1...4>:MODE ABSolute | RELative

This command switches between relative and absolute frequency input of the delta marker (or time with span = 0). It affects all delta markers independent of the measurement window.

Example: "CALC:DELT:MODE ABS"
'Switches the frequency/time indication for all delta markers to absolute values.
"CALC:DELT:MODE REL"
'Switches the frequency/time indication for all delta markers to relative to marker 1.

Characteristics: *RST value: REL
SCPI: device-specific

Mode: R, A

CALCulate<1|2>:DELTamarker<1...4>:AOFF

This command switches off all active delta markers.

The measurement windows are selected via CALCulate1 (screen A) or 2 (screen B).

Example: "CALC:DELT:AOFF"
'Switches off all delta markers in screen A.

Characteristics: *RST value: -
SCPI: device-specific

Mode: R, A

This command is an event and therefore has no *RST value and no query.

CALCulate<1|2>:DELTamarker<1...4>:TRACe 1 to 3

This command assigns the selected delta marker to the indicated measurement curve. The selected measurement curve must be active, i.e. its state must be different from "BLANK".

The measurement windows are selected via CALCulate1 (screen A) or 2 (screen B).

Example: "CALC:DELT3:TRAC 2"
'Assigns deltamarker 3 to trace 2 in screen A.
"CALC2:DELT:TRAC 3"
'Assigns delta marker 1 to trace 3 in screen B.

Characteristics: *RST value: -
SCPI: device-specific

Mode: R, A

CALCulate<1|2>:DELTamarker<1...4>:X 0 to MAX (frequency | sweep time)

This command positions the selected delta marker in the indicated measurement window to the indicated frequency (span > 0), time (span = 0) or level (APD measurement = ON or CCDF measurement = ON). The input is in absolute values or relative to marker 1 depending on the command CALCulate:DELTamarker:MODE. If the reference fixed measurement (CALCulate:DELTamarker:FUNCTion:FIXed:STATE ON) is active, relative values refer to the reference position are entered. The query always returns absolute values.

Example: "CALC:DELT:MOD REL"
'Switches the input for all delta markers to relative to marker 1.
"CALC:DELT2:X 10.7MHz"
'Positions delta marker 2 in screen A 10.7 MHz to the right of marker 1.
"CALC2:DELT:X?"
'Outputs the absolute frequency/time of delta marker 1 in screen B
"CALC2:DELT:X:REL?"
'Outputs the relative frequency/time/level of delta marker 1 in screen B

Characteristics: *RST value: -
SCPI: device-specific

Mode: R, A

CALCulate<1|2>:DELTamarker<1...4>:X:RELative?

This command queries the frequency (span > 0) or time (span = 0) of the selected delta marker relative to marker 1 or to the reference position (for CALCulate:DELTamarker:FUNCTion:FIXed:STATE ON). The command activates the corresponding delta marker, if necessary.

Example: "CALC:DELT3:X:REL?"
'Outputs the frequency of delta marker 3 in screen B relative to marker 1 or relative to the reference position.

Characteristics: *RST value: -
SCPI: device-specific

Mode: R, A

CALCulate<1|2>:DELTamarker<1...4>:Y?

This command queries the measured value of the selected delta marker in the indicated measurement window. The corresponding delta marker will be activated, if necessary. The output is always a relative value referred to marker 1 or to the reference position (reference fixed active).

To obtain a valid query result, a complete sweep with synchronization to the sweep end must be performed between the activation of the delta marker and the query of the y value. This is only possible in single-sweep mode. In receiver mode, the markers can be only activated after a scan is carried out.

Depending on the unit defined with `CALC:UNIT` or on the activated measuring functions, the query result is output in the units below:

- DBM | DBPW | DBUV | DBMV | DBUA: Output unit DB
- WATT | VOLT | AMPere: Output unit W | V | A
- Statistics function (APD or CCDF) on: Dimensionless output

Example:

```
"INIT:CONT OFF"
'Switches to single-sweep mode.

"CALC:DELT2 ON"
'Switches on delta marker 2 in screen A.

"INIT;*WAI"
'Starts a sweep and waits for its end.

"CALC:DELT2:Y?"
'Outputs measurement value of delta marker 2 in screen A.
```

Characteristics: *RST value: -
SCPI: device-specific

Mode: R, A

CALCulate<1|2>:DELTamarker<1...4>:MAXimum[:PEAK]

This command positions the specified delta marker to the current maximum value of the trace. If necessary, the corresponding delta marker will be activated first.

Example:

```
"CALC2:DELT3:MAX"
'Sets delta marker 3 in screen B to the maximum value of the associated trace.
```

Characteristics: *RST value: -
SCPI: device-specific

Mode: R, A

This command is an event and therefore has no *RST value and no query.

CALCulate<1|2>:DELTamarker<1...4>:MAXimum:NEXT

This command positions the specified delta marker to the next smaller maximum value of the trace. The corresponding delta marker will be activated first, if necessary.

Example:

```
"CALC1:DELT2:MAX:NEXT"
'Sets delta marker 2 in screen A to the next smaller maximum value.
```

Characteristics: *RST value: -
SCPI: device-specific

Mode: R, A

This command is an event and therefore has no *RST value and no query.

CALCulate<1|2>:DELTamarker<1...4>:MAXimum:RIGHT

This command positions the specified delta marker to the next smaller maximum value to the right of the current value (i.e. ascending X values). The corresponding delta marker is activated first, if necessary.

Example: "CALC2:DELT:MAX:RIGHT"
'Sets delta marker 1 in screen B to the next smaller maximum value to the right of the current value.

Characteristics: *RST value: -
SCPI: device-specific

Mode: R, A

This command is an event and therefore has no *RST value and no query.

CALCulate<1|2>:DELTamarker<1...4>:MAXimum:LEFT

This command positions the specified delta marker to the next smaller maximum value to the left of the current value (i.e. descending X values). The corresponding delta marker will be activated first, if necessary.

Example: "CALC:DELT:MAX:LEFT"
'Sets delta marker 1 in screen A to the next smaller maximum value to the left of the current value.

Characteristics: *RST value: -
SCPI: device-specific

Mode: R, A

This command is an event and therefore has no *RST value and no query.

CALCulate<1|2>:DELTamarker<1...4>:MINimum[:PEAK]

This command positions the specified delta marker to the current minimum value of the trace. The corresponding delta marker will be activated first, if necessary.

Example: "CALC2:DELT3:MIN"
'Sets delta marker 3 in screen B to the minimum value of the associated trace.

Characteristics: *RST value: -
SCPI: device-specific

Mode: R, A

This command is an event and therefore has no *RST value and no query.

CALCulate<1|2>:DELTamarker<1...4>:MINimum:NEXT

This command positions the specified delta marker to the next higher minimum value of the trace. The corresponding delta marker will be activated first, if necessary.

Example: "CALC1:DELT2:MIN:NEXT"
'Sets delta marker 2 in screen A to the next higher minimum value.

Characteristics: *RST value: -
SCPI: device-specific

Mode: R, A

This command is an event and therefore has no *RST value and no query.

CALCulate<1|2>:DELTamarker<1...4>:MINimum:RIGHT

This command positions the specified delta marker to the next higher minimum value to the right of the current value (i.e. ascending X values). The corresponding delta marker will be activated first, if necessary.

Example: "CALC2:DELT:MIN:RIGH"
'Sets delta marker 1 in screen B to the next higher minimum value to the right of the current value.

Characteristics: *RST value: -
SCPI: device-specific

Mode: R, A

This command is an event and therefore has no *RST value and no query.

CALCulate<1|2>:DELTamarker<1...4>:MINimum:LEFT

This command positions the specified delta marker to the next higher minimum value to the left of the current value (i.e. descending X values). The corresponding delta marker will be activated first, if necessary.

Example: "CALC:DELT:MIN:LEFT"
'Sets delta marker 1 in screen A to the next higher minimum to the left of the current value.

Characteristics: *RST value: -
SCPI: device-specific

Mode: R, A

This command is an event and therefore has no *RST value and no query.

CALCulate<1|2>:DELTamarker<1...4>:LINK ON | OFF

This command switches on and off a link of delta marker 1 to marker 1. If the link is switched on and the x-axis value of the marker 1 is changed, the delta marker 1 will follow on the same x-position.

The suffix at DELTmarker can only be 1 or not present, because the functionality is only available for marker 1 and delta marker 1.

Example: "CALC1:DELT1:LINK ON"
Switches the link of marker1/delta marker 1 on.

Characteristics: *RST value: OFF
SCPI: device-specific

Mode: R, A

CALCulate<1|2>:DELTamarker<1...4>:FUNction:FIXed[:STATe] ON | OFF

This command switches the relative measurement to a fixed reference value on or off. Marker 1 will be activated previously and a peak search will be performed, if necessary. If marker 1 is activated, its position becomes the reference point for the measurement. The reference point can then be modified with commands CALCulate:DELTamarker:FUNction:FIXed:RPOint:X and to:RPOint:Y independently of the position of marker 1 and of a trace. It is valid for all delta markers in the selected measurement window as long as the function is active.

Example: "CALC2:DELT:FUNC:FIX ON"
'Switches on the measurement with fixed reference value for all delta markers in screen B.

"CALC2:DELT:FUNC:FIX:RPO:X 128 MHZ"
'Sets the reference frequency in screen B to 128 MHz.

"CALC2:DELT:FUNC:FIX:RPO:Y 30 DBM"
'Sets the reference level in screen B to +30 dBm

Characteristics: *RST value: OFF
SCPI: device-specific.

Mode: A

CALCulate<1|2>:DELTamarker<1...4>:FUNCTION:FIXed:RPOint:MAXimum[:PEAK] <numeric_value>

This command sets the reference point level for all delta markers in the selected measurement window for a measurement with fixed reference point (CALC:DELT:FUNC:FIX:STAT ON) to the peak of the selected trace.

For phase noise measurements (CALCulate:DELTamarker:FUNCTION:PNOise:STATe ON), the command defines a new reference point level for delta marker 2 in the selected measurement window.

Example: "CALC:DELT:FUNC:FIX:RPO:MAX"
'Sets the reference point level for the delta marker in screen A to the peak of the trace.

Characteristics: *RST value: -
SCPI: device-specific

Mode: A

This command is an event and therefore has no *RST value and no query.

CALCulate<1|2>:DELTamarker<1...4>:FUNCTION:FIXed:RPOint:Y <numeric_value>

This command defines a new reference point level for all delta markers in the selected measurement window for a measurement with fixed reference point. (CALCulate:DELTamarker:FUNCTION:FIXed:STATe ON).

For phase noise measurements (CALCulate:DELTamarker:FUNCTION:PNOise:STATe ON), the command defines a new reference point level for delta marker 2 in the selected measurement window.

Example: "CALC:DELT:FUNC:FIX:RPO:Y -10dBm"
'Sets the reference point level for delta markers in screen A to -10 dBm.

Characteristics: *RST value: - (FUNCTION:FIXed[:STATe] is set to OFF)
SCPI: device-specific

Mode: A

CALCulate<1|2>:DELTamarker<1...4>:FUNCTION:FIXed:RPOint:Y:OFFSet <numeric_value>

This command defines an additional level offset for the measurement with fixed reference value (CALCulate:DELTamarker:FUNCTION:FIXed:STATe ON). For this measurement, the offset is included in the display of all delta markers of the selected measurement window.

For phase noise measurements (CALCulate:DELTamarker:FUNCTION:PNOise:STATe ON), the command defines an additional level offset which is included in the display of delta marker 2 in the selected measurement window.

Example: "CALC:DELT:FUNC:FIX:RPO:Y:OFFS 10dB"
 'Sets the level offset for the measurement with fixed reference value or the phase noise measurement in screen A to 10 dB.

Characteristics: *RST value: 0 dB
 SCPI: device-specific

Mode: A

CALCulate<1|2>:DELTamarker<1...4>:FUNCTION:FIXed:RPOint:X <numeric_value>

This command defines a new reference frequency (span > 0) or time (span = 0) for all delta markers in the selected measurement window for a measurement with fixed reference value (CALCulate:DELTamarker:FUNCTION:FIXed:STATE ON).

For phase noise measurements (CALCulate:DELTamarker:FUNCTION:PNOise:STATE ON), the command defines a new reference frequency or time for delta marker 2 in the selected measurement window.

Example: "CALC2:DELT:FUNC:FIX:RPO:X 128MHz"
 'Sets the reference frequency in screen B to 128 MHz.

Characteristics: *RST value: - (FUNCTION:FIXed[:STATE] is set to OFF)
 SCPI: device-specific

Mode: A

CALCulate<1|2>:DELTamarker<1...4>:FUNCTION:PNOise:AUTO ON | OFF

This command adds an automatic peak search action for the reference fixed marker 1 at the end of each particular sweep. This function may be used for tracking of a drifting source whilst phase noise measurement. The delta marker 2 which shows the phase noise measurement result keeps the delta frequency value. Therefore the phase noise measurement in a certain offset is valid although the source is drifting. Only when the marker 2 is reaching the border of the span the delta marker value is adjusted to be within the span. Choose a larger span in such situations.

Example: "CALC:DELT:FUNC:PNO 1"
 'Switches the phase noise measurement on.
 "CALC:DELT:FUNC:PNO:AUTO ON"
 'Activates the automatic peak search.

Characteristics: *RST value: OFF
 SCPI: device-specific

Mode: A

The suffix at DELTmarker is ignored.

CALCulate<1|2>:DELTamarker<1...4>:FUNCTION:PNOise[:STATE] ON | OFF

This command switches on or off the phase noise measurement with all active delta markers in the selected measurement window. The correction values for the bandwidth and the log amplifier are taken into account in the measurement.

Marker 1 will be activated, if necessary, and a peak search will be performed. If marker 1 is activated, its position becomes the reference point for the measurement.

The reference point can then be modified with commands CALCulate:DELTamarker:FUNCTION:FIXed:RPOint:X and ...:RPOint:Y independently of the position of marker 1 and of a trace (the same commands used for the measurement with fixed reference point).

The numeric suffix <1...4> with DELTmarker is not relevant for this command.

- Example:** "CALC:DELT:FUNC:PNO ON"
'Switches on the phase noise measurement with all delta markers in screen A.
- "CALC:DELT:FUNC:FIX:RPO:X 128 MHZ"
'Sets the reference frequency to 128 MHz.
- "CALC:DELT:FUNC:FIX:RPO:Y 30 DBM"
'Sets the reference level to +30 dBm
- Characteristics:** *RST value: OFF
SCPI: device-specific
- Mode:** A

CALCulate<1|2>:DELTamarker<1...4>:FUNCtion:PNOise:RESult?

This command queries the result of the phase noise measurement in the selected measurement window. The measurement will be switched on, if necessary.

- Example:** "CALC:DELT:FUNC:PNO:RES?"
'Outputs the result of phase noise measurement of the selected delta marker in screen A.
- Characteristics:** *RST value: -
SCPI: device-specific

Mode: A

This command is only a query and therefore has no *RST value.

6.5.2 CALCulate:ESpectrum Subsystem

The following chapter describes remote control commands that configure the list evaluation for the Spectrum Emission Mask measurement.

CALCulate<1|2>:ESpectrum:PSEarch|PEAKsearch:AUTO ON | OFF

This command activates or deactivates the list evaluation of the Spectrum Emission Mask measurement.

Example: "CALC:ESP:PSE:AUTO OFF"
'Deactivates the list evaluation

Characteristics: RST value: ON
SCPI: device-specific

Mode: A

:CALCulate<1|2>:ESpectrum:PSEarch | PEAKsearch:MARGin -200dB ... +200dB

This command sets the margin used for the limit check/peak search of the Spectrum Emission Mask measurement.

Example: "CALC:ESP:PSE:MARG 10"
'sets the margin to 10 dB

Characteristics: *RST value: 6 dB
SCPI: device-specific

Mode: A

6.5.3 CALCulate:LIMit Subsystem

The CALCulate:LIMit subsystem consists of the limit lines and the corresponding limit checks. In receiver mode, upper limit lines can be defined. In analyzer mode, limit lines can be defined as upper or lower limit lines. The individual Y values of the limit lines correspond to the values of the x-axis (CONTROL). The number of X and Y values must be identical.

In analyzer and receiver mode, 8 limit lines can be active at the same time (marked by LIMIT1 to LIMIT8) in screen A and/or screen B. The measurement windows is selected via CALCulate 1 (screen A) or 2 (screen B). The limit check can be switched on separately for each measurement screen and limit line. WINDow1 corresponds to screen A, WINDow2 to screen B.

Each limit line can be assigned a name (max. 8 letters) under which the line is stored in the instrument. An explanatory comment can also be given for each line (max. 40 characters).

Example (analyzer mode):

Definition and use of a new limit line 5 for trace 2 in screen A and trace 1 in screen B with the following features:

- upper limit line
- absolute x-axis in the frequency domain
- 5 ref. values: 126 MHz/-40 dB, 127 MHz/-40 dB, 128 MHz/-20 dB, 129 MHz/-40 dB, 130 MHz/-40 dB
- relative y-axis with unit dB
- absolute threshold value at -35 dBm
- no safety margin

Definition of the line (example for analyzer mode):

1. Defining the name: `CALC:LIM5:NAME 'TEST1'`
2. Entering the comment: `CALC:LIM5:COMM 'Upper limit line'`
3. Associated trace in screen A: `CALC1:LIM5:TRAC 2`
4. Associated trace in screen B: `CALC2:LIM5:TRAC 1`
5. Defining the x-axis range: `CALC:LIM5:CONT:DOM FREQ`
6. Defining the x-axis scaling: `CALC:LIM5:CONT:MODE ABS`
7. Defining the y-axis unit: `CALC:LIM5:UNIT DB`
8. Defining the y-axis scaling: `CALC:LIM5:UPP:MODE REL`
9. Defining the x-axis values: `CALC:LIM5:CONT 126MHZ, 127MHZ, 128MHZ, 129MHZ, 130MHZ`
10. Defining the y values: `CALC:LIM5:UPP -40, -40, -30, -40, -40`
11. Defining the y threshold value: `CALC:LIM5:UPP:THR -35DBM`

The definition of the safety margin and shifting in X and/or Y direction can take place as from here (see commands below).

Switching on and evaluating the line in screen A (example for analyzer mode):

1. Switching on the line in screen A: `CALC1:LIM5:UPP:STAT ON`
2. Switching on the limit check in screen A: `CALC1:LIM5:STAT ON`
3. Starting a new measurement with synchronization: `INIT;*WAI`
4. Querying the limit check result: `CALC1:LIM5:FAIL?`

Switching on and evaluating the line in screen B is performed in the same way by using `CALC2` instead of `CALC1`.

CALCulate<1|2>:LIMit<1...8>:ACTive?

This commands queries the names of all active limit lines. The numeric suffixes at `CALCulate<1|2>` and `LIMit<1...8>` are ignored.

Return value: The return values are sorted in alphabetic order. If no limit line is active, an empty string is returned.

Example: `"CALC:LIM:ACT?"`

Characteristics: *RST value: --
SCPI: device-specific

This command is a query only and therefore has no *RST value.

CALCulate<1|2>:LIMit<1...8>:CATalog?

This command queries all the names of the limit lines saved on the hard disc.

Up to 8 limit lines can be defined at the same time. The numeric suffixes `<1|2>` of `CALCulate` indicate the measurement window.

Return value: The syntax of the return values is:
<sum of file length of all following files>,<free spaces on hard disc>,<1st file name>,<1st file length>,<2nd file name>,<2 nd file length>,...,<n th file name>,<nth file length>

Example: `"CALC:LIM:CAT?"`

Characteristics: *RST value: -
SCPI: device-specific

This command is a query only and therefore has no *RST value.

CALCulate<1|2>:LIMit<1...8>:TRACe 1 to 3

This command assigns a limit line to a trace.

Up to 8 limit lines can be defined at the same time. The numeric suffixes `<1|2>` of `CALCulate` indicate the measurement window.

Example: `"CALC:LIM2:TRAC 3"`
'Assigns limit line 2 to trace 3 in screen A.

`"CALC2:LIM2:TRAC 1"`
'Assigns limit line 2 to trace 1 in screen B at the same time.

Characteristics: *RST value: 1
SCPI: device-specific

Mode: R, A

CALCulate<1|2>:LIMit<1...8>:STATe ON | OFF

This command switches on or off the limit check for the selected limit line.

The result of the limit check can be queried with **CALCulate<1|2>:LIMit<1...8>:FAIL?**.

Up to 8 limit lines can be defined at the same time. The numeric suffixes <1|2> of CALCulate indicate the measurement window.

Example: "CALC:LIM:STAT ON"
'Switches on the limit check for limit line 1 in screen A.

"CALC2:LIM:STAT OFF"
'Switches off the limit check for limit line 1 in screen B.

Characteristics: *RST value: OFF
SCPI: conform

Mode: R, A

CALCulate<1|2>:LIMit<1...8>:UNIT AMPere | DB | DBM | DBMV | DBPT | DBPW | DBUA | DBUA_M | DBUV | DBUV_M | DBV | DEG | HZ | PCT | RAD | S | UNITLESS | VOLT | WATT

This command defines the unit for the associated limit line.

The definition is valid regardless of the measurement window.

Specification of the DB unit automatically switches the limit line over to relative mode. Units other than DB cause the limit line to switch over to absolute mode.

Example: "CALC:LIM4:UNIT DBUV"
'Sets the unit of limit line 4 to dBµV.

Characteristics: *RST value: DBM
SCPI: device-specific

Mode: R, A

CALCulate<1|2>:LIMit<1...8>:FAIL?

This command queries the result of the limit check of the limit line. It should be noted that a complete sweep must have been performed for obtaining a valid result. A synchronization with *OPC, *OPC? or *WAI should therefore be provided.

Up to 8 limit lines can be defined at the same time. The numeric suffixes <1|2> of CALCulate indicate the measurement window. The result of the limit check responds with 0 for PASS, 1 for FAIL, and 2 for MARGIN.

In receiver mode, this command is not available.

Example: "INIT;*WAI"
'Starts a new sweep and waits for its end.

"CALC2:LIM3:FAIL?"
'Queries the result of the check for limit line 3 in screen B.

Characteristics: *RST value: -
SCPI: conform

Mode: A

CALCulate<1|2>:LIMit<1...8>:CLEar[:IMMediate]

This command deletes the result of the current limit check for all limit lines.

Up to 8 limit lines can be defined at the same time. The numeric suffixes <1|2> of CALCulate indicate the measurement window.

This command is an event and therefore has no *RST value.

Example: "CALC:LIM:CLE"
'Deletes the result of the limit check in screen A.'

Characteristics: *RST value: -
SCPI: conform

Mode: A

CALCulate<1|2>:LIMit<1...8>:COMMeNt <string>

This command defines a comment for the limit line selected (max. 40 characters).

Up to 8 limit lines can be defined at the same time. The comment is independent from the measurement window.

Example: "CALC:LIM5:COMM 'Upper limit for spectrum'"
'Defines the comment for limit line 5.'

Characteristics: *RST value: blank comment
SCPI: device-specific

Mode: R, A

CALCulate<1|2>:LIMit<1...8>:COpy 1 to 8 | <name>

This command copies one limit line onto another one.

Up to 8 limit lines can be defined at the same time. The command is independent of the measurement window.

Parameter: 1 to n ::= number of the new limit line or
<name> ::= name of the new limit line given as a string

Example: "CALC:LIM1:COpy 2"
'Copies limit line 1 to line 2.'

"CALC:LIM1:COpy 'FM2'"
'Copies limit line 1 to a new line named 'FM2'.'

Characteristics: *RST value: --
SCPI: device-specific

Mode: R, A

This command is an event and therefore has no *RST value and no query.

CALCulate<1|2>:LIMit<1...8>:NAME <name of limit line>

This command assigns a name to a limit line. If it does not exist already, a limit line with this name is created.

The name of the limit line may contain a maximum of 8 characters.

Up to 8 limit lines can be defined at the same time. The command is independent of the measurement window.

Example: "CALC:LIM1:NAME 'FM1'"
 'Assigns the name 'FM1' to limit line 1.

Characteristics: *RST value: 'REM1' to 'REM8' for lines 1 to 8
 SCPI: device-specific

Mode: R, A

CALCulate<1|2>:LIMit<1...8>:DELeTe

This command deletes the selected limit line.

Up to 8 limit lines can be defined at the same time. The command is independent of the measurement window.

Example: "CALC:LIM1:DEL"
 'Deletes limit line 1.

Characteristics: *RST value: --
 SCPI: device-specific

Mode: R, A

This command is an event and therefore has no *RST value and no query.

6.5.3.1 CALCulate:LIMit:ACPower Subsystem

The CALCulate:LIMit:ACPower subsystem defines the limit check for adjacent channel power measurement.

CALCulate<1|2>:LIMit<1...8>:ACPower[:STATe] ON | OFF

This command switches on and off the limit check for adjacent channel power measurements in the selected measurement window. The commands `CALCulate:LIMit:ACPower:ACHannel:STATe` or `CALCulate:LIMit:ACPower:ALternate:STATe` must be used in addition to specify whether the limit check is to be performed for the upper/lower adjacent channel or for the alternate adjacent channels.

The numeric suffixes <1...8> are irrelevant for this command.

Example: "CALC:LIM:ACP ON"
'Switches on the ACP limit check in screen A.

Characteristics: *RST value: OFF
SCPI: device-specific

Mode: A

CALCulate<1|2>:LIMit<1...8>:ACPower:ACHannel[:RELative] 0 to 100dB, 0 to 100dB

This command defines the relative limit of the upper/lower adjacent channel for adjacent channel power measurements in the selected measurement window. The reference value for the relative limit value is the measured channel power.

It should be noted that the relative limit value has no effect on the limit check as soon as it is below the absolute limit value defined with `CALCulate:LIMit:ACPower:ACHannel:ABSolute`. This mechanism allows automatic checking of the absolute basic values of adjacent channel power as defined in mobile radio standards.

The numeric suffixes <1...8> are irrelevant for this command.

Parameter: The first numeric value is the limit for the upper (lower) adjacent channel. The second value is ignored but must be indicated for reasons of compatibility with the FSE family.

Example: "CALC:LIM:ACP:ACH 30DB, 30DB"
'Sets the relative limit value in screen A for the power in the lower and upper adjacent channel to 30 dB below the channel power.

Characteristics: *RST value: 0 dB
SCPI: device-specific

Mode: A

CALCulate<1|2>:LIMit<1...8>:ACPower:ACHannel[:RELative]:STATe ON | OFF

This command activates the limit check for the relative limit value of the adjacent channel when adjacent channel power measurement is performed. Before the command, the limit check must be activated using `CALCulate:LIMit:ACPower:STATe ON`.

The result can be queried with `CALCulate:LIMit:ACPower:ACHannel:RESult?`. It should be noted that a complete measurement must be performed between switching on the limit check and the result query, since otherwise no valid results are available.

The numeric suffixes <1...8> are irrelevant for this command.

Example: "CALC:LIM:ACP:ACH 30DB, 30DB"
 'Sets the relative limit value in screen A for the power in the lower and upper adjacent channel to 30 dB below the channel power.

"CALC:LIM:ACP:ACH:ABS -35DBM, -35DBM"
 'Sets the absolute limit value in screen A for the power in the lower and upper adjacent channel to -35 dBm.

"CALC:LIM:ACP ON"
 'Switches on globally the limit check for the channel/adjacent channel measurement in screen A.

"CALC:LIM:ACP:ACH:REL:STAT ON"
 'Switches on the check of the relative limit values for adjacent channels in screen A.

"CALC:LIM:ACP:ACH:ABS:STAT ON"
 'Switches on the check of absolute limit values for the adjacent channels in screen A.

"INIT;*WAI"
 'Starts a new measurement and waits for the sweep end.

"CALC:LIM:ACP:ACH:RES?"
 'Queries the limit check result in the adjacent channels in screen A.

Characteristics: *RST value: OFF
 SCPI: device-specific

Mode: A

CALCulate<1|2>:LIMit<1...8>:ACPpower:ACHannel:ABSolute -200DBM to 200DBM, -200 to 200DBM

This command defines the absolute limit value for the lower/upper adjacent channel during adjacent channel power measurement (Adjacent Channel Power) in the selected measurement window.

It should be noted that the absolute limit value has no effect on the limit check as soon as it is below the relative limit value defined with `CALCulate:LIMit:ACPpower:ACHannel:RELative`. This mechanism allows automatic checking of the absolute basic values of adjacent channel power as defined in mobile radio standards.

The numeric suffixes <1...8> in `LIMit` are irrelevant for this command.

Parameter: The first value is the limit for the lower and the upper adjacent channel. The second limit value is ignored but must be indicated for reasons of compatibility with the FSE family.

Example: "CALC:LIM:ACP:ACH:ABS -35DBM, -35DBM"
 'Sets the absolute limit value in screen A for the power in the lower and upper adjacent channel to -35 dBm.

Characteristics: *RST value: -200DBM
 SCPI: device-specific

Mode: A

CALCulate<1|2>:LIMit<1...8>:ACPpower:ACHannel:ABSolute:STATe ON | OFF

This command activates the limit check for the adjacent channel when adjacent channel power measurement (Adjacent Channel Power) is performed. Before the command, the limit check for the channel/adjacent channel measurement must be globally switched on using `CALC:LIM:ACP ON`.

The result can be queried with `CALCulate:LIMit:ACPpower:ACHannel:RESult?`. It should be noted that a complete measurement must be performed between switching on the limit check and the result query, since otherwise no valid results are available.

The numeric suffixes <1...8> in LIMit are irrelevant for this command.

Example:

```
"CALC:LIM:ACP:ACH 30DB, 30DB"
```

'Sets the relative limit value in screen A for the power in the lower and upper adjacent channel to 30 dB below the channel power.

```
"CALC:LIM:ACP:ACH:ABS -35DBM, -35DBM"
```

'Sets the absolute limit value in screen A for the power in the lower and upper adjacent channel to -35 dBm.

```
"CALC:LIM:ACP ON"
```

'Switches on globally the limit check for the channel/adjacent channel measurement in screen A.

```
"CALC:LIM:ACP:ACH:REL:STAT ON"
```

'Switches on the check of the relative limit values for adjacent channels in screen A.

```
"CALC:LIM:ACP:ACH:ABS:STAT ON"
```

'Switches on the check of absolute limit values for the adjacent channels in screen A.

```
"INIT;*WAI"
```

'Starts a new measurement and waits for the sweep end.

```
"CALC:LIM:ACP:ACH:RES?"
```

'Queries the limit check result in the adjacent channels in screen A.

Characteristics: *RST value: OFF
SCPI: device-specific

Mode: A

CALCulate<1|2>:LIMit<1...8>:ACPpower:ACHannel:RESult?

This command queries the result of the limit check for the upper/lower adjacent channel in the selected measurement window when adjacent channel power measurement is performed.

If the power measurement of the adjacent channel is switched off, the command produces a query error.

The numeric suffixes <1...8> are irrelevant for this command.

Parameter: The result is returned in the form <result>, <result> where <result> = PASSED | FAILED, and where the first returned value denotes the lower, the second denotes the upper adjacent channel.

Example:

```
"CALC:LIM:ACP:ACH 30DB, 30DB"
```

'Sets the relative limit value in screen A for the power in the lower and upper adjacent channel to 30 dB below the channel power.

```
"CALC:LIM:ACP:ACH:ABS -35DBM, -35DBM"
```

'Sets the absolute limit value in screen A for the power in the lower and upper adjacent channel to -35 dB.

```
"CALC:LIM:ACP ON"
```

'Switches on globally the limit check for the channel/adjacent channel measurement in screen A.

```
"CALC:LIM:ACP:ACH:STAT ON"
```

'Switches on the limit check for the adjacent channels in screen A.

```
"INIT;*WAI"
```

'Starts a new measurement and waits for the sweep end.

```
"CALC:LIM:ACP:ACH:RES?"
```

'Queries the limit check result in the adjacent channels in screen A.

Characteristics: *RST value: --
SCPI: device-specific

Mode: A

This command is a query and therefore has no *RST value.

CALCulate<1|2>:LIMit<1...8>:ACPpower:ALTErnate<1 to 11>[:RELative] 0 to 100dB, 0 to 100dB.

This command defines the limit for the alternate adjacent channels in the selected measurement window for adjacent channel power measurements. The reference value for the relative limit value is the measured channel power.

The numeric suffix after ALTErnate<1 to 11> denotes the alternate channel. The numeric suffixes <1...8> are irrelevant for this command.

It should be noted that the relative limit value has no effect on the limit check as soon as it is below the absolute limit defined with CALCulate:LIMit:ACPpower:ALTErnate<1 to 11>:ABSolute. This mechanism allows automatic checking of the absolute basic values of adjacent channel power as defined in mobile radio standards.

Parameter: The first value is the limit for the lower and the upper alternate adjacent channel. The second limit value is ignored but must be indicated for reasons of compatibility with the FSE family.

Example:

```
"CALC:LIM:ACP:ALT2 30DB, 30DB"
```

'Sets the relative limit value in screen A for the power in the lower and upper alternate adjacent channel to 30 dB below the channel power.

Characteristics: *RST value: 0DB
SCPI: device-specific

Mode: A

CALCulate<1|2>:LIMit<1...8>:ACPpower:ALTErnate<1 to 11>[:RELative]:STATe ON | OFF

This command activates the limit check for the alternate adjacent channels in the selected measurement window for adjacent channel power measurements. Before the command, the limit check must be activated using CALCulate:LIMit:ACPpower:STATe ON.

The numeric suffix after ALTErnate<1 to 11> denotes the alternate channel. The numeric suffixes <1...8> are irrelevant for this command.

The result can be queried with `CALCulate:LIMit:ACPower:ALternate<1 to 11>:RESult?`. It should be noted that a complete measurement must be performed between switching on the limit check and the result query, since otherwise no valid results are obtained.

Example:

```
"CALC:LIM:ACP:ALT2 30DB, 30DB"
'Sets the relative limit value in screen A for the power in the lower and upper
second alternate adjacent channel to 30 dB below the channel power.

"CALC:LIM:ACP:ALT2:ABS -35DBM, -35DBM"
'Sets the absolute limit value in screen A for the power in the lower and upper
second alternate adjacent channel to -35 dBm.

"CALC:LIM:ACP ON"
'Switches on globally the limit check for the channel/adjacent channel
measurement in screen A.

"CALC:LIM:ACP:ACH:REL:STAT ON"
'Switches on the check of the relative limit values for the alternate adjacent
channels in screen A.

"CALC:LIM:ACP:ACH:ABS:STAT ON"
'Switches on the check of absolute limit values for the alternate adjacent channels
in screen A.

"INIT;*WAI"
'Starts a new measurement and waits for the sweep end.

"CALC:LIM:ACP:ALT:RES?"
'Queries the limit check result in the second alternate adjacent channels in
screen A.
```

Characteristics: *RST value: OFF
SCPI: device-specific

Mode: A

CALCulate<1|2>:LIMit<1...8>:ACPower:ALternate<1 to 11>:ABSolute -200DBM to 200DBM,
-200DBM to 200DBM

This command defines the absolute limit value for the lower/upper alternate adjacent channel power measurement (Adjacent Channel Power) in the selected measurement window.

The numeric suffix after `ALternate<1 to 11>` denotes the alternate channel. The numeric suffixes `<1...8>` are irrelevant for this command.

It should be noted that the absolute limit value for the limit check has no effect as soon as it is below the relative limit value defined with `CALCulate:LIMit:ACPower:ALternate<1 to 11>:RELative`. This mechanism allows automatic checking of the absolute basic values defined in mobile radio standards for the power in adjacent channels.

Parameter: The first value is the limit for the lower and the upper alternate adjacent channel. The second limit value is ignored but must be indicated for reasons of compatibility with the FSE family.

Example:

```
"CALC:LIM:ACP:ALT2:ABS -35DBM, -35DBM"
'Sets the absolute limit value in screen A for the power in the lower and upper
second alternate adjacent channel to -35 dBm.
```

Characteristics: *RST value: -200DBM
SCPI: device-specific

Mode: A

CALCulate<1|2>:LIMit<1...8>:ACPpower:ALTErnate<1 to 11>:ABSolute:STATe ON | OFF

This command activates the limit check for the alternate adjacent channels in the selected measurement window for adjacent channel power measurement (Adjacent Channel Power).

Before the command, the limit check must be globally switched on for the channel/adjacent channel power with the command `CALCulate:LIMit:ACPpower:STATe ON`.

The numeric suffix after `ALTErnate<1 to 11>` denotes the alternate channel. The numeric suffixes `<1...8>` are irrelevant for this command.

The result can be queried with `CALCulate:LIMit:ACPpower:ALTErnate<1 to 11>:RESult?`. It should be noted that a complete measurement must be performed between switching on the limit check and the result query, since otherwise no valid results are available.

Example:

```
"CALC:LIM:ACP:ALT2 30DB, 30DB"
```

'Sets the relative limit value in screen A for the power in the lower and upper second alternate adjacent channel to 30 dB below the channel power.

```
"CALC:LIM:ACP:ALT2:ABS -35DBM, -35DBM"
```

'Sets the absolute limit value in screen A for the power in the lower and upper second alternate adjacent channel to -35 dBm.

```
"CALC:LIM:ACP ON"
```

'Switches on globally the limit check for the channel/adjacent channel measurement in screen A.

```
"CALC:LIM:ACP:ACH:REL:STAT ON"
```

Switches on the check of the relative limit values for the alternative adjacent channels in screen A.

```
"CALC:LIM:ACP:ACH:ABS:STAT ON"
```

'Switches on the check of absolute limit values for the alternative adjacent channels in screen A.

```
"INIT;*WAI"
```

'Starts a new measurement and waits for the sweep end.

```
"CALC:LIM:ACP:ACH:RES?"
```

'Queries the limit check result in the second alternate adjacent channels in screen A.

Characteristics: *RST value: OFF
SCPI: device-specific

Mode: A

CALCulate<1|2>:LIMit<1...8>:ACPpower:ALTErnate<1 to 11>:RESult?

This command queries the result of the limit check for the alternate adjacent channels in the selected measurement window for adjacent channel power measurements.

The numeric suffix after `ALTErnate<1 to 11>` denotes the alternate channel. The numeric suffixes `<1...8>` are irrelevant for this command.

If the power measurement of the adjacent channel is switched off, the command produces a query error.

Parameter: The result is returned in the form `<result>`, `<result>` where `<result>` = PASSED | FAILED and where the first (second) returned value denotes the lower (upper) alternate adjacent channel.

Example: "CALC:LIM:ACP:ALT2 30DB, 30DB"
'Sets the relative limit value in screen A for the power in the lower and upper second alternate adjacent channel to 30 dB below the channel power.

"CALC:LIM:ACP:ALT2:ABS -35DBM, -35DBM"
'Sets the absolute limit value in screen A for the power in the lower and upper second alternate adjacent channel to -35 dBm.

"CALC:LIM:ACP ON"
'Switches on globally the limit check for the channel/adjacent channel measurement in screen A.

"CALC:LIM:ACP:ALT:STAT ON"
'Switches on the limit check for the adjacent channels in screen A.

"INIT;*WAI"
'Starts a new measurement and waits for the sweep end.

"CALC:LIM:ACP:ALT:RES?"
'Queries the limit check result in the second alternate adjacent channels in screen A.

Characteristics: *RST value: --
SCPI: device-specific

Mode: A

This command is a query and therefore has no *RST value.

6.5.3.2 CALCulate:LIMit:CONTrol Subsystem

The CALCulate:LIMit:CONTrol subsystem defines the x-axis (CONTrol-axis).

CALCulate<1|2>:LIMit<1...8>:CONTrol[:DATA] <numeric_value>,<numeric_value>..

This command defines the x-axis values (frequencies or times) of the upper or lower limit lines.

The values are defined independently of the measurement window.

The number of values for the CONTrol axis and for the corresponding UPPer and/or LOWer limit lines have to be identical. Otherwise default values are entered for missing values or not required values are deleted.

In analyzer mode, the unit of values depends on the frequency or time domain of the x-axis, i.e. it is HZ with CALC:LIM:CONT:DOM FREQ and S with CALC:LIM:CONT:DOM TIME.

Example: "CALC:LIM2:CONT 1MHz,30MHz,100MHz, 300MHz,1GHz"
'Defines 5 reference values for the x-axis of limit line 2
"CALC:LIM2:CONT?"
'Outputs the reference values for the x-axis of limit line 2 separated by a comma.

Characteristics: *RST value: - (LIMit:STATe is set to OFF)
SCPI: conform

Mode: R, A

CALCulate<1|2>:LIMit<1...8>:CONTrol:DOMain FREQuency | TIME

This command defines the frequency or time domain for the x-axis values.

Example: "CALC:LIM2:CONT:DOM TIME"
'Defines the time domain for the x-axis of limit line 2.

Characteristics: *RST value: FREQuency
SCPI: device-specific

Mode: R, A

CALCulate<1|2>:LIMit<1...8>:CONTrol:OFFSet <numeric_value>

This command defines an offset for the x-axis value of the selected relative limit line in the frequency or time domain.

The unit of values depends on the frequency or time domain of the x-axis, i.e. it is HZ with CALC:LIM:CONT:DOM FREQ and S with CALC:LIM:CONT:DOM TIME.

Example: "CALC:LIM2:CONT:OFFS 100us"
'Sets the X offset for limit line 2 (defined in the time domain) to 100µs.

Characteristics: *RST value: 0
SCPI: device-specific

Mode: R, A

CALCulate<1|2>:LIMit<1...8>:CONTrol:MODE RELative | ABSolute

This command selects the relative or absolute scaling for the x-axis of the selected limit line. The definition is independent of the measurement window.

Example: "CALC:LIM2:CONT:MODE REL"
'Defines the x-axis of limit line 2 as relatively scaled.

Characteristics: *RST value: ABSolute
SCPI: device-specific

Mode: R, A

CALCulate<1|2>:LIMit<1...8>:CONTrol:SHIFt <numeric_value>

This command moves a limit line by the indicated value in x direction. In contrast to `CALC:LIM:CONT:OFFS`, the line is shifted by modifying the individual x values and not by means of an additive offset. The shift is independent of the measurement window.

In analyzer mode, the unit of values depends on the frequency or time domain of the x-axis, i.e. it is HZ with `CALC:LIM:CONT:DOM FREQ` and S with `CALC:LIM:CONT:DOM TIME`.

In analyzer mode, the unit of values depends on the frequency or time domain of the x-axis, i.e. it is HZ with `CALC:LIM:CONT:DOM FREQ` and S with `CALC:LIM:CONT:DOM TIME`.

Example: "CALC:LIM2:CONT:SHIF 50KHZ"
'Shifts all reference values of limit line 2 by 50 kHz.

Characteristics: *RST value: --
SCPI: device-specific

Mode: R, A

This command is an event and therefore has no *RST value and no query.

CALCulate<1|2>:LIMit<1...8>:CONTrol:SPACing LINear | LOGarithmic

This command selects linear or logarithmic interpolation for the calculation of limit lines from frequency points.

Example: "CALC:LIM:CONT:SPAC LIN"

Characteristics: *RST value: LIN
SCPI: device-specific

Mode: R, A

6.5.3.3 CALCulate:LIMit:LOWer Subsystem

The CALCulate:LIMit:LOWer subsystem defines the lower limit line.

This subsystem is not available in receiver mode.

CALCulate<1|2>:LIMit<1...8>:LOWer[:DATA] <numeric_value>,<numeric_value>...

This command defines the values for the selected lower limit line.

Up to 8 limit lines can be defined at the same time. This command is independent of the measurement window.

The number of values for the CONTrol axis and for the corresponding LOWer limit line has to be identical. Otherwise default values are entered for missing values or not necessary values are deleted.

The unit must be identical with the unit selected by CALC:LIM:UNIT. If no unit is indicated, the unit defined with CALC:LIM:UNIT is automatically used.

If the measured values are smaller than the LOWer limit line, the limit check signals errors.

In analyzer mode, the units DEG, RAD, S, HZ, PCT are not available.

Example: "CALC:LIM2:LOW -30,-40,-10,-40,-30"
'Defines 5 lower limit values for limit line 2 in the preset unit.
"CALC:LIM2:LOW?"
'Outputs the lower limit values of limit line 2 separated by a comma.

Characteristics: *RST value: - (LIMit:STATe is set to OFF)
SCPI: conform

Mode: A

CALCulate<1|2>:LIMit<1...8>:LOWer:STATe ON | OFF

This command switches on or off the indicated limit line. The limit check is activated separately with CALC:LIM:STAT ON.

Up to 8 limit lines can be defined at the same time. The numeric suffixes <1|2> of CALCulate indicate the measurement window.

In analyzer mode, the result of the limit check can be queried with CALCulate:LIMit<1...8>:FAIL?.

Example: "CALC:LIM4:LOW:STAT ON"
'Switches on limit line 4 (lower limit) in screen A.
"CALC2:LIM4:LOW:STAT ON"
'Switches on limit line 4 (lower limit) also in screen B.

Characteristics: *RST value: OFF
SCPI: conform

Mode: A

CALCulate<1|2>:LIMit<1...8>:LOWer:OFFSet <numeric_value>

This command defines an offset for the y-axis of the selected relative lower limit line. In contrast to `CALC:LIM:LOW:SHIFT`, the line is not shifted by modifying the individual Y values but by means of an additive offset. The offset is independent of the measurement window.

Example: `"CALC:LIM2:LOW:OFFS 3dB"`
'Shifts limit line 2 in the corresponding measurement windows by 3 dB upwards.

Characteristics: *RST value: 0
SCPI: device-specific

Mode: A

CALCulate<1|2>:LIMit<1...8>:LOWer:MARGin <numeric_value>

This command defines a margin to a lower limit line, at which out-of-limit values are signaled (if the limit check is active), but not handled as a violation of the limit value. The margin is independent of the measurement window.

Example: `"CALC:LIM:LOW:MARG 10dB"`

Characteristics: *RST value: 0
SCPI: device-specific

Mode: A

CALCulate<1|2>:LIMit<1...8>:LOWer:MODE RELative | ABSolute

This command selects the relative or absolute scaling for the y-axis of the selected lower limit line. The setting is independent of the measurement window.

Selecting RELative causes the unit to be switched to DB.

Example: `"CALC:LIM:LOW:MODE REL"`
'Defines the y-axis of limit line 2 as relative scaled.

Characteristics: *RST value: ABSolute
SCPI: device-specific

Mode: A

CALCulate<1|2>:LIMit<1...8>:LOWer:SHIFt <numeric_value>

This command shifts a limit line by the indicated value in Y direction. In contrast to `CALC:LIM:LOW:OFFS`, the line is shifted by modifying the individual Y values but not by means of an additive offset.

Up to 8 limit lines can be defined at the same time. The shift is independent of the measurement window.

Example: `"CALC:LIM3:LOW:SHIF 20DB"`
'Shifts all Y values of limit line 3 by 20 dB.

Characteristics: *RST value: --
SCPI: device-specific

Mode: A

This command is an event and therefore has no *RST value and no query.

CALCulate<1|2>:LIMit<1...8>:LOWer:SPACing LINear | LOGarithmic

This command selects linear or logarithmic interpolation for the lower limit line.

Example: "CALC:LIM:LOW:SPAC LIN"

Characteristics: *RST value: LIN
SCPI: device-specific

Mode: A

CALCulate<1|2>:LIMit<1...8>:LOWer:THReshold <numeric_value>

This command defines an absolute threshold value for limit lines with relative y-axis scaling independently of the measurement window. The absolute threshold value is used in the limit check as soon as it exceeds the relative limit value.

The unit must correspond to the unit selected with `CALC:LIM:UNIT` (except dB which is not allowed). If no unit is indicated, the unit defined with `CALC:LIM:UNIT` is automatically used (exception: dBm instead of dB).

The units DEG, RAD, S, HZ, PCT are not available.

Example: "CALC:LIM2:LOW:THR -35DBM"
'Defines an absolute threshold value for limit line 2.

Characteristics: *RST value: -200 dBm
SCPI: device-specific

Mode: A

6.5.3.4 CALCulate:LIMit:UPPer Subsystem

The CALCulate:LIMit:UPPer subsystem defines the upper limit line.

CALCulate<1|2>:LIMit<1...8>:UPPer[:DATA] <numeric_value>,<numeric_value>...

This command defines the values for the upper limit lines.

Up to 8 limit lines can be defined at the same time. This command is independent of the measurement window.

The number of values for the CONTrol axis and for the corresponding UPPer and/or LOWEr limit line have to be identical. Otherwise default values are entered for missing values or not necessary values are deleted.

The unit must be identical with the unit selected by CALC:LIM:UNIT. If no unit is indicated, the unit defined with CALC:LIM:UNIT is automatically used.

In analyzer mode, the limit check signals errors if the measured values exceed the UPPer limit line.

Example: "CALC:LIM2:UPP -10,0,0,-10,-5"
'Defines 5 upper limit values for limit line 2 in the preset unit.
"CALC:LIM2:UPP?"
'Outputs the upper limit values for limit line 2 separated by a comma.

Characteristics: *RST value: - (LIMit:STATe is set to OFF)
SCPI: conform

Mode: R, A

CALCulate<1|2>:LIMit<1...8>:UPPer:STATe ON | OFF

This command switches on or off the indicated limit line. The limit check is activated separately with CALC:LIM:STAT ON.

Up to 8 limit lines can be defined at the same time. The numeric suffixes <1|2> of CALCulate indicate the measurement window.

In analyzer mode, the result of the limit check can be queried with CALCulate:LIMit<1 to 8>:FAIL?.

Example: "CALC1:LIM4:UPP:STAT ON"
'Switches on limit line 4 (upper limit) in screen A.
"CALC2:LIM4:UPP:STAT ON"
'Switches on limit line 4 (upper limit) in screen B.

Characteristics: *RST value: OFF
SCPI: conform

Mode: R, A

CALCulate<1|2>:LIMit<1...8>:UPPer:OFFSet <numeric_value>

This command defines an offset for the y-axis of the selected relative upper limit line. In contrast to `CALC:LIM:UPP:SHIFt`, the line is not shifted by modifying the individual Y values but by means of an additive offset. The offset is independent of the measurement window.

Example: `"CALC:LIM2:UPP:OFFS 3dB"`
'Shifts limit line 2 by 3 dB upwards in the corresponding measurement windows.

Characteristics: *RST value: 0
SCPI: device-specific

Mode: R, A

CALCulate<1|2>:LIMit<1...8>:UPPer:MARGin <numeric_value>

This command defines a margin to an upper limit line, at which out-of-limit values are signaled (if the limit check is active), but not handled as a violation of the limit value. The margin is independent of the measurement window.

Example: `"CALC:LIM2:UPP:MARG 10dB"`
'Defines the margin of limit line 2 to 10 dB below the limit value.

Characteristics: *RST value: 0
SCPI: device-specific

Mode: R, A

CALCulate<1|2>:LIMit<1...8>:UPPer:MODE RELative | ABSolute

This command selects the relative or absolute scaling for the y-axis of the selected upper limit line. The setting is independent of the measurement window.

Selecting RELative causes the unit to be switched to DB.

Example: `"CALC:LIM2:UPP:MODE REL"`
'Defines the y-axis of limit line 2 as relative scaled.

Characteristics: *RST value: ABSolute
SCPI: device-specific

Mode: R, A

CALCulate<1|2>:LIMit<1...8>:UPPer:SHIFt <numeric_value>

This command moves a limit line by the indicated value in Y direction. In contrast to `CALC:LIM:UPP:OFFS`, the line is shifted by modifying the individual Y values and not by means of an additive offset.

Up to 8 limit lines can be defined at the same time. The shift is independent of the measurement window.

Example: `"CALC:LIM3:UPP:SHIF 20DB"`
'Shifts all Y values of limit line 3 by 20 dB.

Characteristics: *RST value: --
SCPI: device-specific

Mode: R, A

This command is an event and therefore has no *RST value and no query.

CALCulate<1|2>:LIMit<1...8>:UPPer:SPACing LINear | LOGarithmic

This command selects linear or logarithmic interpolation for the upper limit line.

Example: "CALC:LIM:UPP:SPAC LIN"

Characteristics: *RST value: LIN
SCPI: device-specific

Mode: R, A

CALCulate<1|2>:LIMit<1...8>:UPPer:THReshold <numeric_value>

This command defines an absolute threshold value for limit lines with relative y-axis scaling independently of the measurement window. The absolute threshold value is used in the limit check as soon as it exceeds the relative limit value.

The unit must correspond to the unit selected with `CALC:LIM:UNIT` (except dB which is not possible). If no unit is indicated, the unit defined with `CALC:LIM:UNIT` is automatically used (exception: dBm instead of dB).

In analyzer mode, the units DEG, RAD, S, HZ, PCT are not available.

Example: "CALC:LIM2:UPP:THR -35DBM"
'Defines an absolute threshold value for limit line 2.

Characteristics: *RST value: -200 dBm
SCPI: device-specific

Mode: R, A

6.5.4 CALCulate:MARKer Subsystem

The CALCulate:MARKer subsystem checks the marker functions in the instrument.

The measurement windows are selected via CALCulate1 (screen A) or 2 (screen B).

CALCulate<1|2>:MARKer<1...4>[:STATe] ON | OFF

This command switches on or off the selected marker. If no indication is made, marker 1 is selected automatically. If marker 2, 3 or 4 is selected and used as a delta marker, it is switched to marker mode.

The measurement windows are selected via CALCulate1 (screen A) or 2 (screen B).

Example: "CALC:MARK3 ON"
'Switches marker 3 in screen A on or to marker mode.

Characteristics: *RST value: OFF
SCPI: device-specific

Mode: R, A

CALCulate<1|2>:MARKer<1...4>:AOFF

This command switches off all active markers in the indicated measurement window.

All delta markers and active marker/delta marker measurement functions are also switched off.

Example: "CALC:MARK:AOFF"
'Switches off all markers in screen A.

Characteristics: *RST value: -
SCPI: device-specific

Mode: R, A

This command is an event and therefore has no *RST value and no query.

CALCulate<1|2>:MARKer<1...4>:TRACe 1 to 3

This command assigns the selected marker (1...4) to the indicated measurement curve. The corresponding trace must be active, i.e. its status must be different from "BLANK".

If necessary, the corresponding marker is switched on prior to the assignment.

The measurement windows are selected via CALCulate1 (screen A) or 2 (screen B).

Example: "CALC:MARK3:TRAC 2"
'Assigns marker 3 in screen A to trace 2.
"CALC2:MARK:TRAC 3"
'Assigns marker 1 in screen B to trace 3.

Characteristics: *RST value: -
SCPI: device-specific

Mode: R, A

CALCulate<1|2>:MARKer<1...4>:X 0 to MAX (frequency | sweep time)

This command positions the selected marker to the indicated :

- frequency (span > 0) in receiver and analyzer mode
- time (span = 0) in analyzer mode

- level (APD/CCDF measurement) in analyzer mode

If marker 2, 3 or 4 is selected and used as delta marker, it is switched to marker mode.

The measurement windows are selected via CALCulate1 (screen A) or 2 (screen B).

Example: "CALC1:MARK2:X 10.7MHz"
 'Positions marker 2 in screen A to frequency 10.7 MHz.

Characteristics: *RST value: -
 SCPI: device-specific

Mode: R, A

CALCulate<1|2>:MARKer<1...4>:X:SLIMits[:STATe] ON | OFF

This command switches between a limited (ON) and unlimited (OFF) search range in the selected measurement window. The function is independent of the selection of a marker, i.e. the numeric suffix MARKer<1...4> is irrelevant.

If the time domain power measurement is active, this command limits the evaluation range on the trace.

Example: "CALC:MARK:X:SLIM ON"
 'Switches on search limitation in screen A.

Characteristics: *RST value: OFF
 SCPI: device-specific

Mode: R, A

CALCulate<1|2>:MARKer<1...4>:X:SLIMits:LEFT 0 to MAX (frequency | sweep time)

This command sets the left limit of the search range for markers and delta markers in the selected measurement window. Depending on the x-axis domain, the indicated value defines:

- frequency (span > 0) in receiver and analyzer mode
- time (span = 0) in analyzer mode

The function is independent of the selection of a marker, i.e. the numeric suffix in MARKer<1...4> is irrelevant.

If the time domain power measurement is active, this command limits the evaluation range to the trace.



The function is only available if the search limit for marker and delta marker is switched on (CALC:MARK:X:SLIM ON).

Example: "CALC:MARK:X:SLIM ON"
 'Switches the search limit function on for screen A.

 "CALC:MARK:X:SLIM:LEFT 10MHz"
 'Sets the left limit of the search range in screen A to 10 MHz.

Characteristics: *RST value: - (is set to the left diagram border on switching on search limits)
 SCPI: device-specific

Mode: R, A

CALCulate<1|2>:MARKer<1...4>:X:SLIMits:RIGHT 0 to MAX (frequency | sweep time)

This command sets the right limit of the search range for markers and delta markers in the selected measurement window. Depending on the x-axis domain the indicated value defines a frequency (span > 0) or time (span = 0). The function is independent of the selection of a marker, i.e. the numeric suffix in MARKer<1...4> is irrelevant.

If the time domain power measurement is active, this command limits the evaluation range to the trace.



The function is only available if the search limit for marker and delta marker is switched on (CALC:MARK:X:SLIM ON).

Example:

```
"CALC:MARK:X:SLIM ON"
```

'Switches the search limit function on for screen A.

```
"CALC:MARK:X:SLIM:RIGHT 20MHz"
```

'Sets the right limit of the search range in screen A to 20 MHz.

Characteristics:

*RST value: - (is set to the right diagram border on switching on search limits)
SCPI: device-specific

Mode:

R, A

CALCulate<1|2>:MARKer<1...4>:COUNT ON | OFF

This command switches on or off the frequency counter at the marker position in the selected measurement window. The count result is queried with CALCulate:MARKer:COUNT:FREQUENCY?.

Frequency counting is possible only for one marker at a time for each measurement window. If it is activated for another marker, it is automatically de-activated for the previous marker.

It should be noted that a complete sweep must be performed after switching on the frequency counter to ensure that the frequency to be measured is actually reached. The synchronization to the sweep end required for this is possible only in single-sweep mode.

Example:

```
"INIT:CONT OFF"
```

'Switches to single-sweep mode.

```
"CALC:MARK ON"
```

'Switches on marker 1 in screen A.

```
"CALC:MARK:COUN ON"
```

'Switches on the frequency counter for marker 1.

```
"INIT;*WAI"
```

'Starts a sweep and waits for the end.

```
"CALC:MARK:COUN:FREQ?"
```

'Outputs the measured value in screen A.

Characteristics:

*RST value: OFF
SCPI: device-specific

Mode:

A

CALCulate<1|2>:MARKer<1...4>:COUNT:RESolution 0.1 | 1 | 10 | 100 | 1000 | 10000 Hz

This command specifies the resolution of the frequency counter in the selected measurement window. The setting is independent of the selected marker, i.e. the numeric suffix in MARKer<1...4> is irrelevant.

Example: "CALC:MARK:COUN:RES 1kHz"
'Sets the resolution of the frequency counter to 1 kHz.

Characteristics: *RST value: 1kHz
SCPI: device-specific

Mode: A

CALCulate<1|2>:MARKer<1...4>:COUNT:FREQUENCY?

This command queries the result of the frequency counter for the indicated marker in the selected measurement window. Before the command, the frequency counter should be switched on and a complete measurement performed to obtain a valid count result. Therefore, a single sweep with synchronization must be performed between switching on the frequency counter and querying the count result.

Example: "INIT:CONT OFF"
'Switches to single-sweep mode.

"CALC:MARK2 ON"
'Switches marker 2 in screen A.

"CALC:MARK2:COUN ON"
'Switches the frequency counter for marker 2.

"INIT;*WAI"
'Starts a sweep and waits for the end.

"CALC:MARK2:COUN:FREQ?"
'Outputs the measured value of marker 2 in screen A.

Characteristics: *RST value: -
SCPI: device-specific

Mode: A

This command is only a query and therefore has no *RST value.

CALCulate<1|2>:MARKer<1...4>:COUPlEd[:STATe] ON | OFF

This command switches the coupling of the receiver frequency to the marker on or off.

Example: "CALC:MARK:COUP ON"
'marker coupling is switched on

Characteristics: *RST value: OFF
SCPI: device-specific

Mode: R

The numeric suffix in MARKer<1...4> is irrelevant.

CALCulate<1|2>:MARKer<1...4>:SCOupled[:STATe] ON | OFF

This command switches the coupling of the receiver frequency settings from the corresponding subs cans to the marker frequency on or off.

Example: "CALC:MARK:SCO ON"

Characteristics: *RST value: ON
SCPI: device-specific

Mode: R

The numeric suffix in MARKer<1...4> is not significant.

CALCulate<1|2>:MARKer<1...4>:LOEXclude ON | OFF

This command switches the local oscillator suppression for peak search on or off. This setting is valid for all markers and delta markers in all measurement windows. The numeric suffixes 1|2 and 1...4 are irrelevant.

Example: "CALC:MARK:LOEX ON"

Characteristics: *RST value: ON
SCPI: device-specific

Mode: A-F

CALCulate<1|2>:MARKer<1...4>:Y?

This command queries the measured value of the selected marker in the indicated measurement window. The corresponding marker is activated before or switched to marker mode, if necessary.

To obtain a valid query result, a complete sweep with synchronization to the sweep end must be performed between the activation of the marker and the query of the y value. This is only possible in single-sweep mode.

The query result is output in the unit determined with the [CALCulate<1|2>:UNIT:POWER](#) command. Only with linear level scaling is the output in %.

Example:

```
"INIT:CONT OFF"
'Switches to single-sweep mode.

"CALC:MARK2 ON"
'Switches marker 2 in screen A.

"INIT;*WAI"
'Starts a sweep and waits for the end.

"CALC:MARK2:Y?"
'Outputs the measured value of marker 2 in screen A.
```

Characteristics: *RST value: -
SCPI: device-specific

Mode: A

CALCulate<1|2>:MARKer<1...4>:Y:PERCent 0 to 100%

This command positions the selected marker in the selected window to the given probability. If marker 2, 3 or 4 is selected and used as a delta marker, it is switched to marker mode.



The command is only available with the CCDF measurement switched on.
The associated level value can be determined with the `CALC:MARK:X?` command.

Example: `"CALC1:MARK:Y:PERC 95PCT"`
'Positions marker 1 in screen A to a 'probability of 95%.

Characteristics: *RST value: -
SCPI: device-specific

Mode: A

CALCulate<1|2>:MARKer<1...4>:MAXimum[:PEAK]

This command positions the specified marker to the current maximum value of the corresponding trace. The corresponding marker is activated first or switched to the marker mode.



If no maximum value is found on the trace (level spacing to adjacent values < peak excursion), an execution error (error code: -200) is produced.

Example: `"CALC:MARK2:MAX"`
'Positions marker 2 in screen A to the maximum value of 'the trace.

Characteristics: *RST value: -
SCPI: device-specific

Mode: R, A

This command is an event and therefore has no *RST value and no query.

CALCulate<1|2>:MARKer<1...4>:MAXimum:NEXT

This command positions the specified marker to the next smaller maximum value of the corresponding trace.



If no next smaller maximum value is found on the trace (level spacing to adjacent values < peak excursion), an execution error (error code: -200) is produced.

Example: `"CALC:MARK2:MAX:NEXT"`
'Positions marker 2 in screen A to the next 'lower maximum value.

Characteristics: *RST value: -
SCPI: device-specific

Mode: R, A

This command is an event and therefore has no *RST value and no query.

CALCulate<1|2>:MARKer<1...4>:MAXimum:RIGHT

This command positions the specified marker to the next smaller maximum value to the right of the current value (i.e. in ascending X values) on the corresponding trace.



If no next smaller maximum value is found on the trace (level spacing to adjacent values < peak excursion), an execution error (error code: -200) is produced.

Example:

```
"CALC:MARK2:MAX:RIGHT"
```

'Positions marker 2 in screen A to the next lower maximum value to the right of the current value.

Characteristics:

*RST value: -
SCPI: device-specific

Mode:

R, A

This command is an event and therefore has no *RST value and no query.

CALCulate<1|2>:MARKer<1...4>:MAXimum:LEFT

This command positions the specified marker to the next smaller maximum value to the left of the current value (i.e. in descending X values) on the trace.



If no next smaller maximum value is found on the trace (level spacing to adjacent values < peak excursion), an execution error (error code: -200) is produced.

Example:

```
"CALC:MARK2:MAX:LEFT"
```

'Positions marker 2 in screen A to the next lower maximum value to the left of the current value.

Characteristics:

*RST value: -
SCPI: device-specific

Mode:

R, A

This command is an event and therefore has no *RST value and no query.

CALCulate<1|2>:MARKer<1...4>:MAXimum:AUTO ON | OFF

This command switches an automatic maximum peak search for marker 1 at the end of each particular sweep on and off. The current marker search limit settings (LEFT LIMIT, RIGHT LIMIT, THRESHOLD, EXCLUDE LO) are taken into account. The numeric suffix at MARKer<1...4> is irrelevant.

Example:

```
"CALC:MARK:MAX:AUTO ON"
```

Activates the auto search function for marker 1.

Characteristics:

*RST value: OFF
SCPI: device-specific

Mode:

A

CALCulate<1|2>:MARKer<1...4>:MINimum:AUTO ON | OFF

This command switches an automatic minimum peak search for marker 1 at the end of each particular sweep on and off. The current marker search limit settings (LEFT LIMIT, RIGHT LIMIT, THRESHOLD, EXCLUDE LO) are taken into account. The numeric suffix at MARKer<1...4> is irrelevant.

Example: "CALC:MARK:MIN:AUTO ON"
Activates the auto search function for marker 1.

Characteristics: *RST value: OFF
SCPI: device-specific

Mode: A

CALCulate<1|2>:MARKer<1...4>:MINimum[:PEAK]

This command positions the specified marker to the current minimum value of the corresponding trace. The corresponding marker is activated first or switched to marker mode, if necessary.



If no minimum value is found on the trace (level spacing to adjacent values < peak excursion), an execution error (error code: -200) is produced.

Example: "CALC:MARK2:MIN"
'Positions marker 2 in screen A to the minimum value of the trace.

Characteristics: *RST value: -
SCPI: device-specific

Mode: R, A

This command is an event and therefore has no *RST value and no query.

CALCulate<1|2>:MARKer<1...4>:MINimum:NEXT

This command positions the specified marker to the next higher minimum value of the corresponding trace.



If no next higher minimum value is found on the trace (level spacing to adjacent values < peak excursion), an execution error (error code: -200) is produced.

Example: "CALC:MARK2:MIN:NEXT"
'Positions marker 2 in screen A to the next higher maximum value.

Characteristics: *RST value: -
SCPI: device-specific

Mode: R, A

This command is an event and therefore has no *RST value and no query.

CALCulate<1|2>:MARKer<1...4>:MINimum:RIGHT

This command positions the specified marker to the next higher minimum value to the right of the current value (i.e. in ascending X direction) on the corresponding trace.



If no next higher minimum value is found on the trace (level spacing to adjacent values < peak excursion), an execution error (error code: -200) is produced.

Example:

```
"CALC:MARK2:MIN:RIGHT"
```

'Positions marker 2 in screen A to the next higher minimum value to the right of the current value.

Characteristics:

*RST value: -
SCPI: device-specific

Mode:

R, A

This command is an event and therefore has no *RST value and no query.

CALCulate<1|2>:MARKer<1...4>:MINimum:LEFT

This command positions the specified marker to the next higher minimum value to the left of the current value (i.e. in descending X direction) on the corresponding trace.



If no next higher minimum value is found on the trace (level spacing to adjacent values < peak excursion), an execution error (error code: -200) is produced.

Example:

```
"CALC:MARK2:MIN:LEFT"
```

'Positions marker 2 in screen A to the next higher minimum value to the left of the current value.

Characteristics:

*RST value: -
SCPI: device-specific

Mode:

R, A

This command is an event and therefore has no *RST value and no query.

CALCulate<1|2>:MARKer<1...4>:PEXCursion <numeric_value>

This command defines the peak excursion, i.e. the spacing below a trace maximum which must be attained before a new maximum is recognized, or the spacing above a trace minimum which must be attained before a new minimum is recognized. The set value is valid for all markers and delta markers. The unit depends on the selected operating mode.

Example:

```
"CALC:MARK:PEXC 10dB"
```

'Defines peak excursion 10 dB.

Characteristics:

*RST value: 6dB
SCPI: device-specific

Mode:

R, A

The numeric suffix in MARKer<1...4> is irrelevant.

6.5.4.1 CALCulate:MARKer:FUNction Subsystem

The measurement window is selected by CALCulate 1 (screen A) or 2 (screen B).

CALCulate<1|2>:MARKer<1...4>:FUNction:FPEaks[:IMMediate] <numeric_value>

This command searches the selected trace for the indicated number of maxima. The results are entered in a list and can be queried with commands `CALC:MARK:FUNC:FPEaks:X?` and `CALC:MARK:FUNC:FPEaks:Y?`. The number of maxima found can be queried with `CALC:MARK:FUNC:FPEaks:COUNT?`. The trace to be examined is selected with `CALC:MARK:TRACe`. The order of the results in the list can be defined with `CALC:MARK:FUNC:FPEaks:SORT`.



The number of maxima found depends on the waveform and value set for the Peak Excursion parameter (`CALC:MARK:PEXC`), however, a maximum number of 50 maxima are determined. Only the signals which exceed their surrounding values at least by the value indicated by the peak excursion parameter will be recognized as maxima. Therefore, the number of maxima found is not automatically the same as the number of maxima desired.

Example:

```
"INIT:CONT OFF"
'switches to single-sweep mode

"INIT;*WAI"
'starts measurement and synchronizes to end

"CALC:MARK:TRAC 1"
'sets marker 1 in screen A to trace 1

"CALC:MARK:FUNC:FPE:SORT X"
'sets the sort mode to increasing X values

"CALC:MARK:FUNC:FPE 3"
'searches the 3 highest maxima for trace 1

"CALC:MARK:FUNC:COUN?"
'queries the number of maxima found

"CALC:MARK:FUNC:Y?"
'queries the level of maxima found

"CALC:MARK:FUNC:X?"
'queries the frequencies (span <> 0) or time (span = 0) of maxima found.
```

Characteristics: *RST value: --
SCPI: device-specific

Mode: A

CALCulate<1|2>:MARKer<1...4>:FUNction:FPEaks:COUNT?

This query reads out the number of maxima found during the search. If no search for maxima has been performed, 0 is returned.

Example:

```
"CALC:MARK:FUNC:FPE 3"
'searches the 3 highest maxima for trace 1

"CALC:MARK:FUNC:FPE:COUN?"
'queries the number of maxima found
```

Characteristics: *RST value: --
SCPI: device-specific

Mode: A

CALCulate<1|2>:MARKer<1...4>:FUNCtion:FPEaks:X?

This query reads out the list of X values of the maxima found. The number of available values can be queried with `CALC:MARK:FUNC:FPEaks:COUNt?`.

With sort mode X, the X values are in increasing order; with sort mode Y the order corresponds to the decreasing order of the Y values.

Example:

```
"CALC:MARK:FUNC:FPE:SORT Y"
'sets the sort mode to decreasing y values

"CALC:MARK:FUNC:FPE 3"
'searches the 3 highest maxima for trace 1

"CALC:MARK:FUNC:FPE:COUN?"
'queries the number of maxima found

"CALC:MARK:FPE:FUNC:X?"
'queries the frequencies (span <> 0) or time (span = 0) of the maxima found.
```

Return value:

```
"107.5E6,153.8E6,187.9E6"
'frequencies in increasing order

"2.05E-3,2.37E-3, 3.71e-3"
'times in increasing order
```

Characteristics: *RST value: --
SCPI: device-specific

Mode: A

CALCulate<1|2>:MARKer<1...4>:FUNCtion:FPEaks:Y?

This query reads out the list of X values of the maxima found. The number of available values can be queried with `CALC:MARK:FUNC:FPEaks:COUNt?`.

With sort mode X, the X values are in increasing order; with sort mode Y the order corresponds to the decreasing order of the Y values.

Example:

```
"CALC:MARK:FUNC:FPE:SORT Y"
'sets the sort mode to decreasing y values

"CALC:MARK:FUNC:FPE 3"
'searches the 3 highest maxima for trace 1

"CALC:MARK:FUNC:FPE:COUN?"
'queries the number of maxima found

"CALC:MARK:FUNC:FPE:Y?"
'queries the levels of the maxima found.
```

Return value:

```
"-37.5,-58.3,-59.6"
'level in decreasing order
```

Characteristics: *RST value: --
SCPI: device-specific

Mode: A

CALCulate<1|2>:MARKer<1...4>:FUNCTION:FPEaks:SORT X | Y

This command sets the sort mode for the search for maxima:

Parameter: X: the maxima are sorted in the list of responses according to increasing X values
Y: the maxima are sorted in the list of responses according to decreasing Y values

Example: "CALC:MARK:FUNC:FPE:SORT Y"
'sets the sort mode to decreasing y values

Characteristics: *RST value: --
SCPI: device-specific

Mode: A

CALCulate<1|2>:MARKer<1...4>:FUNCTION:NDBDown <numeric_value>

This command defines the level spacing of the two delta markers to the right and left of marker 1 in the selected measurement window. Marker 1 is always used as the reference marker. The numeric suffix <1...4> is irrelevant for this command.

The temporary markers T1 and T2 are positioned by n dB below the active reference marker. The frequency spacing of these markers can be queried with CALCulate:MARKer:FUNCTION:NDBDown:RESult?.

If a negative value is entered than the markers are placed n dB above the active reference marker. This is then a n dB up function which can be used for notch filter measurements:

Example: "CALC:MARK:FUNC:NDBD 3dB"
'Sets the level spacing in screen A to 3 dB.

Characteristics: *RST value: 6dB
SCPI: device-specific

Mode: A

CALCulate<1|2>:MARKer<1...4>:FUNCTION:NDBDown:STATe ON | OFF

This command switches the "N dB Down" function on or off in the selected measurement window. Marker 1 is activated first, if necessary. The numeric suffix <1...4> is irrelevant for this command.

Example: "CALC:MARK:FUNC:NDBD:STAT ON"
'Switches on the N-dB-down function in screen A.

Characteristics: *RST value: OFF
SCPI: device-specific

Mode: A

CALCulate<1|2>:MARKer<1...4>:FUNCTION:NDBDown:RESult?

This command queries the frequency spacing (bandwidth) of the N-dB-down markers in the selected measurement window. The numeric suffix <1...4> is irrelevant for this command.

A complete sweep with synchronization to sweep end must be performed between switching on the function and querying the measured value in order to obtain a valid query result. This is only possible in single-sweep mode.

Example:

```
"INIT:CONT OFF"
'Switches to single-sweep mode.

"CALC:MARK:FUNC:NDBD ON"
'Switches on the n-dB-down function in screen A.

"INIT;*WAI"
'Starts a sweep and waits for the end.

"CALC:MARK:FUNC:NDBD:RES?"
'Outputs the measured value of screen A.
```

Characteristics: *RST value: -
SCPI: device-specific

Mode: A

This command is only a query and therefore has no *RST value.

CALCulate<1|2>:MARKer<1...4>:FUNCTION:NDBDown:FREQUENCY?

This command queries the two frequencies of the N-dB-down marker in the selected measurement window. The numeric suffix <1...4> is irrelevant for this command. The two frequency values are separated by comma and output in ascending order.

A complete sweep with synchronization to sweep end must be performed between switching on the function and querying the measured value to obtain a valid query result. This is only possible in single-sweep mode.

Example:

```
"INIT:CONT OFF"
'Switches to single-sweep mode.

"CALC:MARK:FUNC:NDBD ON"
'Switches on the n-dB-down function in screen A.

"INIT;*WAI"
'Starts a sweep and waits for the end.

"CALC:MARK:FUNC:NDBD:FREQ?"
'Outputs the frequencies of the temporary markers in screen A.
```

Characteristics: *RST value: -
SCPI: device-specific

Mode: A

This command is only a query and therefore has no *RST value.

CALCulate<1|2>:MARKer<1...4>:FUNCTION:NDBDown:TIME?

This command queries the two time values of the "N dB Down" markers in the specified measurement window. The suffix <1...4> has no meaning with this command. The two time values are output in ascending order, separated by commas.

To obtain a valid query response, a complete sweep with synchronization to the sweep end must have been performed in between activating the function and querying the measurement results. This is possible only in single-sweep mode.

Example: "INIT:CONT OFF"
'Switches to single-sweep mode.

"CALC:MARK:FUNC:NDBD ON"
'Switches on the "N dB Down" function in screen A.

"INIT;*WAI"
'Starts a sweep and waits for the end.

"CALC:MARK:FUNC:NDBD:TIME?"
'Outputs the time values of the temporary markers in screen A.

Characteristics: *RST value: -
SCPI: device-specific

Mode: A-T

This command is a query only and thus has no *RST value

CALCulate<1|2>:MARKer<1...4>:FUNCTION:ZOOM <numeric_value>

The frequency at the marker position becomes the new center frequency at the diagram. The results of a previous measured scan are displayed in the activated frequency range.

Example: "INIT:CONT OFF"
'Switches to single-sweep mode

"CALC:MARK:FUNC:ZOOM 1kHz;*WAI"
'Activates zooming in screen A and waits for its end.

for phase noise mode
"CALC1:MARK1:FUNC:ZOOM 10"
'Zooms in around marker 1 by a factor of 10.

Characteristics: *RST value: -
SCPI: device-specific

Mode: R, A

This command is an event and therefore has no *RST value and no query.

CALCulate<1|2>:MARKer<1...4>:FUNCTION:NOISe[:STATe] ON | OFF

This command switches the noise measurement on or off for all markers of the indicated measurement window. The noise power density is measured at the position of the markers. The result can be queried with `CALCulate:MARKer:FUNCTION:NOISe:RESult?`.

Example: "CALC2:MARK:FUNC:NOIS ON"
'Switches on the noise measurement for screen B.

Characteristics: *RST value: OFF
SCPI: device-specific

Mode: A

CALCulate<1|2>:MARKer<1...4>:FUNction:NOISe:RESult?

This command queries the result of the noise measurement.

A complete sweep with synchronization to the sweep end must be performed between switching on the function and querying the measured value in order to obtain a valid query result. This is only possible in single-sweep mode.

Example:

```
"INIT:CONT OFF"
'Switches to single-sweep mode.

"CALC:MARK2 ON"
'Switches on marker 2 in screen A.

"CALC:MARK2:FUNC:NOIS ON"
'Switches on noise measurement for marker 2.

"INIT;*WAI"
'Starts a sweep and waits for the end.

"CALC:MARK2:FUNC:NOIS:RES?"
'Outputs the noise result of marker 2 in screen A.
```

Characteristics: *RST value: -
SCPI: device-specific

Mode: A

This command is an event and therefore has no *RST value and no query.

CALCulate<1|2>:MARKer<1...4>:FUNction:DEModulation:SElect AM | FM

This command selects the demodulation type for the audio demodulator. The command is independent of the measurement window and of the selected marker, i.e. suffixes 1|2 and 1...4 are irrelevant.



In receiver mode the audio demodulator is controlled by the `SENSe:DEMod` subsystem.

Example: "CALC:MARK:FUNC:DEM:SEL FM"

Characteristics: *RST value: AM
SCPI: device-specific

Mode: A

CALCulate<1|2>:MARKer<1...4>:FUNction:DEModulation[:STATe] ON | OFF

This command switches on or off the audio demodulator when the indicated marker is reached in the selected measurement window. In the frequency domain (span > 0) the hold time can be defined at the corresponding marker position with `CALCulate:MARKer:FUNction:DEModulation:HOLD`. In the time domain (span = 0) the demodulation is permanently active.

Example:

```
"CALC2:MARK3:FUNC:DEM ON"
'Switches on the demodulation for marker 3 in screen B.
```

Characteristics: *RST value: OFF
SCPI: device-specific

Mode: A

CALCulate<1|2>:MARKer<1...4>:FUNCtion:DEModulation:HOLDoff 10ms to 1000s

This command defines the hold time at the marker position for the demodulation in the frequency domain (span > 0). The setting is independent of the measurement window and the selected marker, i.e. the suffixes <1|2> and <1...4> are irrelevant

Example: "CALC:MARK:FUNC:DEM:HOLD 3s"

Characteristics: *RST value: - (DEModulation is set to OFF)
SCPI: device-specific

Mode: A

CALCulate<1|2>:MARKer<1...4>:FUNCtion:DEModulation:CONTinuous ON | OFF

This command switches on or off the continuous demodulation in the frequency domain (span > 0) in the selected measurement window. Thus acoustic monitoring of the signals can be performed in the frequency domain. The function does not depend on the selected marker, i.e. the numeric suffix <1...4> is irrelevant.

Example: "CALC2:MARK3:FUNC:DEM:CONT ON"
'Switches on the continuous demodulation in screen B.

Characteristics: *RST value: OFF
SCPI: device-specific

Mode: A

CALCulate<1|2>:MARKer<1...4>:FUNCtion:DEModulation:SQUelch[:STATe] ON | OFF

This command enables or disables the squelch function for the audio output.

This function is linked to the video trigger. Therefore Gated Trigger is not available.

Example: "CALC:MARK:FUNC:DEM:SQU ON"

Characteristics: *RST value: OFF

Mode: A

CALCulate<1|2>:MARKer<1...4>:FUNCtion:DEModulation:SQUelch:LEVel 0 to 100 PCT

This command sets the trigger level for the squelch function.

Example: "CALC:MARK:FUNC:DEM:SQU ON"
'Switches on the squelch function.

"CALC:MARK:FUNC:DEM:SQU:LEV 80 PCT"
'Sets the squelch to 80%.

Characteristics: *RST value: 50PCT
SCPI: device-specific

Mode: A

CALCulate<1|2>:MARKer<1...4>:FUNCtion:MDEPth[:STATe]

This command switches on the measurement of the AM modulation depth. An AM-modulated carrier is required on the screen for correct operation. If necessary, marker 1 is previously activated and set to the largest signal available.

The level value of marker 1 is regarded as the carrier level. On activating the function, marker 2 and marker 3 are automatically set as delta markers symmetrically to the carrier to the adjacent maxima of the trace.

If the position of delta marker 2 is changed, delta marker 3 is moved symmetrically with respect to the reference marker (marker 1). If the position of delta marker 3 is changed, fine adjustment can be performed independently of delta marker 2.

The R&S ESCI calculates the power at the marker positions from the measured levels.

The AM modulation depth is calculated from the ratio of power values at the reference marker and the delta markers. If the two AM sidebands differ in power, the average value of the two power values is used for calculating the AM modulation depth.

The numeric suffix <1...4> of :MARKer is irrelevant with this command.

Example:

```
"CALC:MARK:X 10MHZ"
'Sets the reference marker (marker 1) to the carrier signal at 10 MHz

"CALC:MARK:FUNC:MDEP ON"
'Switches on the modulation depth measurement in screen A.

"CALC:DELT2:X 10KHZ"
'Sets delta markers 2 and 3 to the signals at 10 kHz from the carrier signal

"CALC:DELT3:X 9.999KHZ"
'Corrects the position of delta marker 3 relative to delta marker 2.
```

Characteristics: *RST value: OFF
SCPI: device-specific

Mode: A

CALCulate<1|2>:MARKer<1...4>:FUNCtion:MDEPth:RESult?

This command queries the AM modulation depth in the indicated measurement window.

A complete sweep with synchronization to sweep end must be performed between switching on the function and querying the measured value to obtain a valid query result. This is only possible in single-sweep mode.

The numeric suffix <1...4> of :MARKer is irrelevant for this command.

Example:

```
"INIT:CONT OFF"
'Switches to single-sweep mode.

"CALC:MARK:X 10MHZ"
'Sets the reference marker (marker 1) to the carrier signal at 10 MHz.

"CALC:MARK:FUNC:MDEP ON"
'Switches on the modulation depth measurement in screen A.

"INIT;*WAI"
'Starts a sweep and waits for the end.

"CALC:MARK:FUNC:MDEP:RES?"
'Outputs the measured value of screen A.
```

Characteristics: *RST value: -
SCPI: device-specific

Mode: A

This command is only a query and therefore has no *RST value.

CALCulate<1|2>:MARKer<1...4>:FUNCtion:TOI[:STATe] ON | OFF

This command initiates the measurement of the third-order intercept point.

A two-tone signal with equal carrier levels is expected at the RF input of the instrument. Marker 1 and marker 2 (both normal markers) are set to the maximum of the two signals. Delta marker 3 and delta marker 4 are positioned to the intermodulation products. The delta markers can be modified separately afterwards with the commands `CALCulate:DELTamarker3:X` and `CALCulate:DELTamarker4:X`.

The third-order intercept is calculated from the level spacing between the normal markers and the delta markers.

The numeric suffix <1...4> of :MARKer is irrelevant for this command.

Example: `"CALC:MARK:FUNC:TOI ON"`
 'Switches on the measurement of the third-order intercept in screen A.

Characteristics: *RST value: OFF
 SCPI: device-specific

Mode: A

CALCulate<1|2>:MARKer<1 to 4>:FUNCtion:TOI:MARKer CALCulate | SEARch

This command controls the positioning of the intercept markers 3 and 4 for TOI measurement, based on the two carrier signals.

- `CALCulate:`
 Calculates the intermodulation product frequencies.
- `SEARch:`
 Performs a local peak search near the expected intermodulation product frequencies.

Example: `"CALC:MARK:FUNC:TOI:MARK SEAR"`
 ' selects TOI marker search mode

Characteristics: *RST value: CALC
 SCPI: device-specific

Mode: A

CALCulate<1|2>:MARKer<1...4>:FUNCtion:TOI:RESult?

This command queries the third-order intercept point measurement in the indicated measurement window.

A complete sweep with synchronization to sweep end must be performed between switching on the function and querying the measured value to obtain a valid query result. This is only possible in single-sweep mode.

The numeric suffix <1...4> of :MARKer is irrelevant of this command.

Example: `"INIT:CONT OFF"`
 'Switches to single-sweep mode.

`"CALC:MARK:FUNC:TOI ON"`
 'Switches the intercept measurement in screen A.

`"INIT;*WAI"`
 'Starts a sweep and waits for the end.

`"CALC:MARK:FUNC:TOI:RES?"`
 'Outputs the measured value of screen A.

Characteristics: *RST value: -
SCPI: device-specific

Mode: A

This command is only a query and therefore has no *RST value.

CALCulate<1|2>:MARKer<1...4>:FUNCtion:CENTer

This command sets the receiver or center frequency of the selected measurement window equal to the frequency of the indicated marker.

If marker 2, 3 or 4 is selected and used as delta marker, it is switched to the marker mode.

Example: "CALC:MARK2:FUNC:CENT"
'Sets the receiver frequency to the frequency of marker 2.

Characteristics: *RST value: -
SCPI: device-specific

Mode: R, A-F

This command is an "event" and therefore has no *RST value and no query.

CALCulate<1|2>:MARKer<1...4>:FUNCtion:CSTep

This command sets the step width of the receiver or center frequency in the selected measurement window to the X value of the current marker.

If marker 2, 3 or 4 is selected and used as delta marker, it is switched to the marker mode.

Example: "CALC2:MARK2:FUNC:CST"
'Sets the receiver frequency to the same value as the frequency of marker 2.

Characteristics: *RST value: -
SCPI: device-specific

Mode: R, A-F

This command is an event and therefore has no *RST value and no query.

CALCulate<1|2>:MARKer<1...4>:FUNCtion:REFerence

This command sets the reference level to the power measured by the indicated marker. If the selected marker was used as delta marker, it is switched to marker mode.

Example: "CALC:MARK2:FUNC:REF"
'Sets the reference level of screen A to the level of marker 2.

Characteristics: *RST value: -
SCPI: device-specific

Mode: A

This command is an event and therefore has no *RST value and no query.

6.5.4.2 CALCulate:MARKer:FUNCtion:HARMonics Subsystem

The CALCulate:MARKer:FUNCtion:HARMonics subsystem contains the commands for Harmonic Distortion measurement

CALCulate<1|2>:MARKer<1...4>:FUNCtion:HARMonics[:STATE] ON | OFF

This command switches on or off the measurement of the harmonics of a carrier signal. The carrier signal is the first harmonic. The function is independent of the marker selection, i.e. the suffix <1|2> or <1...4> of CALCulate or MARKer is irrelevant. It is only available in the frequency domain (span > 0).

If the measurement is started in the frequency domain (span > 0), the last span will define the search range for the first harmonic. The level for the first harmonic will also be calculated in the frequency domain. However, the measurement can also be started in the time domain (span = 0), in which case the center frequency and the level used will remain unchanged.

Example: "CALC:MARK:FUNC:HARM ON"
'Switches on the measurement of harmonics.

Characteristics: *RST value: OFF
SCPI: device-specific

Mode: A-F^

CALCulate<1|2>:MARKer<1...4>:FUNCtion:HARMonics:BANDwidth[:LIST]?

This command returns the resolution bandwidth values used by the harmonic measurement. A separate value for every harmonic frequency is automatically calculated. It is possible to query the calculated values with this command.

The function is independent of the marker selection, i.e. the suffix <1|2> or <1 to 4> of CALCulate or MARKer is irrelevant.

Example: "CALC:MARK:FUNC:HARM:BAND?"
'Returns the used bandwidth values of the harmonics measurement.

Characteristics: *RST value:-
SCPI: device-specific

This command is an event and therefore has no *RST value and no query.

CALCulate<1|2>:MARKer<1...4>:FUNCtion:HARMonics:NHARmonics 1 to 26

This command defines the number of harmonics of a carrier signal to be measured. The function is independent of the marker selection, i.e. the suffix <1|2> or <1...4> of CALCulate or MARKer is irrelevant.

Example: "CALC:MARK:FUNC:HARM:NHARM 3"
'Sets the number of harmonics to be measured to 3.

Characteristics: *RST value: OFF
SCPI: device-specific

Mode: A-F

CALCulate<1|2>:MARKer<1...4>:FUNCtion:HARMonics:BANDwidth:AUTO ON | OFF

This command specifies whether the resolution bandwidth of the 2nd to the nth harmonic should be identical to the bandwidth of the first harmonic (OFF) or to the next largest bandwidth (corresponding to the harmonic) of the multiple of the bandwidth of the first harmonic (ON).

Example: "CALC:MARK:FUNC:HARM:BAND:AUTO OFF"
'Switches automatic bandwidth expansion off.

Characteristics: *RST value: ON
SCPI: device-specific

Mode: A-F, A-T

CALCulate<1|2>:MARKer<1...4>:FUNCTION:HARMonics:PRESet

This command optimizes the device settings depending on the mode in which the harmonic measurement was started:

If the harmonic measurement was started in the frequency domain (span > 0), the frequency and the level of the first harmonic are calculated, from which the measurement list is set up.

If the measurement was started in the time domain (span = 0), the frequency of the first harmonic is not changed. The level, however, is not calculated.

The function is independent of the marker selection, i.e. the suffix <1|2> or <1...4> of CALCulate or MARKer is irrelevant.

Example: "CALC:MARK:FUNC:HARM:PRES"
'Optimizes the device setting for the measurement of harmonics.

Characteristics: *RST value: --
SCPI: device-specific

This command is an event and therefore has no *RST value and no query.

Mode: A-F, A-T

CALCulate<1|2>:MARKer<1...4>:FUNCTION:HARMonics:DISToRTion? TOTal

This command queries the results of the total harmonic distortion (THD).

A complete sweep with synchronization to sweep end should be performed between switching on the function and querying the measured value to obtain a valid query result. This is only possible in the single-sweep mode.

The function is independent of the marker selection, i.e. the suffix <1|2> or <1...4> of CALCulate or MARKer is irrelevant.

Example: "INIT:CONT OFF"
'Switches to single-sweep mode.

"CALC:MARK:FUNC:HARM:NHARM 3"
'Sets the number of harmonics to 3.

"CALC:MARK:FUNC:HARM ON"
'Switches on the measurement of harmonics.

"INIT;*WAI"
'Starts a sweep and waits for the end.

"CALC:MARK:FUNC:HARM:DIS? TOT"
'Outputs the total harmonic distortion in % and dB.

Characteristics: *RST value: --
SCPI: device-specific

Mode: A-F, A-T

CALCulate<1|2>:MARKer<1...4>:FUNCtion:HARMonics:LIST?

This command reads out the list of harmonics. The first value is the absolute power of the first harmonic in the unit set via UNIT. The other values are relative to the carrier signal and are output in dB.

The numeric values are output, separated by commas. The number corresponds to that of the harmonics to be measured, which are defined with `CALC:MARK:FUNC:HARM:NHARM`.

A complete sweep with synchronization to sweep end should be performed between switching on the function and querying the measured value to obtain a valid query result. This is only possible in the single-sweep mode.

The function is independent of the marker selection, i.e. the suffix `<1|2>` or `<1...4>` of `CALCulate` or `MARKer` is irrelevant.

Example:

```
"INIT:CONT OFF"
'Switches to single-sweep mode.

"CALC:MARK:FUNC:HARM:NHARM 3"
'Sets the number of harmonics to 3.

"CALC:MARK:FUNC:HARM ON"
'Switches on the measurement of harmonics.

"INIT;*WAI"
'Starts a sweep and waits for the end.

"CALC:MARK:FUNC:HARM:LIST?"
'Outputs the three measured harmonics, separated by commas.
```

Characteristics: *RST value: --
SCPI: device-specific

Mode: A-F, A-T

6.5.4.3 CALCulate:MARKer:FUNCtion:POWER Subsystem

The CALCulate:MARKer:FUNCtion:POWER subsystem contains the commands for control of power measurement.

CALCulate<1|2>:MARKer<1...4>:FUNCtion:POWER:SElect ACPower | CPOWer | MCACpower | OBANdwidth | OBWidth | CN | CN0

This command selects – and switches on – one of the above types of power measurement in the selected measurement window. This function is independent of the selected marker, i.e. the numerical suffix <1...4> appended to MARKer has no effect.

The channel spacings and channel bandwidths are configured in the SENSE:POWer:ACHannel subsystem.

Please note the following:

If CPOWer is selected, the number of adjacent channels (command: [SENSE:]POWer:ACHannel:ACPairs) is set to 0. If ACPower is selected, the number of adjacent channels is set to 1, unless adjacent channel power measurement is switched on already.

With respect to the above two settings, the behavior of the R&S ESCI differs from that of the ESIB family.

This command is a query and therefore has no *RST value.



The channel/adjacent channel power measurement is performed for the trace selected with SENSE:POWer:TRACe 1|2|3.

The occupied bandwidth measurement is performed for the trace on which marker 1 is positioned. To select another trace for the measurement, marker 1 is to be positioned on the desired trace by means of CALC:MARK:TRAC 1|2|3.

Parameter:

- ACPower: adjacent channel power measurement with a single carrier signal
- CPOWer: Channel power measurement with a single carrier signal (equivalent to adjacent channel power measurement with *NO. OF ADJ CHAN = 0*)
- MCACpower: Channel/adjacent channel power measurement with several carrier signals
- OBANdwidth | OBWidth: Measurement of occupied bandwidth
- CN: Measurement of carrier-to-noise ratio
- CN0: Measurement of carrier-to-noise ratio referenced to 1 Hz bandwidth

Example: "CALC:MARK:FUNC:POW:SEL ACP"
'Switches on adjacent channel power measurement in window A.

Characteristics: *RST value: -
SCPI: device-specific

Mode: A-F

CALCulate<1|2>:MARKer<1...4>:FUNction:POWer:RESult? ACPower | CPOWer | MCACpower | OBANdwidth | OBWidth | CN | CN0

This command queries the result of the power measurement performed in the selected window. If necessary, the measurement is switched on prior to the query.

The channel spacings and channel bandwidths are configured in the `SENSe:POWer:ACHannel` subsystem.

To obtain a valid result, a complete sweep with synchronization to the end of the sweep must be performed before a query is output. Synchronization is possible only in the single-sweep mode.

Parameters:

ACPower: adjacent channel power measurement

Results are output in the following sequence, separated by commas:

1. Power of transmission channel
2. Power of lower adjacent channel
3. Power of upper adjacent channel
4. Power of lower alternate channel 1
5. Power of upper alternate channel 1
6. Power of lower alternate channel 2
7. Power of upper alternate channel 2

The number of measured values returned depends on the number of adjacent/alternate channels selected with `SENSe:POWer:ACHannel:ACPairs`.

With logarithmic scaling (RANGE LOG), the power is output in the currently selected level unit; with linear scaling (RANGE LIN dB or LIN %), the power is output in W. If `SENSe:POWer:ACHannel:MODE REL` is selected, the adjacent/alternate-channel power is output in dB.

CPOWer: Channel power measurement

With logarithmic scaling (RANGE LOG), the channel power is output in the currently selected level unit; with linear scaling (RANGE LIN dB or LIN %), the channel power is output in W.

MCACpower: Channel/adjacent channel power measurement with several carrier signals

Results are output in the following sequence, separated by commas:

1. Power of carrier signal 1
2. Power of carrier signal 2
3. Power of carrier signal 3
4. Power of carrier signal 4
5. Power of carrier signal 5
6. Power of carrier signal 6
7. Power of carrier signal 7
8. Power of carrier signal 8
9. Power of carrier signal 9
10. Power of carrier signal 10
11. Power of carrier signal 11
12. Power of carrier signal 12

- 13.Total power of all carrier signals
- 14.Power of lower adjacent channel
- 15.Power of upper adjacent channel
- 16.Power of lower alternate channel 1
- 17.Power of upper alternate channel 1
- 18.Power of lower alternate channel 2
- 19.Power of upper alternate channel 2

The number of measured values returned depends on the number of carrier signals and adjacent/alternate channels selected with

`SENSe:POWer:ACHannel:TXChannel:COUNT` and `SENSe:POWer:ACHannel:ACPairs`.

If only one carrier signal is measured, the total value of all carrier signals will not be output.

With logarithmic scaling (`RANGE LOG`), the power is output in dBm; with linear scaling (`RANGE LIN dB` or `LIN %`), the power is output in W. If `SENSe:POWer:ACHannel:MODE REL` is selected, the adjacent/alternate-channel power is output in dB.

OBANdwidth |
OBWidth:

Measurement of occupied bandwidth

The occupied bandwidth in Hz is returned.

CN:

Measurement of carrier-to-noise ratio

The carrier-to-noise ratio in dB is returned.

CNO:

Measurement of carrier-to-noise ratio referenced to 1 Hz bandwidth.

The carrier-to-noise ratio in dB/Hz is returned.

Example of channel/adjacent channel power measurement:

<code>"SENS2:POW:ACH:ACP 3"</code>	'Sets the number of adjacent/alternate channels in screen B to 3.
<code>"SENS2:POW:ACH:BAND 30KHZ"</code>	'Sets the bandwidth of the transmission channel to 30 kHz.
<code>"SENS2:POW:ACH:BAND:ACH 40KHZ"</code>	'Sets the bandwidth of each adjacent channel to 40 kHz.
<code>"SENS2:POW:ACH:BAND:ALT1 50KHZ"</code>	'Sets the bandwidth of each alternate channel to 50 kHz.
<code>"SENS2:POW:ACH:BAND:ALT2 60KHZ"</code>	'Sets the bandwidth of alternate channel 2 to 60 kHz.
<code>"SENS2:POW:ACH:SPAC 30KHZ"</code>	'Sets the spacing between the transmission channel and the adjacent channel to 30 kHz, the spacing between the transmission channel and alternate channel 1 to 60 kHz, and the spacing between the transmission channel and alternate channel 2 to 90 kHz.
<code>"SENS2:POW:ACH:SPAC:ALT1 100KHZ"</code>	'Sets the spacing between the transmission channel and alternate channel 1 to 100 kHz, and the spacing between the transmission channel and alternate channel 2 to 150 kHz.
<code>"SENS2:POW:ACH:SPAC:ALT2 140KHZ"</code>	'Sets the spacing between the transmission channel and alternate channel 2 to 140 kHz.
<code>"SENS2:POW:ACH:MODE ABS"</code>	'Switches on absolute power measurement.

"CALC2:MARK:FUNC:POW:SEL ACP"	'Switches on the adjacent channel power measurement in screen B.
"INIT:CONT OFF"	'Switches over to single-sweep mode.
"INIT;*WAI"	'Starts a sweep and waits for the end of the sweep.
"CALC2:MARK:FUNC:POW:RES? ACP"	'Queries the result of adjacent channel power measurement in screen B.
"SENS2:POW:ACH:REF:AUTO ONCE"	'Defines the measured channel power as the reference value for relative power measurements.

If the **channel power only** is to be measured, all commands relating to adjacent/alternate channel bandwidth and channel spacings are omitted. The number of adjacent/alternate channels is set to 0 with `SENS2:POW:ACH:ACP 0`.

Example of occupied bandwidth measurement:

"SENS2:POW:BAND 90PCT"	'Defines 90% as the percentage of the power to be contained in the bandwidth range to be measured.
"INIT:CONT OFF"	'Switches over to single-sweep mode.
"INIT;*WAI"	'Starts a sweep and waits for the end of the sweep.
"CALC2:MARK:FUNC:POW:RES? OBW"	'Queries the occupied bandwidth measured in screen B.

Characteristics: *RST value: -
SCPI: device-specific

Mode: A-F

CALCulate<1|2>:MARKer<1...4>:FUNction:POWer:RESult:PHZ ON | OFF

This command switches the query response of the power measurement results in the indicated measurement window between output of absolute values (OFF) and output referred to the measurement bandwidth (ON).

The measurement results are output with `CALCulate:MARKer:FUNction:POWer:RESult?`

Parameter: **ON:** Results output referred to measurement bandwidth.
 OFF: Results output in absolute values.

Example of channel/adjacent channel measurement:

<code>"SENS2:POW:ACH:ACP 3"</code>	'Sets the number of adjacent channels in screen B to 3.
<code>"SENS2:POW:ACH:BAND 30KHZ"</code>	'Sets the bandwidth of the main channel to 30 kHz.
<code>"SENS2:POW:ACH:BAND:ACH 40KHZ"</code>	'Sets the bandwidth of all adjacent channels to 40 kHz.
<code>"SENS2:POW:ACH:BAND:ALT1 50KHZ"</code>	'Sets the bandwidth of all alternate adjacent channels to 50 kHz.
<code>"SENS2:POW:ACH:BAND:ALT2 60KHZ"</code>	'Sets the bandwidth of alternate adjacent channel 2 to 60 kHz.
<code>"SENS2:POW:ACH:SPAC 30KHZ"</code>	'Sets the spacing between channel and adjacent channel as well as between all adjacent channels to 30 kHz.
<code>"SENS2:POW:ACH:SPAC:ALT1 40KHZ"</code>	'Sets the spacing between adjacent channel and alternate adjacent channel as well as between all alternate adjacent channels to 40 kHz.
<code>"SENS2:POW:ACH:SPAC:ALT2 50KHZ"</code>	'Sets the spacing between alternate adjacent channel 1 and alternate adjacent channel 2 to 50 kHz.
<code>"SENS2:POW:ACH:MODE ABS"</code>	'Switches on absolute power measurement.
<code>"CALC2:MARK:FUNC:POW:SEL ACP"</code>	'Switches the adjacent channel power measurement in screen B.
<code>"INIT:CONT OFF"</code>	'Switches to single-sweep mode.
<code>"INIT;*WAI"</code>	'Starts a sweep and waits for the end.
<code>"CALC2:MARK:FUNC:POW:RES:PHZ ON"</code>	'Output of results referred to the channel bandwidth.
<code>"CALC2:MARK:FUNC:POW:RES? ACP"</code>	'Queries the result of the adjacent channel power measurement in screen B referred to the channel bandwidth.

If only the **channel power** is to be measured, all commands for defining the bandwidths of adjacent channels as well as the channel spacings are not necessary. The number of adjacent channels is set to 0 with `SENS2:POW:ACH:ACP 0`.

Characteristics: *RST value: -
 SCPI: device-specific

Mode: A-F

CALCulate<1|2>:MARKer<1...4>:FUNCTION:POWer[:STATe] OFF

This command switches off the power measurement in the selected measurement window.

Example: "CALC:MARK:FUNC:POW OFF"
'Switches off the power measurement in screen A.

Characteristics: *RST value: -
SCPI: device-specific

Mode: A-F

This command is an event and therefore has no *RST value.

CALCulate<1|2>:MARKer<1...4>:FUNCTION:POWer:PRESet NADC | TETRA | PDC | PHS | CDPD | FWCDma | RWCDma | F8CDma | R8CDma | F19Cdma | R19Cdma | FW3Gppcdma | RW3Gppcdma | D2CDma | S2CDma | M2CDma | FIS95A | RIS95A | FIS95C0 | RIS95C0 | FJ008 | RJ008 | FIS95C1 | RIS95C1 | TCDMa | NONE | AWLan | BWLan | WIMax | WIBro

This command selects the power measurement setting for a standard in the indicated measurement window and previously switches on the corresponding measurement, if required. The function is independent of the marker selection, i.e. the numeric suffix <1...4> of MARKer is irrelevant.

The configuration for a standard comprises of the parameters weighting filter, channel bandwidth and spacing, resolution and video bandwidth, as well as detector and sweep time.

Meaning of the CDMA standard abbreviations:

FIS95A, F8CDma	CDMA IS95A forward
RIS95A, R8CDma	CDMA IS95A reverse
FJ008, F19CDma	CDMA J-STD008 forward
RJ008, R19CDma	CDMA J-STD008 reverse
FIS95C0	CDMA IS95C Class 0 forward
RIS95C0	CDMA IS95C Class 0 reverse
FIS95C1	CDMA IS95C Class 1 forward
RIS95C1	CDMA IS95C Class 1 reverse
FWCDma	W-CDMA 4.096 MHz forward
RWCDma	W-CDMA 4.096 MHz reverse
FW3Gppcdma	W-CDMA 3.84 MHz forward
RW3Gppcdma	W-CDMA 3.84 MHz reverse
D2CDma	CDMA 2000 direct sequence
S2CDma	CDMA 2000 MC1 multi carrier with 1 carrier
M2CDma	CDMA 2000 MC3 multi carrier with 3 carriers
TCDMa	TD-SCDMA
AWLan	WLAN 802.11a
BWLan	WLAN 802.11b
WIMax	WiMAX (Worldwide Interoperability for Microwave Access) IEEE 802.16-2004/Cor1-2005
WIBro	WiMAX WiBro (Wireless Broadband) IEEE 802.16-2004/Cor1-2005



The settings for standards IS95A and C differ as far as the calculation method of channel spacings is concerned. For IS95A and J-STD008 the spacing is calculated from the center of the main channel to the center of the corresponding adjacent channel, for IS95C from the center of the main channel to the nearest border of the adjacent channel.

Example: "CALC2:MARK:FUNC:POW:PRES NADC"
'Selects the standard setting for NADC in screen B

Characteristics: *RST value: -
SCPI: device-specific

Mode: A-F

CALCulate<1|2>:MARKer<1...4>:FUNction:POWer:MODE WRITe | MAXHold

This command selects the Clear Write or Maxhold for Channel Power values.

Example: "CALC:MARK:FUNC:POW:MODE MAXH"
'Maxhold for Channel Power values

Characteristics: *RST value: WRITe
SCPI: device-specific

Mode: A-F

CALCulate<1|2>:MARKer<1...4>:FUNction:POWer:STANdard:CATalog?

This command returns all predefine ACP standards and all user standards. The numeric suffixes at MARKer are irrelevant for this command.

Example: "CALC:MARK:FUNC:POW:STAN:CAT?"
'get all available ACP standards

Characteristics: *RST value:-
SCPI: device-specific

Mode: A

CALCulate<1|2>:MARKer<1...4>:FUNction:POWer:STANdard:DELeTe <name>

This command removes the ACP user standard <name>. It is not possible to remove predefine ACP standards. The numeric suffixes at MARKer are irrelevant for this command.

Example: "CALC:MARK:FUNC:POW:SEL ACP"
' activate ACP measurement
"CALC:MARK:FUNC:POW:PRES FW3G"
' use WCDMA 3GPP as basis
"CALC:LIM:ACP:ACH:REL -60,-60"
' change ACP limit to -60dBc
"CALC:MARK:FUNC:POW:STAN:SAVE 'my_acp_std"
' save as ACP USER standard my_acp_std
"CALC:MARK:FUNC:POW:STAN:DEL 'my_acp_std"
' delete the user standard my_acp_std

Characteristics: *RST value: OFF
SCPI: device-specific

Mode: A

CALCulate<1|2>:MARKer<1 to 4>:FUNCtion:POWER:STANdard:SAVE <file_name>

This command saves the current ACP settings as an ACP user standard. The numeric suffixes at MARKer are irrelevant for this command.

Example:

```
"CALC:MARK:FUNC:POW:SEL ACP"
' activate ACP measurement
"CALC:MARK:FUNC:POW:PRES FW3G"
' use WCDMA 3GPP as basis
"CALC:LIM:ACP:ACH:REL -60,-60"
' change ACP limit to -60dBc
"CALC:MARK:FUNC:POW:STAN:SAVE 'my_acp_std"
' save as ACP user standard my_acp_std
```

Characteristics: *RST value: -
SCPI: device-specific

Mode: A-F

CALCulate<1|2>:MARKer<1 to 4>:FUNCtion:POWER:PRESet NADC | TETRA | PDC | PHS | CDPD | FWCDma | RWCDma | F8CDma | R8CDma | F19CDma | R19CDma | FW3Gppcdma | RW3Gppcdma | D2CDma | S2CDma | M2CDma | FIS95A | RIS95A | FIS95C0 | RIS95C0 | FJ008 | RJ008 | FIS95C1 | RIS95C1 | TCDMa | NONE | AWLan | BWLan | WIMax | WIBro | EUTRa | REUTra | 'string'

Meaning of the CDMA standard abbreviations:

FIS95A, F8CDma	CDMA IS95A forward
RIS95A, R8CDma	CDMA IS95A reverse
FJ008, F19CDma	CDMA J-STD008 forward
RJ008, R19CDma	CDMA J-STD008 reverse
FIS95C0	CDMA IS95C Class 0 forward
RIS95C0	CDMA IS95C Class 0 reverse
FIS95F1	CDMA IS95C Class 1 forward
FIS95C1	CDMA IS95C Class 1 reverse
FWCDma	W-CDMA 4.096 MHz forward
RWCDma	W-CDMA 4.096 MHz reverse
FW3Gppcdma	W-CDMA 3.84 MHz forward
RW3Gppcdma	W-CDMA 3.84 MHz reverse
D2CDma	CDMA2000 direct sequence
S2CDma	CDMA2000 MC1 multi carrier with 1 carrier
M2CDma	CDMA2000 MC3 multi carrier with 3 carriers
TCDMa	TD-SCDMA
AWLan	WLAN 802.11a
BWLan	WLAN 802.11b
WIMax	WiMAX (Worldwide Interoperability for Microwave Access) IEEE 802.16-2004/Cor1-2005
WIBro	WiMAX WiBro (Wireless Broadband) IEEE 802.16-2004/Cor1-2005

EUTra	E-UTRA/LTE Square Use this standard setting to measure the assumed adjacent channel carrier configuration, E-UTRA of same BW. In this mode, on all channels a square filter is applied.
REUTra	E-UTRA/LTE Square/RRC Use this standard setting to measure the assumed adjacent channel carrier configuration, 1.28, 3.84, 7.68, Mcps UTRA. In this mode, a square filter is applied to the Tx channel and a RRC filter is applied to the adjacent, alternate channels.
<string>	<string> is the file name of a customized standard that has been saved with <i>SAVE AS USER STD.</i>

Example: "CALC:MARK:FUNC:POW:PRES BWLan"
Selects the standard setting for WLAN 802.11b.

Characteristics: *RST value: -
SCPI: device-specific

Mode: A-F

6.5.4.4 CALCulate:MARKer:FUNcTion:STRack Subsystem

The CALCulate:MARKer:FUNcTion:STRack subsystem defines the settings of the signal track.

CALCulate<1|2>:MARKer<1...4>:FUNcTion:STRack[:STATe] ON | OFF

This command switches the signal-track function on or off for the selected measurement window. The function is independent of the selected marker, i.e. the numeric suffix <1...4> of MARKer is irrelevant.

With signal track activated, the maximum signal is determined after each frequency sweep and the center frequency is set to the frequency of this signal. Thus with drifting signals the center frequency follows the signal.

Example: "CALC:MARK:FUNC:STR ON"
'Switches on the signal track function for screen A.

Characteristics: *RST value: OFF
SCPI: device-specific

Mode: A-F

CALCulate<1|2>:MARKer<1...4>:FUNcTion:STRack:BANDwidth|BWIDth 10Hz to MAX(SPAN)

These commands have the same function. For the selected measurement window they define the bandwidth around the center frequency within which the largest signal is searched. The function is independent of the selected marker, i.e. the numeric suffix <1...4> of MARKer is irrelevant. It is only available in the frequency domain (span > 0).



The entry of the search bandwidth is only possible if the Signal Track function is switched on (CALC:MARK:FUNC:STR ON).

Example: "CALC:MARK:FUNC:STR:BAND 1MHZ"
'Sets the search bandwidth for screen A to 1 MHz.

"CALC:MARK:FUNC:STR:BWID 1MHZ"
'Alternative command for the same function.

Characteristics: *RST value: -- (= span/10 on activating the function)
SCPI: device-specific

Mode: A-F

CALCulate<1|2>:MARKer<1...4>:FUNcTion:STRack:THReshold -330dBm to +30dBm

This command defines the threshold above which the largest signal is searched for in the selected measurement window. The function is independent of the selected marker, i.e. the numeric suffix <1...4> of MARKer is irrelevant. It is only available in the frequency domain (span > 0).

The response unit depends on the settings defined with CALC:UNIT.



The entry of the search bandwidth is only possible if the Signal Track function is switched on (CALC:MARK:FUNC:STR ON).

Example: "CALC:MARK:FUNC:STR:THR -50DBM"
'Sets the threshold for signal tracking in screen A to -50 dBm.

Characteristics: *RST value: -120 dBm
SCPI: device-specific

Mode: A-F

CALCulate<1|2>:MARKer<1...4>:FUNCtion:STRack:TRACe 1 to 3

This command defines the trace on which the largest signal is searched for in the selected measurement window. The function is independent of the selected marker, i.e. the numeric suffix <1...4> of MARKer is irrelevant. It is only available in the frequency domain (span > 0).

Example: "CALC2:MARK:FUNC:STR:TRAC 3"
'Defines trace 3 in screen B as the trace for signal tracking.

Characteristics: *RST value: 1
SCPI: device-specific

Mode: A-F

6.5.4.5 CALCulate:MARKer:FUNCtion:SUMMary Subsystem

This subsystem contains the commands for controlling the time domain power functions. These are provided in the marker subsystem for reasons of compatibility with the FSE family.

CALCulate<1|2>:MARKer<1...4>:FUNCtion:SUMMary[:STATe] ON | OFF

This command switches on or off the previously selected time domain power measurements. Thus one or several measurements can be first selected and then switched on and off together with `CALC:MARK:FUNC:SUMM:STATe`.

The function is independent of the marker selection, i.e. the suffix of `MARKer` is irrelevant. It is only available in the time domain (span = 0).

Example: `"CALC:MARK:FUNC:SUMM:STAT ON"`

Characteristics: *RST value: OFF
SCPI: device-specific

Mode: A-T

CALCulate<1|2>:MARKer<1...4>:FUNCtion:SUMMary:PPEak[:STATe] ON | OFF

This command switches on or off the measurement of the positive peak value in the selected measurement window.

The function is independent of the marker selection, i.e. the numeric suffix <1...4> of `MARKer` is irrelevant. It is only available in the time domain (span = 0).

Example: `"CALC:MARK:FUNC:SUMM:PPE ON"`
'Switches on the function in screen A.

Characteristics: *RST value: OFF
SCPI: device-specific

Mode: A-T

CALCulate<1|2>:MARKer<1...4>:FUNCtion:SUMMary:PPEak:RESult?

This command is used to query the result of the measurement of the positive peak value in the selected measurement window. The measurement may have to be switched on previously.

The function is independent of the marker selection, i.e. the numeric suffix <1...4> of `MARKer` is irrelevant. It is only available in the time domain (span = 0).

A complete sweep with synchronization to sweep end must be performed between switching on the function and querying the measured value to obtain a valid query result. This is only possible in single-sweep mode.

Example: `"INIT:CONT OFF"`
'Switches to single-sweep mode.

`"CALC:MARK:FUNC:SUMM:PPE ON"`
'Switches on the function in screen A.

`"INIT;*WAI"`
'Starts a sweep and waits for the end.

`"CALC:MARK:FUNC:SUMM:PPE:RES?"`
'Outputs the result of screen A.

Characteristics: *RST value: -
SCPI: device-specific

Mode: A-T

This command is only a query and therefore has no *RST value.

CALCulate<1|2>:MARKer<1...4>:FUNCTion:SUMMery:PPEak:AVERage:RESult?

This command is used to query the result of the measurement of the averaged positive peak value in the selected measurement window. The query is only possible if averaging has been activated previously using `CALCulate<1|2>:MARKer<1...4>:FUNCTion:SUMMery:AVERage`.

The function is independent of the marker selection, i.e. the numeric suffix <1...4> in `MARKer` is irrelevant. It is only available in the time domain (span = 0).

A complete sweep with synchronization to sweep end must be performed between switching on the function and querying the measured value to obtain a valid query result. This is only possible in single-sweep mode.

Example:

```
"INIT:CONT OFF"
'Switches to single-sweep mode.

"CALC:MARK:FUNC:SUMM:PPE ON"
'Switches on the function in screen A.

"CALC:MARK:FUNC:SUMM:AVER ON"
'Switches on the calculation of average in screen A.

"INIT;*WAI"
'Starts a sweep and waits for the end.

"CALC:MARK:FUNC:SUMM:PPE:AVER:RES?"
'Outputs the result of screen A.
```

Characteristics: *RST value: -
SCPI: device-specific

Mode: A-T

This command is only a query and therefore has no *RST value.

CALCulate<1|2>:MARKer<1...4>:FUNction:SUMMary:PPEak:PHOLd:RESult?

This command is used to query the result of the measurement of the positive peak value with active peak hold function. The query is only possible if the peak hold function has been activated previously using `CALCulate<1|2>:MARKer<1...4>:FUNction:SUMMary:PHOLd`.

The function is independent of the marker selection, i.e. the numeric suffix <1...4> of `:MARKer` is irrelevant. It is only available in the time domain (span = 0).

A complete sweep with synchronization to sweep end must be performed between switching on the function and querying the measured value to obtain a valid query result. This is only possible in single-sweep mode.

Example:

```
"INIT:CONT OFF"
'Switches to single-sweep mode.

"CALC:MARK:FUNC:SUMM:PPE ON"
'Switches on the function in screen A.

"CALC:MARK:FUNC:SUMM:PHOL ON"
'Switches on the measurement of the peak value in screen A.

"INIT;*WAI"
'Starts a sweep and waits for the end.

"CALC:MARK:FUNC:SUMM:PPE:PHOL:RES?"
'Outputs the result of screen A.
```

Characteristics: *RST value: -
SCPI: device-specific

Mode: A-T

This command is only a query and therefore has no *RST value.

CALCulate<1|2>:MARKer<1...4>:FUNction:SUMMary:RMS[:STATe] ON | OFF

This command switches on or off the measurement of the effective (RMS) power in the selected measurement window. If necessary the function is switched on previously.

The function is independent of the marker selection, i.e. the numeric suffix <1...4> of `:MARKer` is irrelevant. It is only available in the time domain (span = 0).

Example:

```
"CALC2:MARK:FUNC:SUM:RMS ON"
'Switches on the function in screen B.
```

Characteristics: *RST value: OFF
SCPI: device-specific

Mode: A-T

CALCulate<1|2>:MARKer<1...4>:FUNction:SUMMary:RMS:RESult?

This command queries the result of the measurement of the RMS power value in the selected measurement window.

The function is independent of the marker selection, i.e. the numeric suffix <1...4> of `:MARKer` is irrelevant. It is only available in the time domain (span = 0).

A complete sweep with synchronization to sweep end must be performed between switching on the function and querying the measured value to obtain a valid query result. This is only possible in single-sweep mode.

Example: "INIT:CONT OFF"
'Switches to single-sweep mode.

"CALC:MARK:FUNC:SUMM:RMS ON"
'Switches on the function in screen A.

"INIT;*WAI"
'Starts a sweep and waits for the end.

"CALC:MARK:FUNC:SUMM:RMS:RES?"
'Outputs the result of screen A.

Characteristics: *RST value: -
SCPI: device-specific

Mode: A-T

This command is only a query and therefore has no *RST value.

CALCulate<1|2>:MARKer<1...4>:FUNCTION:SUMMARY:RMS:AVERAGE:RESULT?

This command queries the result of the measurement of the averaged RMS value in the selected measurement window. The query is only possible if averaging has been activated previously using CALCulate:MARKer:FUNCTION:SUMMARY:AVERAGE ON.

The function is independent of the marker selection, i.e. the numeric suffix <1...4> of :MARKer is irrelevant. It is only available in the time domain (span = 0).

A complete sweep with synchronization to sweep end must be performed between switching on the function and querying the measured value to obtain a valid query result. This is only possible in single-sweep mode.

Example: "INIT:CONT OFF"
'Switches to single-sweep mode.

"CALC:MARK:FUNC:SUMM:RMS ON"
'Switches on the function in screen A.

"CALC:MARK:FUNC:SUMM:AVER ON"
Switches on the average value calculation in screen A.

"INIT;*WAI"
'Starts a sweep and waits for the end.

"CALC:MARK:FUNC:SUMM:RMS:AVER:RES?"
'Outputs the result of screen A.

Characteristics: *RST value: -
SCPI: device-specific

Mode: A-T

This command is only a query and therefore has no *RST value.

CALCulate<1|2>:MARKer<1...4>:FUNCTION:SUMMARY:RMS:PHOLD:RESULT?

This command queries the result of the measurement of the RMS value with active peak hold in the selected measurement window. The query is only possible only if the peak hold function has been activated previously using CALCulate<1|2>:MARKer<1...4>:FUNCTION:SUMMARY:PHOLD.

The function is independent of the marker selection, i.e. the numeric suffix <1...4> of :MARKer is irrelevant. It is only available in the time domain (span = 0).

A complete sweep with synchronization to sweep end must be performed between switching on the function and querying the measured value to obtain a valid query result. This is only possible in single-sweep mode.

Example:

```
"INIT:CONT OFF"
'Switches to single-sweep mode.

"CALC:MARK:FUNC:SUMM:RMS ON"
'Switches on the function in screen A.

"CALC:MARK:FUNC:SUMM:PHOL ON"
'Switches on the peak value measurement in screen A.

"INIT;*WAI"
'Starts a sweep and waits for the end.

"CALC:MARK:FUNC:SUMM:RMS:PHOL:RES?"
'Outputs the result of screen A.
```

Characteristics: *RST value: -
SCPI: device-specific

Mode: A-T

This command is only a query and therefore has no *RST value.

CALCulate<1|2>:MARKer<1...4>:FUNCtion:SUMMary:MEAN[:STATe] ON | OFF

This command switches on or off the measurement of the mean value in the selected measurement window.

The function is independent of the marker selection, i.e. the numeric suffix <1...4> of :MARKer is irrelevant. It is only available in the time domain (span = 0).



The measurement is performed on the trace on which marker 1 is positioned. In order to evaluate another trace, marker 1 must be positioned on another trace with `CALC:MARK:TRAC 1|2|3`.

Example:

```
"CALC:MARK:FUNC:SUMM:MEAN ON"
'Switches on the function in screen A.
```

Characteristics: *RST value: OFF
SCPI: device-specific

Mode: A-T

CALCulate<1|2>:MARKer<1...4>:FUNction:SUMMery:MEAN:RESult?

This command queries the result of the measurement of the mean value in the selected measurement window.

The function is independent of the marker selection, i.e. the numeric suffix <1...4> of :MARKer is irrelevant. It is only available in the time domain (span = 0).

A complete sweep with synchronization to sweep end must be performed between switching on the function and querying the measured value to obtain a valid query result. This is only possible in single-sweep mode.

Example:

```
"INIT:CONT OFF"
'Switches to single-sweep mode.

"CALC:MARK:FUNC:SUMM:MEAN ON"
'Switches on the function in screen A.

"INIT;*WAI"
'Starts a sweep and waits for the end.

"CALC:MARK:FUNC:SUMM:MEAN:RES?"
'Outputs the result of screen A.
```

Characteristics: *RST value: -
SCPI: device-specific

Mode: A-T

This command is only a query and therefore has no *RST value.

CALCulate<1|2>:MARKer<1...4>:FUNction:SUMMery:MEAN:AVERage:RESult?

This command queries the result of the measurement of the averaged mean value in the selected measurement window. The query is only possible if averaging has been activated previously using CALCulate<1|2>:MARKer<1...4>:FUNction:SUMMery:AVERage.

The function is independent of the marker selection, i.e. the numeric suffix <1...4> of :MARKer is irrelevant. It is only available in the time domain (span = 0).

A complete sweep with synchronization to sweep end must be performed between switching on the function and querying the measured value to obtain a valid query result. This is only possible in single-sweep mode.

Example:

```
"INIT:CONT OFF"
'Switches to single-sweep mode.

"CALC:MARK:FUNC:SUMM:MEAN ON"
'Switches on the function in screen A.

"CALC:MARK:FUNC:SUMM:AVER ON"
'Switches on the average value calculation in screen A.

"INIT;*WAI"
'Starts a sweep and waits for the end.

"CALC:MARK:FUNC:SUMM:MEAN:AVER:RES?"
'Outputs the result of screen A.
```

Characteristics: *RST value: -
SCPI: device-specific

Mode: A-T

This command is only a query and therefore has no *RST value.

CALCulate<1|2>:MARKer<1...4>:FUNCTION:SUMMARY:MEAN:PHOLD:RESult?

This command queries the result of the measurement of the mean value with active peak hold in the selected measurement window. The query is only possible if the peak hold function has been switched on previously using `CALCulate<1|2>:MARKer<1...4>:FUNCTION:SUMMARY:AVERAGE`

The query is possible only if the peak hold function is active. The function is independent of the marker selection, i.e. the numeric suffix <1...4> of `:MARKer` is irrelevant. It is only available in the time domain (span = 0).

A complete sweep with synchronization to sweep end must be performed between switching on the function and querying the measured value to obtain a valid query result. This is only possible in single-sweep mode.

Example:

```
"INIT:CONT OFF"
'Switches to single-sweep mode

"CALC:MARK:FUNC:SUMM:MEAN ON"
'Switches on the function in screen A

"CALC:MARK:FUNC:SUMM:PHOL ON"
'Switches on the peak value measurement in screen A

"INIT;*WAI"
'Starts a sweep and waits for the end

"CALC:MARK:FUNC:SUMM:MEAN:PHOL:RES?"
'Outputs the result of screen A.
```

Characteristics: *RST value: -
SCPI: device-specific

Mode: A-T

This command is only a query and therefore has no *RST value.

CALCulate<1|2>:MARKer<1...4>:FUNCTION:SUMMARY:SDEVIation[:STATe] ON | OFF

This command switches on or off the measurement of the standard deviation in the selected measurement window. The function is independent of the marker selection, i.e. the numeric suffix <1...4> of `:MARKer` is irrelevant. It is only available in the time domain (span = 0).

On switching on the measurement, the mean power measurement is switched on as well.

Example:

```
"CALC2:MARK:FUNC:SUMM:SDEV ON"
'Switches on the measurement of the standard deviation in screen B.
```

Characteristics: *RST value: OFF
SCPI: device-specific

Mode: A

CALCulate<1|2>:MARKer<1...4>:FUNCTION:SUMMARY:SDEVIation:RESult?

This command queries the results of the standard deviation measurement. The function is independent of the marker selection, i.e. the numeric suffix <1...4> of :MARKer is irrelevant. It is only available in the time domain (span = 0).

A complete sweep with synchronization to sweep end must be performed between switching on the function and querying the measured value to obtain a valid query result. This is only possible in single-sweep mode.

Example:

```
"INIT:CONT OFF"
'Switches to single-sweep mode.

"CALC:MARK:FUNC:SUMM:SDEV ON"
'Switches on the function in screen A.

"INIT;*WAI"
'Starts a sweep and waits for the end.

"CALC:MARK:FUNC:SUMM:SDEV:RES?"
'Outputs the result of screen A.
```

Characteristics: *RST value: -
SCPI: device-specific

Mode: A-T

This command is only a query and therefore has no *RST value.

CALCulate<1|2>:MARKer<1...4>:FUNCTION:SUMMARY:SDEVIation:AVERAge:RESult?

This command queries the result of the averaged standard deviation determined in several sweeps in the selected measurement window. The query is possible only if averaging is active. The function is independent of the marker selection, i.e. the numeric suffix <1...4> of :MARKer is irrelevant. It is only available in the time domain (span = 0).

A complete sweep with synchronization to sweep end must be performed between switching on the function and querying the measured value to obtain a valid query result. This is only possible in single-sweep mode.

Example:

```
"INIT:CONT OFF"
'Switches to single-sweep mode.

"CALC:MARK:FUNC:SUMM:SDEV ON"
'Switches on the function in screen A.

"CALC:MARK:FUNC:SUMM:AVER ON"
'Switches on the calculation of average in screen A.

"INIT;*WAI"
'Starts a sweep and waits for the end.

"CALC:MARK:FUNC:SUMM:MEAN:SDEV:RES?"
'Outputs the result of screen A.
```

Characteristics: *RST value: -
SCPI: device-specific

Mode: A-T

This command is only a query and therefore has no *RST value.

CALCulate<1|2>:MARKer<1...4>:FUNCtion:SUMMary:SDEViation:PHOLd:RESult?

This command queries the maximum standard deviation value determined in several sweeps in the selected measurement window. The query is possible only if the peak hold function is active.

The function is independent of the marker selection, i.e. the numeric suffix <1...4> of :MARKer is irrelevant. It is only available in the time domain (span = 0).

A complete sweep with synchronization to sweep end must be performed between switching on the function and querying the measured value to obtain a valid query result. This is only possible in single-sweep mode.

Example:

```
"INIT:CONT OFF"
'Switches to single-sweep mode.

"CALC:MARK:FUNC:SUMM:SDEV ON"
'Switches on the function in screen A.

"CALC:MARK:FUNC:SUMM:PHOL ON"
'Switches on the peak value measurement in screen A.

"INIT;*WAI"
'Starts a sweep and waits for the end.

"CALC:MARK:FUNC:SUMM:SDEV:PHOL:RES?"
'Outputs the result of screen A.
```

Characteristics: *RST value: -
SCPI: device-specific

Mode: A-T

This command is only a query and therefore has no *RST value.

CALCulate<1|2>:MARKer<1...4>:FUNCtion:SUMMary:PHOLd ON | OFF

This command switches on or off the peak-hold function for the active time domain power measurement in the indicated measurement window. The function is independent of the marker selection, i.e. the numeric suffix <1...4> of :MARKer is irrelevant. It is only available in the time domain (span = 0). The peak-hold function is reset by switching it off and on again.

Example:

```
"CALC:MARK:FUNC:SUMM:PHOL ON"
'Switches on the function in screen A.
```

Characteristics: *RST value: OFF
SCPI: device-specific

Mode: A-T

The peak-hold function is reset by switching off and on, again.

CALCulate<1|2>:MARKer<1...4>:FUNCtion:SUMMary:AVERage ON | OFF

This command switches on or off averaging for the active time domain power measurement in the indicated window. The function is independent of the marker selection, i.e. the numeric suffix <1...4> of :MARKer is irrelevant. It is only available in the time domain (span = 0).

Averaging is reset by switching it off and on again.

The number of results required for the calculation of average is defined with [SENSe<1|2>:]AVERage:COUNT.

It should be noted that synchronization to the end of averaging is only possible in single-sweep mode.

Example:

```
"INIT:CONT OFF"
'Switches to single-sweep mode.

"CALC2:MARK:FUNC:SUMM:AVER ON"
'Switches on the calculation of average in screen B.

"AVER:COUN 200"
'Sets the measurement counter to 200.

"INIT;*WAI"
'Starts a sweep and waits for the end.
```

Characteristics: *RST value: OFF
SCPI: device-specific

Mode: A-T

CALCulate<1|2>:MARKer<1...4>:FUNCtion:SUMMary:MODE ABSolute | RELative

This command selects absolute or relative time domain power measurement in the indicated measurement window. The function is independent of the marker selection, i.e. the numeric suffix <1...4> of :MARKer is irrelevant. It is only available in the time domain (span = 0).

The reference power for relative measurement is defined with CALCulate:MARKer:FUNCtion:SUMMary:REFeRence:AUTO ONCE. If the reference power is not defined, the value 0 dBm is used.

Example:

```
"CALC:MARK:FUNC:SUMM:MODE REL"
'Switches the time domain power measurement to relative.
```

Characteristics: *RST value: ABSolute
SCPI: device-specific

Mode: A-T

CALCulate<1|2>:MARKer<1...4>:FUNCTION:SUMMARY:REFERENCE:AUTO ONCE

With this command the currently measured average value (...:SUMMARY:MEAN) and RMS value (...:SUMMARY:RMS) are declared as reference values for relative measurements in the indicated measurement window. The function is independent of the marker selection, i.e. the numeric suffix <1 to 4> of :MARKer is irrelevant. It is only available in the time domain (span = 0).

If the measurement of RMS value and average is not activated, the reference value 0 dBm is used.

If the function ...:SUMMARY:AVERAGE or ...:SUMMARY:PHOLD is switched on, the current value is the accumulated measurement value at the time considered.

Example: "CALC:MARK:FUNC:SUMM:REF:AUTO ONCE"
'Takes the currently measured power in screen A as reference value for the relative time domain power measurement.

Characteristics: *RST value: -
SCPI: device-specific

Mode: A-T

This command is an event and therefore has no *RST value and no query.

CALCulate<1|2>:MARKer<1...4>:FUNCTION:SUMMARY:AOFF

This command switches off all time domain measurements in the selected measurement window. The function is independent of the marker selection, i.e. the numeric suffix <1...4> of :MARKer is irrelevant. It is only available in the time domain (span = 0).

Example: "CALC2:MARK:FUNC:SUMM:AOFF"
'Switches off the time domain power measurement functions in screen B.

Characteristics: *RST value: _
SCPI: device-specific

Mode: A-T

This command is an event and therefore has no *RST value and no query.

CALCulate<1|2>:MARKer<1...4>:FUNCTION:MSUMmary? <time offset of first pulse>, <measurement time>, <period>, < # of pulses to measure>

The commands of this subsystem are used to determine the power of a sequence of signal pulses having the same interval. The number of pulses to be measured as well as the measurement time and the period can be set. To define the position of the first pulse in the trace, a suitable offset can be entered.

The evaluation is performed on the measurement data of a previously recorded trace. The data recorded during the set measurement time is combined to a measured value for each pulse according to the detector specified and the indicated number of results is output as a list.

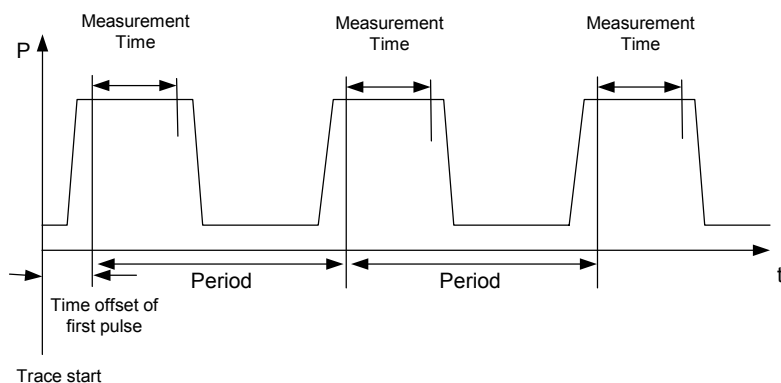

TRACE 1 of the selected screen is always used by the function. The suffix of MARKer will be ignored.

Example:

```
"DISP:WIND:TRAC:Y:RLEV -10dBm"
'Sets the reference level to 10 dBm

"INP:ATT 30 dB"
'Sets the input attenuation to 30 dB

"FREQ:CENT 935.2MHz;SPAN 0Hz"
'Sets the receive frequency to 935.2 MHz and the span to 0 Hz

"BAND:RES 1MHz;VID 3MHz"
'Sets the resolution bandwidth to 1 MHz and the video bandwidth to 3 MHz

"DET RMS"
'Sets the RMS detector

"TRIG:SOUR VID;LEV:VID 50 PCT"
'Selects the trigger source VIDEo and sets the level of the video trigger source to 50 PCT

"SWE:TIME 50ms"
'Sets the sweep time to 50 ms

"INIT;*WAI"
'Starts the measurement with synchronization

"CALC:MARK:FUNC:MSUM? 50US,450US,576.9US,8"
'Queries 8 bursts with an offset of 50  $\mu$ s, a test time of 450  $\mu$ s and a period of 576.9  $\mu$ s
```

Characteristics: *RST value: -
SCPI: device-specific

Mode: A-T

6.5.5 CALCulate:MATH Subsystem

The CALCulate:MATH subsystem allows to process data from the SENSE-subsystem in numeric expressions.

The measurement windows are selected by CALCulate1 (screen A) and CALCulate2 (screen B).

CALCulate<1|2>:MATH[:EXpression][:DEFine] (<expr>)

This command defines the mathematical expression for relating traces to trace1.

The CALCulate<1|2>:MATH:STATe command switches the mathematical relation of traces on or off.

The measurement windows are selected via CALCulate1 (screen A) or 2 (screen B).

Parameter: <expr>::= 'OP1 - OP2'
OP1 ::= TRACE1
OP2 ::= TRACE2 | TRACE3

Example: "CALC1:MATH (TRACE1 - TRACE2) "
'Selects the subtraction of trace 1 from trace 2 in screen A.

"CALC2:MATH (TRACE1 - TRACE3) "
'Selects the subtraction of trace 1 from trace 3 in screen B.

Characteristics: *RST value: -
SCPI: conform

Mode: A-T

CALCulate<1|2>:MATH:POSition -100PCT to 200PCT

This command defines the position of the result of the trace mathematics in the selected measurement window. The indication is in % of the screen height, with 100% corresponding to the upper diagram border.

Example: "CALC:MATH:POS 50PCT"
'Sets the position in screen A to the horizontal diagram center.

Characteristics: *RST value: 50 %
SCPI: device-specific

Mode: A-T

CALCulate<1|2>:MATH:STATe ON | OFF

This command switches the mathematical relation of traces on or off.

The measurement windows are selected via CALCulate1 (screen A) or 2 (screen B).

Example: "CALC:MATH:STAT ON"
'Switches on the trace mathematics in screen A.

Characteristics: *RST value: OFF
SCPI: conform

Mode: A-T

CALCulate<1|2>:MATH:MODE LINear | LOGarithmic | POWER

This command selects linear or logarithmic (= video) calculation of the mathematical functions related to the traces. The calculation of the average is one of the affected functions. The setting is valid for all measurement windows, i.e. the numeric suffix <1|2> of CALCulate is irrelevant.

Example: "CALC:MATH:MODE LIN"
'Switches on the linear calculation.'

Characteristics: *RST value: LOG
SCPI: device-specific

Mode: A-T

6.5.6 CALCulate:PEAKsearch | PSEarch Subsystem

The CALCulate:PEAKsearch subsystem contains commands for verifying scan results in the test receiver mode.

CALCulate<1|2>:PEAKsearch|PSEarch:AUTO ON | OFF

By using this command, the peak list in the spurious measurement is calculated automatically after a measurement. For each range, exactly one peak value is calculated.

The SENSE suffix is unused.

Example: "CALC:PEAK:AUTO ON"
'Switches the automatic peak search on.

Characteristics: *RST value: OFF
SCPI: device-specific

Mode: A

CALCulate<1|2>:PEAKsearch|PSEarch:ADD <numeric value>

This command adds a frequency value to the peaklist in receiver mode (RECEIVER – FINAL MEAS – EDIT PEAK LIST). Only frequencies in the currently displayed frequency range of the receiver scan are allowed.

Example: "CALC:PEAK:ADD 93MHz"
'The frequency 93 MHz as added to the peak list.

Characteristics: *RST value: --
SCPI: device-specific

Mode: R

CALCulate<1|2>:PEAKsearch|PSEarch:CLEAR[:IMMEDIATE]

The peaklist in receiver mode (RECEIVER – FINAL MEAS – EDIT PEAK LIST) is cleared.

Example: "CALC:PEAK:CLEAR"
'The peak list is cleared.

Characteristics: *RST value: --
SCPI: device-specific

Mode: R

CALCulate<1|2>:PEAKsearch|PSEarch[:IMMEDIATE]

This command activates the generation of a peak list.

The numeric suffix in CALCULATE<1 | 2> is not significant.

Example: "CALC:PEAK"

Characteristics: *RST value: -
SCPI: device-specific

Mode: A, R

This command is an event and therefore has no *RST value and no query.

CALCulate<1|2>:PEAKsearch|PSEarch:MARGIN MINimum .. MAXimum

This command defines the margin for the peak search.

The numeric suffix in CALCULATE<1 | 2> is not significant.

Example: "CALC:PEAK:MARG 5 dB"

Characteristics: *RST value: 6 dB
SCPI: device-specific

Mode: A, R

CALCulate<1|2>:PEAKsearch|PSEarch:SUBRanges 1 to 500

This command defines the number of subranges for the peak search.

The numeric suffix in CALCULATE<1 | 2> is not significant.

Example: "CALC:PEAK:SUBR 10"

Characteristics: *RST value: 25
SCPI: device-specific

Mode: A, R

CALCulate<1|2>:PEAKsearch|PSEarch:METHod SUBRange | PEAK

This command defines the method that is used to determine the level maxima of a scan.

The numeric suffix in CALCULATE<1 | 2> is not significant.

Example: "CALC:PEAK:METH SUBR"

Characteristics: *RST value: PEAK
SCPI: device-specific

Mode: R

6.5.7 CALCulate:STATistics Subsystem

The CALCulate:STATistics subsystem controls the statistical measurement functions in the instrument. The measurement window cannot be selected with these functions. The numeric suffix in CALCulate is therefore ignored.

CALCulate:STATistics:APD[:STATe] ON | OFF

This command switches on or off the measurement of amplitude distribution (APD). On activating this function, the CCDF measurement is switched off.

Example: "CALC:STAT:APD ON"
'Switches on the APD measurement.

Characteristics: *RST value: OFF
SCPI: device-specific

Mode: A

CALCulate:STATistics:CCDF[:STATe] ON | OFF

This command switches on or off the measurement of the complementary cumulative distribution function (CCDF). On activating this function, the APD measurement is switched off.

Example: "CALC:STAT:CCDF ON"
'Switches on the CCDF measurement.

Characteristics: *RST value: OFF
SCPI: device-specific

Mode: A

CALCulate:STATistics:CCDF:X<1...3>? P0_01 | P0_1 | P1 | P10

This command reads out the level values for the probabilities 0.01%, 0.1%, 1% and 10%. The trace is selected by means of the numeric suffix <1...3>.

The desired result is selected by means of the following parameters:

Parameter: P0_01: Level value for 0.01% probability
P0_1: Level value for 0.1% probability
P1: Level value for 1% probability
P10: Level value for 10% probability

Example: "CALC:STAT:CCDF:X? P1"
'Reads out the level values for 1% probability.

Characteristics: *RST value: --
SCPI: device-specific

Mode: A

CALCulate:STATistics:NSAMples 100 to 1E9

This command sets the number of measurement points to be acquired for the statistical measurement functions.

Example: "CALC:STAT:NSAM 500"
'Sets the number of measurement points to be acquired to 500.

Characteristics: *RST value: 100000
SCPI: device-specific

Mode: A

CALCulate:STATistics:SCALE:AUTO ONCE

This command optimizes the level setting of the instrument depending on the measured peak power, in order to obtain maximum instrument sensitivity.

To obtain maximum resolution, the level range is set as a function of the measured spacing between peak power and the minimum power for the APD measurement and of the spacing between peak power and mean power for the CCDF measurement. In addition, the probability scale for the number of test points is adapted.



Subsequent commands have to be synchronized with *WAI, *OPC or *OPC? to the end of the auto range process which would otherwise be aborted.

Example: "CALC:STAT:SCAL:AUTO ONCE;*WAI"
'Adapts the level setting for statistical measurements and activates the synchronization.

Characteristics: *RST value: --
SCPI: device-specific

Mode: A

This command is an event and therefore has no *RST value and no query.

CALCulate:STATistics:SCALE:X:RLEVel -130dBm to 30dBm

This command defines the reference level for the x-axis of the measurement diagram. The setting is identical to the reference level setting using the command DISPLAY:WINDOW:TRACE:Y:RLEVel.

With the reference level offset <> 0 the indicated value range of the reference level is modified by the offset.

The unit depends on the setting performed with CALC:UNIT.

Example: "CALC:STAT:SCAL:X:RLEV -60dBm"

Characteristics: *RST value: -20dBm
SCPI: device-specific

Mode: A

CALCulate:STATistics:SCALe:X:RANGe 1dB to 200dB

This command defines the level range for the x-axis of the measurement diagram. The setting is identical to the level range setting defined with the command `DISPlay:WINDow:TRACe:Y:SCALe`.

Example: `"CALC:STAT:SCAL:X:RANG 20dB"`

Characteristics: *RST value: 100dB
SCPI: device-specific

Mode: A

CALCulate:STATistics:SCALe:Y:UNIT PCT | ABS

This command toggles the scaling of y-axis between percentage and absolute.

Example: `"CALC:STAT:SCAL:Y:UNIT PCT"`
'toggle to percentage

Characteristics: *RST value: ABS
SCPI: device-specific

Mode: A

CALCulate:STATistics:SCALe:Y:UPPer 1E-8 to 1.0

This command defines the upper limit for the y-axis of the diagram in statistical measurements. Since probabilities are specified on the y-axis, the entered numerical values are dimensionless.

Example: `"CALC:STAT:Y:UPP 0.01"`

Characteristics: *RST value: 1.0
SCPI: device-specific

Mode: A

CALCulate:STATistics:SCALe:Y:LOWer 1E-9 to 0.1

This command defines the lower limit for the y-axis of the diagram in statistical measurements. Since probabilities are specified on the y-axis, the entered numerical values are dimensionless.

Example: `"CALC:STAT:SCAL:Y:LOW 0.001"`

Characteristics: *RST value: 1E-6
SCPI: device-specific

Mode: A

CALCulate:STATistics:PRESet

This command resets the scaling of the X and Y axes in a statistical measurement. The following values are set:

- x-axis ref level: -20 dBm
- x-axis range APD: 100 dB
- x-axis range CCDF: 20 dB
- y-axis upper limit: 1.0
- y-axis lower limit: 1E-6

Example: "CALC:STAT:PRES"
' Resets the scaling for statistical functions

Characteristics: *RST value: --
SCPI: device-specific

Mode: A

This command is an event and therefore has no *RST value and no query.

CALCulate:STATistics:RESult<1...3>? MEAN | PEAK | CFACtor | ALL

This command reads out the results of statistical measurements of a recorded trace. The trace is selected with the numeric suffix <1...3> attached to RESult.

The required result is selected via the following parameters:

Parameter: MEAN: Average (=RMS) power in dBm measured during the measurement time.
PEAK: Peak power in dBm measured during the measurement time.
CFACtor: Determined CREST factor (= ratio of peak power to average power) in dB.
ALL: Results of all three measurements mentioned before, separated by commas:
<mean power>,<peak power>,<crest factor>

Example: "CALC:STAT:RES2? ALL"
' Reads out the three measurement results of trace 2. Example of answer string:
5.56,19.25,13.69 i.e. mean power: 5.56 dBm, peak power 19.25 dBm, CREST
factor 13.69 dB

Characteristics: *RST value: --
SCPI: device-specific

Mode: A

CALCulate<1|2>:STATistics:X:MPOsition 0 ... 100

This command defines the relative X position of the mean power value for the CCDF measurement. The default position is 0% (left corner of the grid). This function is only available if the statistics measurement function CCDF is switched on.

Example: "CALC:STAT:X:MPOS 10.0"
' set the mean power position to 10%

Characteristics: *RST value: 0
SCPI: device-specific

Mode: A

6.5.8 CALCulate:THReshold Subsystem

The CALCulate:THReshold subsystem controls the threshold value for the maximum/minimum search of markers. The measurement windows are selected by CALCulate 1 (screen A) or 2 (screen B).

CALCulate<1|2>:DLINe<1|2> MINimum .. MAXimum (depending on current unit)

This command defines the position of Display Line 1 or 2. These lines enable the user to mark any levels in the diagram. The unit depends on the setting made with CALC:UNIT.

Example: "CALC:DLIN -20dBm"

Characteristics: *RST value: - (STATE to OFF)
SCPI: device-specific

Mode: R, A

CALCulate<1|2>:DLINe<1|2>:STATe ON | OFF

This command switches Display Line 1 or 2 (level lines) on or off.

Example: "CALC:DLIN2:STAT OFF"

Characteristics: *RST value: OFF
SCPI: device-specific

Mode: R, A

CALCulate<1|2>:THReshold MINimum to MAXimum (depending on current unit)

This command defines the threshold value for the maximum/minimum search of markers with marker search functions MAX PEAK, NEXT PEAK, etc. in the selected measurement window. The associated display line is automatically switched on.

Example: "CALC:THR -82DBM"
'Sets the threshold value for screen A to -82 dBm.

Characteristics: *RST value: - (STATE to OFF)
SCPI: device-specific

Mode: R, A

CALCulate<1|2>:THReshold:STATe ON | OFF

This command switches on or off the threshold line in the selected measurement window. The unit depends on the setting performed with CALC:UNIT.

Example: "CALC2:THR:STAT ON"
'Switches on the threshold line in screen B.

Characteristics: *RST value: OFF
SCPI: device-specific

Mode: R, A

CALCulate<1|2>:FLINe<1|2> 0 to f_{\max}

This command defines the position of the frequency lines.

The frequency lines mark the frequencies specified in the measurement window. Frequency lines are only available with SPAN > 0.

Example: "CALC:FLIN2 120MHz"

Characteristics: *RST value: - (STATE to OFF)
SCPI: device-specific

Mode: R, A-F

CALCulate<1|2>:FLINe<1|2>:STATe ON | OFF

This command switches the frequency line on or off.

Example: "CALC:FLIN2:STAT ON"

Characteristics: *RST value: OFF
SCPI: device-specific

Mode: R, A-F

CALCulate<1|2>:TLINe<1|2> 0 to 1000s

This command defines the position of the time lines.

The time lines mark the times specified in the measurement window. Time lines are only available with SPAN = 0.

Example: "CALC:TLIN 10ms"

Characteristics: *RST value: - (STATE auf OFF)
SCPI: device-specific

Mode: A-T

CALCulate<1|2>:TLINe<1|2>:STATe ON | OFF

This command switches the time line on or off.

Example: "CALC:TLIN2:STAT ON"

Characteristics: *RST value: OFF
SCPI: device-specific

Mode: A-T

6.5.9 CALCulate:UNIT Subsystem

The CALCulate:Unit subsystem defines the units for power measurement settings.

CALCulate<1|2>:UNIT:POWer DBM | V | A | W | DBPW | WATT | DBUV | DBMV | VOLT | DBUA | AMPere | DBPT | DBUV_M | DBUA_M

This command selects the unit for power in the selected measurement window.

In receiver mode, only the units DBM, DBUV, DBUA, DBPW, and DBPT are available.

Example: "CALC:UNIT:POW DBM"
 'Sets the power unit for screen A to dBm.

Characteristics: *RST value: dBm
 SCPI: device-specific

Mode: R, A

6.6 CALibration Subsystem

The commands of the CALibration subsystem determine the data for system error correction in the instrument.

CALibration[:ALL]?

This command initiates the acquisition of system error correction data. A "0" is returned if the acquisition was successful.



During the acquisition of correction data, the instrument does not accept any remote control commands, except

*RST

CALibration:ABORT

In order to recognize when the acquisition of correction data is completed, the MAV bit in the status byte can be used. If the associated bit is set in the Service Request Enable Register, the instrument generates a service request after the acquisition of correction data has been completed.

Example:

```
"*CLS"
'Resets the status management.

"*SRE 16"
'Enables MAV bit in the Service Request Enable Register.

"*CAL?"
'Starts the correction data recording and then a service request is generated.
```

Characteristics: *RST value: -
SCPI: conform

Mode: R, A

CALibration:ABORT

This command aborts the acquisition of correction data and restores the last complete correction data set.

Example: "CAL:ABOR"

Characteristics: *RST value: -
SCPI: device-specific

Mode: R, A

This command is an event and therefore has no *RST value and no query.

CALibration:RESult?

This command outputs the results of the correction data acquisition. The lines of the result table (see chapter “Instrument Functions”, section “Recording the Correction Data – CAL Key” on page 4.113) are output as string data separated by commas:

Return value: "Total Calibration Status: PASSED", "Date (dd/mm/yyyy): 12/07/2006",
"Time: 16:24:54", "Runtime:00.06"

Example: "CAL:RES?"

Characteristics: *RST value: --
SCPI: device-specific

Mode: R, A

CALibration:STATe ON | OFF

This command determines whether the current calibration data are taken into account by the instrument (ON) or not (OFF).

Example: "CAL:STAT OFF"
'Sets up the instrument to ignore the calibration data.

Characteristics: *RST value: -
SCPI: conform

Mode: R, A

6.7 DIAGnostic Subsystem

The DIAGnostic subsystem contains the commands which support instrument diagnostics for maintenance, service and repair. In accordance with the SCPI standard, all of these commands are device-specific.

The measurement windows are selected by DIAGnostic1 (screen A) or DIAGnostic2 (screen B).

DIAGnostic<1|2>:SERVice:INPut[:SELEct] CALibration | RF

This command toggles between the RF input on the front panel and the internal 128 MHz reference signal in the selected measurement window. The level of the 128-MHz signals can be selected by [DIAGnostic<1|2>:SERVice:CSOource\[:POWEr\]](#) command.

Example: "DIAG:SERV:INP CAL"
 ' Selects the internal reference signal.

Characteristics: *RST value: RF
 SCPI: device-specific

Mode: R, A

DIAGnostic<1|2>:SERVice:INPut:PULSed[:STATe] ON | OFF

This command toggles the calibration signal in the selected measurement window between pulsed and non-pulsed.

The selection takes effect only if the RF input has been set to the internal reference signal using the [DIAGnostic<1|2>:SERVice:INPut\[:SELEct\]](#) command.

Example: "DIAG:SERV:INP CAL"
 "DIAG:SERV:INP:PULS ON"

Characteristics: *RST value: OFF
 SCPI: device-specific

Mode: R, A

DIAGnostic<1|2>:SERVice:INPut:PULSed:PRATe 10 kHz | 100 kHz | 200 kHz | 500 kHz | 1 MHz | 2 MHz | 4 MHz | 8 MHz

This command selects the pulse rate for the pulsed calibration signal in the selected measurement window.

Example: "DIAG:SERV:INP:PULS:PRAT 2 MHz"

Characteristics: *RST value: -
 SCPI: device-specific

Mode: R, A

DIAGnostic<1|2>:SERVice:SFUNction '<string>'

This command activates a service function which can be selected by indicating the five parameters: function group number, board number, function number, parameter 1 and parameter 2 (see service manual). The contents of the parameter string is identical to the code to be entered in the data entry field of manual operation.

The entry of a service function is accepted only if the system password Level 1 or Level 2 has been entered previously (command: *SYSTem:SECurity*).

The numeric suffix <1|2> is ignored with this command.



The service functions of the instrument are not identical to those of the FSE family. That is why the remote command differs in syntax and data format.

Example: "DIAG:SERV:SFUN '2.0.2.12.1'"

Characteristics: *RST value: -
SCPI: device-specific

Mode: R, A

DIAGnostic<1|2>:SERVice:NSOource ON | OFF

This command switches the 28 V supply of the noise source at the rear panel on or off.

The numeric suffix <1|2> is ignored with this command.

Example: "DIAG:SERV:NSO ON"

Characteristics: *RST value: OFF
SCPI: device-specific

Mode: R, A

DIAGnostic<1|2>:SERVice:CSOource[:POWer] <numeric_value>

This command switches the level of the 128 MHz reference signal source between 0 dBm and -30 dBm in the selected measurement window.

Example: "DIAG:SERV:CSO 0DBM"

Characteristics: *RST value: -30 dBm
SCPI: device-specific

Mode: R, A

DIAGnostic<1|2>:SERVice:STES:RESult?

This command reads the results of the selftest out of the instrument. The lines of the result table are output as string data separated by commas:

The numeric suffix <1|2> is ignored with this command.

Parameter: "Total Selftest Status: PASSED", "Date (dd/mm/yyyy): 09/07/
2006
TIME: 16:24:54", "Runtime: 00:06", ...

Example: "DIAG:SERV:STES:RES?"

Characteristics: *RST value: --
SCPI: device-specific

Mode: R, A

This command is only a query and therefore has no *RST value.

DIAGnostic<1|2>:SERVICE:HWInfo?

This command queries the contents of the module info table. Table lines are output as string data and are separated by commas.

```
"<component 1>|<serial #>|<order #>|<model>|<HWC>|<rev>|<sub rev>",  
"<component 2>|<serial #>|<order #>|<model>|<HWC>|<rev>|<sub rev>", ...
```

The individual columns of the table are separated from each other by '|'.
The numeric suffix <1|2> is ignored with this command.

Example: "DIAG:SERV:HWInfo?"

Result (shortened):

```
"RF_ATTEN_7|650551/007|1067.7684|02|00|20|04",  
"IF-FILTER|648158/037|1093.5540|03|01|07|05",  
...
```

Characteristics: *RST value: --
SCPI: device-specific

Mode: R, A

6.8 DISPlay Subsystem

The DISPlay subsystem controls the selection and presentation of textual and graphic information as well as of measurement data on the display.

The measurement windows are selected by WINDow1 (screen A) or WINDow2 (screen B).

DISPlay:FORMat SINGLE | SPLit

This command switches the measurement result display between FULL SCREEN and SPLIT SCREEN. The coupling of settings between screen A and screen B can be selected with the command INSTRument:COUPlE.

In full-screen display the active measurement window can be selected with DISPlay:WINDow<1|2>:SElect.

Example: "DISP:FORM SPL"
'Switches the display to 2 measurement windows.

Characteristics: *RST value: SINGLE
SCPI: device-specific

Mode: R, A

DISPlay:ANNotation:FREQuency ON | OFF

This command switches the x-axis annotation on or off.

Example: "DISP:ANN:FREQ OFF"

Characteristics: *RST value: ON
SCPI: conform

Mode: R, A

DISPlay:LOGO ON | OFF

This command switches the company logo on the screen on or off.

Example: "DISP:LOGO OFF"

Characteristics: *RST value: ON
SCPI: device-specific

Mode: R, A

DISPlay:PSAVe[:STATe] ON | OFF

This command switches on or off the power-save mode of the display. With the power-save mode activated the display including backlight is completely switched off after the elapse of the response time (see command DISPlay:PSAVe:HOLDoff).



This mode is recommended for preserving the display especially if the instrument is exclusively operated via remote control.

Example: "DISP:PSAVe ON"
'Switches on the power-save mode.

Characteristics: *RST value: OFF
SCPI: device-specific

Mode: R, A

DISPlay:PSAVe:HOLDoff 1 to 60

This command sets the hold off time for the power-save mode of the display. The available value range is 1 to 60 minutes, the resolution 1 minute. The entry is dimensionless.

Example: "DISP:PSAV:HOLD 30"

Characteristics: *RST value: 15
SCPI: device-specific

Mode: R, A

DISPlay:CMAP<1...34>:DEFault<1|2>

This command resets the screen colors of all display items to their default settings. Two default settings DEFault1 and DEFault2 are available. The numeric suffix of CMAP is irrelevant.

Example: "DISP:CMAP:DEF2"
'Selects default setting 2 for setting the colors.

Characteristics: *RST value: --
SCPI: conform

Mode: R, A

This command is an event and therefore has no query and no *RST value.

DISPlay:CMAP<1...34>:HSL <hue>,<sat>,<lum>

This command defines the color table of the instrument.

Each numeric suffix of CMAP is assigned one or several graphical elements which can be modified by varying the corresponding color setting. The following assignment applies:

CMAP1	Background
CMAP2	Grid
CMAP3	Function field + status field + data entry text
CMAP4	Function field LED on
CMAP5	Function field LED warn
CMAP6	Enhancement label text
CMAP7	Status field background
CMAP8	Trace 1
CMAP9	Trace 2
CMAP10	Trace 3
CMAP11	Marker
CMAP12	Lines
CMAP13	Measurement status + limit check pass
CMAP14	Limit check fail
CMAP15	Table + softkey text
CMAP16	Table + softkey background

CMAP17	Table selected field text
CMAP18	Table selected field background
CMAP19	Table + data entry field opaque title bar
CMAP20	Data entry field opaque text
CMAP21	Data entry field opaque background
CMAP22	3D shade bright part
CMAP23	3D shade dark part
CMAP24	Softkey state on
CMAP25	Softkey state data entry
CMAP26	Logo
CMAP27	Bar graph PK+
CMAP28	Bar graph PK-
CMAP29	Bar graph QPK
CMAP30	Bar graph AVER
CMAP31	Bar graph RMS
CMAP32	Final Meas
CMAP33	Bar graph CACV
CMAP34	Bar graph CRMS

Parameter: hue = TINT
 sat = SATURATION
 lum = BRIGHTNESS
 The value range is 0 to 1 for all parameters.

Example: "DISP:CMAP2:HSL 0.3,0.8,1.0"
 'Changes the grid color.

Characteristics: *RST value: --
 SCPI: conform

Mode: R, A

The values set are not changed by *RST.

DISPlay:CMAP<1...34>:PDEFined BLACK | BLUE | BROWn | GREen | CYAN | RED | MAGenta |
 YELLow | WHITE | DGRAY | LGRAY | LBLUe | LGREen | LCYan | LRED | LMAGenta

This command defines the color table of the instrument using predefined color values. Each numeric suffix of CMAP is assigned one or several graphical elements which can be modified by varying the corresponding color setting.

The same assignment as for DISPlay:CMAP<1 to 26>:HSL applies.

Example: "DISP:CMAP2:PDEF GRE"

Characteristics: *RST value: --
 SCPI: conform

Mode: R, A

The values set are not changed by *RST.

DISPlay[:WINDow<1|2>]:ACTive?

This command returns the active measurement window. The numeric response has following meaning:

- 1 Screen A
- 2 Screen B
- 3 Screen C
- 4 Screen D

Example: "DISP:WIND:ACT?"
returns the active window

Characteristics: *RST value: --
SCPI: device-specific

Mode: R, A

The numeric suffix at WINDow<1|2> is irrelevant.

DISPlay[:WINDow<1|2>]:SElect

This command selects the active measurement window. WINDow1 corresponds to SCREEN A, WINDow2 to SCREEN B.

In full screen mode, the measurements are only performed in the active measurement window. Measurements are therefore initiated in the active window and result queries (marker, trace data and other results) answered also in the active window.

Initiating measurements and querying results in the inactive window yields an error message (execution error).

In split screen mode, the selection of the active window for result queries is irrelevant.



In full screen mode, settings can also be performed in the inactive measurement window. They become effective as soon as the corresponding window becomes active.

Example: "DISP:WIND2:SEL"
'Selects screen B as active measurement window.

Characteristics: *RST value: SCREEN A active
SCPI: device-specific

Mode: R, A

This command is an event and therefore has no query.

DISPlay[:WINDow<1|2>]:SIZE LARGE | SMALL

This command switches the measurement window for channel and adjacent channel power measurements to full screen or half screen. Only "1" is allowed as a numerical suffix.

Example: "DISP:WIND1:SIZE LARG"
'Switches the measurement window to full screen.

Characteristics: *RST value: SMALL
SCPI: device-specific

Mode: A

DISPlay[:WINDow<1|2>]:TEXT[:DATA] <string>

This command defines a comment (max. 20 characters) which can be displayed on the screen in the selected measurement window.

Example: "DISP:WIND2:TEXT 'Noise Measurement'"
 'Defines the title for screen B

Characteristics: *RST value: "" (empty)
 SCPI: conform

Mode: R, A

DISPlay[:WINDow<1|2>]:TEXT:STATe ON | OFF

This command switches on or off the display of the comment (screen title) in the selected measurement window.

Example: "DISP:TEXT:STAT ON"
 'Switches on the title of screen B.

Characteristics: *RST value: OFF
 SCPI: conform

Mode: R, A

DISPlay[:WINDow<1|2>]:TIME ON | OFF

This command switches on or off the screen display of date and time. The numeric suffix in WINDow<1|2> is irrelevant.

Example: "DISP:TIME ON"

Characteristics: *RST value: OFF
 SCPI: device-specific

Mode: R, A

DISPlay[:WINDow<1|2>]:TRACe<1...3>:X:SPACing LINear | LOGarithmic

This command toggles between linear and logarithmic display.

Example: "DISP:TRAC:X:SPAC LIN"

Characteristics: *RST value: LOGarithmic
 SCPI: conform

Mode: R, A

The numeric suffix in TRACe<1...3> is irrelevant.

DISPlay[:WINDow<1|2>]:TRACe<1...3>:X[:SCALE]:ZOOM ON | OFF

This command switches the zoom on or off.

Example: "DISP:TRAC:X:ZOOM ON"

Characteristics: *RST value: OFF
 SCPI: conform

Mode: R, A

The numeric suffix in TRACe<1...3> is irrelevant.

DISPlay[:WINDow<1|2>]:TRACe<1...3>:Y[:SCALe] 10dB to 200dB

This command defines the display range of the y-axis (level axis) in the selected measurement window with logarithmic scaling ([DISPlay\[:WINDow<1|2>\]:TRACe<1...3>:Y:SPACing](#)).

For linear scaling, the display range is fixed and cannot be modified. The numeric suffix at TRACe<1...3> is irrelevant.

Example: "DISP:TRAC:Y 110dB"

Characteristics: *RST value: 100dB
SCPI: device-specific

Mode: R, A

DISPlay[:WINDow<1|2>]:TRACe<1...3>:Y[:SCALe]:MODE ABSolute | RELative

This command defines the scale type of the y-axis (absolute or relative) in the selected measurement window. `SYSTem:DISPlay` is set to `OFF`, this command has no immediate effect on the screen. The numeric suffix in TRACe<1...3> is irrelevant.

Example: "DISP:TRAC:Y:MODE REL"

Characteristics: *RST value: ABS
SCPI: device-specific

Mode: R, A

DISPlay[:WINDow<1|2>]:TRACe<1...3>:Y[:SCALe]:RLEVel -130dBm to 30dBm

This command defines the reference level in the selected measurement window. Depending on the coupling of the measurement windows, it is valid for both screens or only for the selected measurement window ([INSTrument:COUPle](#)). The unit depends on the setting defined with the [CALCulate<1|2>:UNIT:POWer](#) command.

The numeric suffix at TRACe<1...3> is irrelevant.

If the reference level offset is not 0 ([DISPlay\[:WINDow<1|2>\]:TRACe<1...3>:Y\[:SCALe\]:RLEVel:OFFSet](#)), the indicated value range of the reference level is modified by the offset.

Example: "DISP:TRAC:Y:RLEV -60"

Characteristics: *RST value: -20
SCPI: conform

Mode: A

DISPlay[:WINDow<1|2>]:TRACe<1...3>:Y[:SCALe]:RLEVel:OFFSet -200dB to 200dB

This command defines the offset of the reference level in the selected measurement window.

Depending on the coupling of the measurement windows, it is valid for both screens or only for the selected measurement window ([INSTrument:COUPle](#)).

The numeric suffix at TRACe<1...3> is irrelevant.

Example: "DISP:TRAC:Y:RLEV:OFFS -10dB"

Characteristics: *RST value: 0dB
SCPI: conform

Mode: A

DISPlay[:WINDow<1|2>]:TRACe<1...3>:Y[:SCALe]:RVALue <numeric_value>

If the tracking generator option or the external generator control option (R&S FSP-B9/R&S FSP-B10) is available and the normalization in the NETWORK mode is activated, this value defines the power value assigned to the reference position in the selected measurement window. This value corresponds to the parameter REFERENCE VALUE in manual operation.

The numeric suffix at TRACe<1...3> is irrelevant.

Example: "DISP:TRAC:Y:RVAL 0"
'Sets the power value assigned to the reference position to 0 dB (Tracking Generator/Ext. Generator Control option).

Characteristics: *RST value:
0 dB (NETWORK mode)
SCPI: device-specific

Mode: A

DISPlay[:WINDow<1|2>]:TRACe<1...3>:Y[:SCALe]:RPOSition 0 to 100PCT

This command defines the position of the reference value in the selected measurement window. The numeric suffix in TRACe<1...3> is irrelevant.

In NETWORK mode (Tracking Generator/Ext. Generator Option R&S FSP-B9/R&S FSP-B10) with active normalization, RPOSition defines the reference point for the output of the normalized measurement results.

Example: "DISP:TRAC:Y:RPOS 50PCT"

Characteristics: *RST value:
100PCT (ANALYZER mode)
50 PCT (NETWORK mode)
SCPI: conform

Mode: A

DISPlay[:WINDow<1|2>]:TRACe<1...3>:Y[:SCALe]:BOTTom <numeric_value>

In receiver mode, this command defines the minimum grid level in the current unit for the scan display.

The numeric suffix in TRACE<1...3> is irrelevant.

Example: "DISP:TRAC:Y:BOTT -20"
'The minimum grid level is set to -20 dBuV (pre-condition: the default unit has not been changed)

Characteristics: *RST value: 0
SCPI: conform

Mode: R

DISPlay[:WINDow<1|2>]:TRACe<1...3>:Y:SPACing LINear | LOGarithmic| LDB

This command toggles between linear and logarithmic display in the selected measurement window. On a linear scale, switch over between the unit % (command DISP:WIND:TRAC:Y:SPAC LIN) and the unit dB (command DISP:WIND:TRAC:Y:SPAC LDB) is also possible.

If the FM demodulator (R&S FS-K7) is active and result display AF spectrum of FM is selected, only the parameters LINear and LOGarithmic are permissible.

The numeric suffix in TRACe<1...3> is irrelevant.

Example: "DISP:TRAC:Y:SPAC LIN"

Characteristics: *RST value: LOGarithmic
SCPI: conform

Mode: A

DISPlay[:WINDow<1|2>]:TRACe<1...3>:Y:UNIT?

This command returns the Y unit that has been set.

This command is only a query and has the *RST value from the UNIT:POWER command.

The numeric suffix in TRACe<1...3> has no significance.

Example: "DISP:WIND1:TRAC:Y:UNIT?"

Characteristics: *RST value: DBM
SCPI: device-specific

Mode: A

DISPlay[:WINDow<1|2>]:TRACe<1...3>:MODE WRITE | VIEW | AVERAge | MAXHold | MINHold

This command defines the type of display and the evaluation of the traces in the selected measurement window. WRITE corresponds to the Clr/Write mode of manual operation.

The trace is switched off (= BLANK in manual operation) with the [DISPlay\[:WINDow<1|2>\]:TRACe<1...3>\[:STATe\]](#) command.

The number of measurements for AVERAge, MAXHold and MINHold is defined with the [\[SENSe<1|2>\]:JAVERAge:COUNT](#) or [\[SENSe<1|2>\]:JSWEep:COUNT](#) command.

Synchronization to the end of the indicated number of measurements is only possible in single-sweep mode.

If calculation of average values is active, selection between logarithmic and linear averaging is possible. For more detail see command [\[SENSe<1|2>\]:JAVERAge:TYPE](#).

Example:

```
"INIT:CONT OFF"
'Switching to single-sweep mode.

"SWE:COUN 16"
'Sets the number of measurements to 16.

"DISP:WIND1:TRAC3:MODE MAXH"
'Switches on the calculation of the for trace 3 in screen A.

"INIT;*WAI"
'Starts the measurement and waits for the end of the 16 sweeps.
```

Characteristics: *RST value: WRITE for TRACe1, STATe OFF for TRACe2/3
SCPI: device-specific

Mode: R, A

DISPlay[:WINDow<1|2>]:TRACe<1...3>:MODE:HCONtinuous ON | OFF

This command specifies whether or not the traces with peak or minimum value detection are reset after specific parameter changes.

Usually the measurement must be restarted after a parameter change, before an evaluation of the measurement results is performed (e.g. with a marker). In cases in which a change causes a compulsory new measurement, the trace is automatically reset in order to prevent erroneous measurements of previous measurement results (e.g. when the span changes). For applications in which this behavior is not desired, this mechanism can be switched off.

Parameter: OFF: The traces are reset after specific parameter changes.
ON: The reset mechanism is switched off.

Example: "DISP:WIND1:TRAC3:MODE:HCON ON"
'The reset mechanism is switched off for measurement window 1.

Characteristics: *RST value: OFF
SCPI: device-specific

Mode: A

DISPlay[:WINDow<1|2>]:TRACe<1...3>[:STATe] ON | OFF

This command switches on or off the display of the corresponding trace in the selected measurement window.

Example: "DISP:WIND1:TRAC3 ON"

Characteristics: *RST value: ON for TRACe1, OFF for TRACe2 and 3
SCPI: conform

Mode: R, A

DISPlay[:WINDow<1|2>]:TRACe<1...3>:SYMBol CROSSs | OFF

This command switches on or off the indication of the peak list or the final measurement result on the trace.

Parameter: CROSSs: The single value is indicated as x.
OFF: No indication.

Example: "DISP:TRAC:SYMB CROS"

Characteristics: *RST value: OFF
SCPI: device-specific

Mode: R

DISPlay:BARGraph:LEVel:LOWer?

This command queries the minimum level of the bar graph.

Example: ":DISP:BARGraph:LEV:LOW?"

Characteristics: *RST value: --
SCPI: device-specific

Mode: R

DISPlay:BARGraph:LEVel:UPPer?

This command queries the maximum level of the bar graph.

Example: ":DISP:BARGraph:LEV:UPP?"

Characteristics: *RST value: --
SCPI: device-specific

Mode: R

DISPlay:BARGraph:PHOLd ON | OFF

This command switches the indication of the maxhold value of the bar graph measurement on or off.

Example: ":DISP:BARGraph:PHOL ON"

Characteristics: *RST value: OFF
SCPI: device-specific

Mode: R

DISPlay:BARGraph:PHOLd:RESet

This command resets the maxhold value of the numeric indication of the bar graph measurement.

Example: ":DISP:BARGraph:PHOL:RES"

Characteristics: *RST value: --
SCPI: device-specific

Mode: R

This command is an event and thus has no *RST value and no query.

6.9 FORMat Subsystem

The FORMat subsystem specifies the data format of the data transmitted from and to the instrument.

FORMat[:DATA] ASCii | REAL | UINT [, 8 | 32]

This command specifies the data format for the data transmitted from the instrument to the control PC.

The format settings are valid for the binary transmission of trace data (see also [TRACe\[:DATA\]](#)).

Example: "FORM REAL, 32"

"FORM ASC"

"FORM UINT, 8"

Characteristics: *RST value: ASCii
SCPI: conform

Mode: R, A

The data format is either ASCII or one of the formats REAL. ASCII data are transmitted in plain text, separated by commas. REAL data are transmitted as 32-bit IEEE 754 floating-point numbers in the "definite length block format".

The FORMat command is valid for the transmission of trace data and the results of the bar graph measurement. The data format of trace data received by the instrument is automatically recognized, regardless of the format which is programmed.



Incorrect format setting will result in numerical conversion, which may lead to incorrect results.

FORMat:DEXPort:DSEParator POINT | COMMA

This command defines which decimal separator (decimal point or comma) is to be used for outputting measurement data to the file in ASCII format. Different languages of evaluation programs (e.g. Microsoft Excel) can thus be supported.

Example: "FORM:DEXP:DSEP POIN"
'Sets the decimal point as separator.

Characteristics: *RST value: -- (factory setting is POINT; *RST does not affect setting)
SCPI: device-specific

Mode: R, A

6.10 HCOpy Subsystem

The HCOpy subsystem controls the output of display information for documentation purposes on output devices or files. The instrument allows two independent printer configurations which can be set separately with the numeric suffix <1|2>.

HCOpy:ABORt

This command aborts a running hardcopy output.

Example: "HCOP:ABOR"

Characteristics: *RST value: -
SCPI: conform

Mode: R, A

This command is an event and therefore has no *RST value and no query.

HCOpy:CMAP<1...34>:DEFault<1|2|3>

This command resets the colors for a hardcopy to the selected default settings. DEFault1 (SCREEN COLORS, but background white), DEFault2 (OPTIMIZED COLOR SET) and DEFault3 (USER DEFINED). The numeric suffix in CMAP is not significant.

Example: "HCOP:CMAP:DEF2"
'selects OPTIMIZED COLOR SET for the color settings of a hardcopy.

Characteristics: *RST value: --
SCPI: conform

Mode: R, A

This command is an event and therefore has no query and no *RST value.

HCOpy:CMAP<1...34>:HSL <hue>,<sat>,<lum>

This command defines the color table in USER DEFINED COLORS mode.

To each numeric suffix of CMAP is assigned one or several picture elements which can be modified by varying the corresponding color setting. The following assignment applies:

CMAP1	Background
CMAP2	Grid
CMAP3	Function field + status field + data entry text
CMAP4	Function field LED on
CMAP5	Function field LED warn
CMAP6	Enhancement label text
CMAP7	Status field background
CMAP8	Trace 1
CMAP9	Trace 2
CMAP10	Trace 3
CMAP11	Marker
CMAP12	Lines
CMAP13	Measurement status + limit check pass
CMAP14	Limit check fail

CMAP15	Table + softkey background
CMAP16	Table + softkey text
CMAP17	Table selected field text
CMAP18	Table selected field background
CMAP19	Table + data entry field opaque title bar
CMAP20	Data entry field opaque text
CMAP21	Data entry field opaque background
CMAP22	3D shade bright part
CMAP23	3D shade dark part
CMAP24	Softkey state on
CMAP25	Softkey state data entry
CMAP26	Logo
CMAP27	Bar graph PK+
CMAP28	Bar graph PK-
CMAP29	Bar graph QPK
CMAP30	Bar graph AVER
CMAP31	Bar graph RMS
CMAP32	Final Meas
CMAP33	Bar graph CAV
CMAP34	Bar graph CRMS

Parameter: hue = tint
 sat = saturation
 lum = brightness
 The value range is 0 to 1 for all parameters

Example: "HCOPY:CMAP2:HSL 0.3,0.8,1.0"
 'Changes the grid color.

Characteristics: *RST value: --
 SCPI: conform

Mode: R, A

The values set are not changed by *RST.

HCOPY:CMAP<1 to 34>:PDEFined BLACK | BLUE | BROWn | GREen | CYAN | RED | MAGenta |
 YELLow | WHITe | DGRAY | LGRAY | LBLUe | LGREen | LCYan | LRED | LMAGenta

This command defines the color table in USER DEFINED COLORS using predefined color values. To each numeric suffix of CMAP is assigned one or several picture elements which can be modified by varying the corresponding color setting. The same assignment as for :HCOPY:CMAP<1 to 26>:HSL applies

Example: "HCOPY:CMAP2:PDEF GRE"

Characteristics: *RST value: --
 SCPI: conform

Mode: R, A

The values set are not changed by *RST.

HCOPY:DESTination<1|2> <string>

This command selects the printer output medium (Disk, Printer or Clipboard) associated with configuration 1 or 2.



The type of instrument is selected with `SYSTEM:COMMunicate:PRINter:SElect`, which will automatically select a default output medium. Therefore the command `HCOPY:DESTination` should always be sent after setting the device type.

Parameter: <string>::= 'SYST:COMM:GPIB' | 'SYST:COMM:SER' | 'SYST:COMM:CENT' | 'MMEM' | 'SYST:COMM:PRIN' | 'SYST:COMM:CLIP'

'MMEM': Directs the hardcopy to a file. Command `MMEM:NAME '<file_name>'` defines the file name. All formats can be selected for `HCOPY:DEVIce:LANGuage`.

'SYST:COMM:PRIN': Directs the hardcopy to the printer. The printer is selected with command `SYSTEM:COMMunicate:PRINter:SElect`. `GDI` should be selected for `HCOPY:DEVIce:LANGuage`.

'SYST:COMM:CLIP': Directs the hardcopy to the clipboard. `EWMF` should be selected for `HCOPY:DEVIce:LANGuage`.

Example: `"SYST:COMM:PRIN:SEL2 'LASER on LPT1'"`
 'Selects the printer and output medium for device 2

`"HCOP:DEST2 'SYST:COMM:PRIN'"`
 'Selects the printer interface as device 2.

Characteristics: *RST value: -
 SCPI: conform

Mode: R, A

This command is an event and therefore has no *RST value and no query.

HCOPY:DEVIce:COLor ON|OFF

This command selects between color and monochrome hardcopy of the screen.

Example: `"HCOP:DEV:COL ON"`

Characteristics: *RST value: OFF
 SCPI: conform

Mode: R, A

HCOPY:DEVICE:LANGUage<1|2> GDI | WMF | EWMF | BMP

This command determines the data format for the printed output.

Parameter: GDI (Graphics Device Interface): Default format for output to a printer that has been configured under Windows. Must be selected for output to the printer interface (HCOPY:DEVICE 'SYST:COMM:PRIN'). Can be used for output to a file (HCOPY:DEVICE 'SYST:COMM:M MEM'). The printer driver that was configured under Windows is used to generate a file format that is specific to the printer. GDI is available only for H COPY:MODE SCReen.

WMF (WINDOWS Metafile) and EWMF (Enhanced Metafile Format): Data formats for output to files which can be directly processed at a later point in time for documentation purposes using suitable software. WMF can be used only for output to a file (HCOPY:DEVICE 'SYST:COMM:M MEM'), EWMF can also be used for output to the clipboard (HCOPY:DEVICE 'SYST:COMM:CLIP').

BMP (Bitmap): Data format, exclusively for output to files (HCOPY:DEVICE 'SYST:COMM:M MEM').

BMP is available only for H COPY:MODE SCReen.

Example: "HCOP:DEV:LANG WMF"

Characteristics: *RST value: -
SCPI: conform

Mode: R, A

HCOPY[:IMMEDIATE<1|2>]

This command starts a hardcopy output. The numeric suffix selects which printer configuration (1 or 2) is to be used for the hardcopy output. If there is no suffix, configuration 1 is automatically selected.

Example: "HCOP"
"HCOPY:IMM1"
'Starts the hardcopy output to device 1 (default).'
"HCOPY:IMM2"
'Starts the output to device 2.'

Characteristics: *RST value: -
SCPI: conform

Mode: R, A

This command is an event and therefore has no *RST value and no query.

HCOPY:ITEM:ALL

This command selects the complete screen to be output.

The hardcopy output is always provided with comments, title, time and date. As an alternative to the whole screen, only traces (commands 'HCOPY:ITEM:WINDOW:TRACE:STATE ON') or tables (command 'HCOPY:ITEM:WINDOW:TABLE:STATE ON') can be output.

Example: "HCOP:ITEM:ALL"

Characteristics: *RST value: -
SCPI: conform

Mode: R, A

This command is an event and therefore has no *RST value and no query.

HCOPY:ITEM:WINDOW<1|2>:TABLE:STATE ON | OFF

This command selects the output of the currently displayed tables.

Example: "HCOP:ITEM:WIND:TABL:STAT ON"

Characteristics: *RST value: OFF
SCPI: device-specific

Mode: R, A

The command `HCOPY:DEVICE:ITEM:WINDOW<1|2>:TABLE:STATE OFF` as well as command `HCOPY:DEVICE:ITEM:ALL` enables the output of the whole screen.

HCOPY:ITEM:WINDOW<1|2>:TEXT <string>

This command defines the comment text for measurement window 1 or 2 for printout, with a maximum of 100 characters; line feed by means of character @).

Example: "HCOP:ITEM:WIND2:TEXT 'comment'"

Characteristics: *RST value: -
SCPI: device-specific

Mode: R, A

HCOPY:ITEM:WINDOW<1|2>:TRACE:STATE ON | OFF

This command selects the output of the currently displayed trace.

Example: "HCOP:ITEM:WIND:TRACe:STAT ON"

Characteristics: *RST value: OFF
SCPI: device-specific

Mode: R, A

The command `HCOPY:ITEM:WINDOW<1|2>:TRACe:STATE OFF` as well as command `HCOPY:ITEM:ALL` enables the output of the whole screen.

HCOPY:PAGE:ORIENTATION<1|2> LANDscape | PORTRait

The command selects the format of the output (portrait and landscape) (hardcopy unit 1 or 2).



The command is only available provided that the output device "printer" (HCOPY:DEST 'SYST:COMM:PRIN') has been selected.

Example: "HCOPY:PAGE:ORI LAND"

Characteristics: *RST value: -
SCPI: conform

Mode: R, A

6.11 INITiate Subsystem

The INITiate subsystem controls the init measurement function in the selected measurement window. In receiver mode, a distinction is made between single measurement (INITiate1) and scan (INITiate2). In analyzer mode, a distinction is made between INITiate1 (screen A) and INITiate2 (screen B) in split screen representation.

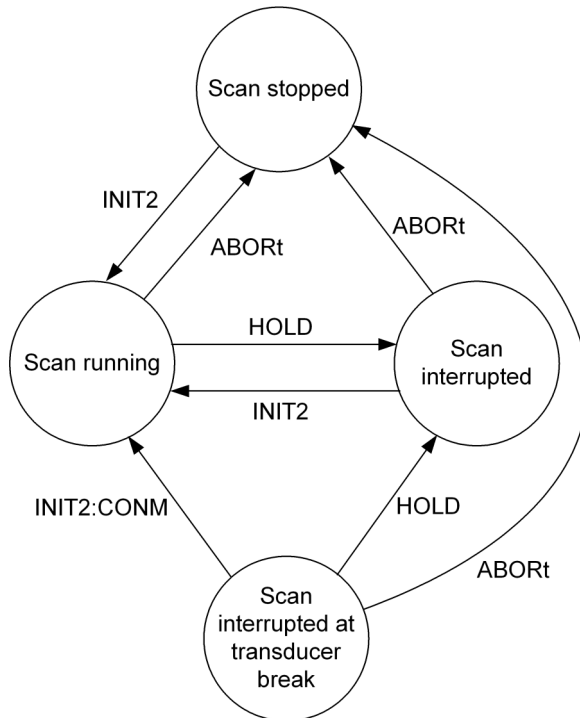

Fig. 6.1 State diagram of the receiver scan

INITiate<1|2>:CONTInuous ON | OFF

This command determines whether the trigger system is continuously initiated (continuous) or performs single measurements (single).

Setting "INITiate:CONTInuous ON" corresponds to function SCAN/SWEEP CONTInuous, i.e. the scan/sweep of the receiver/analyzer is cyclically repeated. The setting "INITiate:CONTInuous OFF" corresponds to function SCAN/SWEEP SINGLE.

Example: "INIT2:CONT OFF"
'Switches the sequence in screen B to single scan/sweep.
"INIT2:CONT ON"
'Switches the sequence to continuous scan/sweep.

Characteristics: *RST value: ON
SCPI: conform

Mode: R, A

INITiate<1|2>:CONMeas

In receiver mode, this command continues a stopped measurement at the current receiver frequency in scan mode, if a scan was interrupted by a transducer stop. If the scan was interrupted with the HOLD command, continue the scan with the command INITiate2:IMMediate.

In analyzer mode, this command continues a stopped measurement at the current position in single-sweep mode. The function is useful especially for trace functions MAXHold, MINHold and AVERage if the previous results are not to be cleared with Sweep Count > 0 or Average Count > 0 on restarting the measurement (INIT:IMMediate resets the previous results on restarting the measurement).

The single-sweep mode is automatically switched on. Synchronization to the end of the indicated number of measurements can then be performed with the command *OPC, *OPC? or *WAI. In the continuous-sweep mode, synchronization to the sweep end is not possible since the overall measurement "never" ends.

Example:

```
"INIT2:CONT OFF"
'Switches to single-sweep mode.

"DISP:WIND:TRAC:MODE AVER
'Switches on trace averaging.

"SWE:COUN 20"
Setting the sweep counter to 20 sweeps.

"INIT2;*WAI"
'Starts the measurement and waits for the end of the 20 sweeps.

"INIT2:CONM;*WAI"
'Continues the measurement (next 20 sequences) and waits for the end.
```

Characteristics: *RST value: -
SCPI: device-specific

Mode: R, A

This command is an event and therefore has no *RST value and no query.

INITiate<1|2>[:IMMediate]

The command initiates a new sweep in the indicated measurement window.

In receiver mode with *SINGLE SCAN* selected, the R&S ESCI performs a single scan and stops at the end frequency. With *CONTINUOUS SCAN* selected, the scan is performed continuously until it is deliberately stopped.

In analyzer mode, with Sweep Count > 0 or Average Count > 0, this means a restart of the indicated number of measurements. With trace functions MAXHold, MINHold and AVERage, the previous results are reset on restarting the measurement.

In single-sweep mode, synchronization to the end of the indicated number of measurements can be achieved with the command *OPC, *OPC? or *WAI. In continuous-sweep mode, synchronization to the sweep end is not possible since the overall measurement never ends.

Example: "INIT2:CONT OFF"
'Switches to single-sweep mode.

"DISP:WIND:TRAC:MODE AVER"
'Switches on trace averaging.

"SWE:COUN 20"
Setting the sweep counter to 20 sweeps.

"INIT2;*WAI"
'Starts the measurement and waits for the end of the 20 sweeps.

Characteristics: *RST value: -
SCPI: conform

Mode: R, A

This command is an event and therefore has no *RST value and no query.

INITiate<1|2>:DISPlay ON | OFF

This command configures the behavior of the display during a single sweep.

The numeric suffix of INITiate is irrelevant with this command.

Parameter: OFF: the display is switched off during the measurement,
ON: the display is switched on during the measurement.

Example: "INIT2:CONT OFF"
'Switches to single-sweep mode

"INIT2:DISP OFF"
'Sets the display behavior to OFF

"INIT2;*WAI"
'Starts the measurement with display switched off.

Characteristics: *RST value: ON
SCPI: device-specific

Mode: A

INITiate<1|2>:ESPectrum

This command starts a Spectrum Emission Mask measurement. The measurement can be stopped in continuous sweep mode with [ABORT](#).

Example: "SENS:SWE:MODE ESP"
' activates the SEM measurement

"INIT:CONT OFF"
' Set to Single Sweep

"INIT:ESP"
' Starts a SEM measurement

Characteristics: *RST value:-
SCPI: device-specific

Mode: A

INITiate<1|2>:FMEasurement

In receiver mode, this command starts a final measurement sequence.

Example: "INIT2:FME" 'Starts the final measurement

Characteristics: *RST value: -
 SCPI: device-specific

Mode: R

This command is an event, so it has neither an *RST value nor a query function.

INITiate<1|2>:EMItest

In receiver mode, this command starts an automatic sequence consisting of the preliminary measurement, determination of the peak list and subsequent final measurement.

Example: "INIT2:EMI"
 'Starts the sequence preliminary measurement, peak search and final measurement

Characteristics: *RST value: -
 SCPI: device-specific

Mode: R

This command is an event, so it has neither an *RST value nor a query function.

INITiate<1|2>:SPURious

This command starts a new spurious measurement.

Example: "INIT:CONT OFF"
 'switches to single-sweep mode

 "INIT:SPUR;*WAI"
 'starts the measurement by waiting for the end of the 20 measurements

Characteristics: *RST value: -
 SCPI: device-specific

Mode: A

6.12 INPut Subsystem

The INPut subsystem controls the input characteristics of the RF inputs of the instrument. In receiver mode, the suffix is irrelevant. In analyzer mode, the measurement windows are assigned to INPut1 (screen A) and INPut2 (screen B).

INPut<1|2>:ATTenuation 0 to 75 dB

This command programs the input attenuator. To protect the input mixer against damage from overloads, the setting 0 dB can be obtained by entering numerals, not by using the command DEC.

The step width is 5 dB, the range is 0 dB to..75 dB.

In analyzer mode, the attenuation set on the step attenuator is coupled to the reference level of the instrument. If the attenuation is programmed directly, the coupling to the reference level is switched off.

In receiver mode, if the attenuation is programmed directly, the auto range function is switched off if necessary. Setting 0 dB can be prevented by activating the protection function (INPut:ATTenuation:PROTection ON).

Characteristics: *RST value: 10 dB (AUTO is set to ON)
SCPI: conform

Mode: R, A

INPut<1|2>:ATTenuation:AUTO ON | OFF

In analyzer mode, this command automatically couples the input attenuation to the reference level (state ON) or switches the input attenuation to manual entry (state OFF). The minimum input attenuation set with the coupling switched on is 10 dB.

In receiver mode, this command automatically sets the attenuation so that a good S/N ratio is obtained without the receiver stages being overdriven (state ON).

Example: "INP:ATT:AUTO ON"
'Switches the auto ranging function on.

Characteristics: *RST value: ON
SCPI: conform

Mode: R, A

INPut<1|2>:ATTenuation:PROTection[:STATe] ON | OFF

This command defines whether the 0 dB position of the attenuator is to be used in manual or automatic adjustment.

Example: "INP:ATT:PROT ON"

Characteristics: *RST value: OFF
SCPI: device-specific

Mode: R

INPut<1|2>:GAIN:STATe ON | OFF

This command switches the preamplifier for the instrument on or off. The switchable gain is fixed to 20 dB.

In analyzer mode, the command is only available, if the preselector measurement has been activated.

Example: "INP:GAIN:STAT ON"
'Switches the 20 dB preamplifier on.

Characteristics: *RST value: OFF
SCPI: conform

Mode: R, A

INPut<1|2>:GAIN:AUTO ON | OFF

This command includes the preamplifier into the autoranging function of the R&S ESCI.

Example: ":INP:GAIN:AUTO ON"
'Includes the preamplifier into the auto range function

Characteristics: *RST value: OFF
SCPI: conform

Mode: R

INPut<1|2>:LISN[:TYPE] TWOPhase | FOURphase | ESH3Z5 | ESH2Z5 | ENV4200 | ENV216 | OFF

This command selects the V-network that is controlled via the USER port. In receiver mode, this setting is used also for the preliminary measurement.

TWOPhase and ESH3Z5	R&S ESH3-Z5 (two phases and protective earth are controllable)
FOURphase and ESH2Z5	R&S ESH2-Z5 (four phases and protective earth are controllable)
ENV4200	R&S ENV 4200 (four phases are controllable)
ENV216	R&S ENV 216 (two phases and highpass are controllable)
OFF	Remote control deactivated

Example: ":INP:LISN:TWOP"

Characteristics: *RST value: OFF
SCPI: device-specific

Mode: R, A

INPut<1|2>:LISN:PHASe L1 | L2 | L3 | N

This command selects the phase of the V-network that is used and which is controlled via the USER port. In receiver mode, this setting is used also for the preliminary measurement. The permissible selection depends on the selected V-network.

Example: ":INP:LISN:PHAS L1"

Characteristics: *RST value: L1
SCPI: device-specific

Mode: R, A

INPut<1|2>:LISN:PEARth GROunded | FLOating

This command selects the setting of the Protective EARth that is controlled via the USER port. In receiver mode, this setting is used also for the preliminary measurement. The availability depends on the selected V-network.

Example: ":INP:LISN:PEAR GRO"

Characteristics: *RST value: GROunded
SCPI: device-specific

Mode: R, A

INPut<1|2>:LISN:FILTer:HPAS[:STATe] ON | OFF

This command selects the setting for the highpass on the V-network that is controlled via the USER port. In receiver mode, this setting is used also for the preliminary measurement. This command is available only for the R&S ENV 216 V-network (INP:LISN ENV216).

Example: ":INP:LISN:FILT:HPAS ON"

Characteristics: *RST value: OFF
SCPI: device-specific

Mode: R

INPut<1|2>:IMPedance 50 | 75

This command sets the nominal input impedance of the instrument. The set impedance is taken into account in all level indications of results.

The setting 75 Ω should be selected, if the 50 Ω input impedance is transformed to a higher impedance using a 75 Ω adapter of the RAZ type (= 25 Ω in series to the input impedance of the instrument). The correction value in this case is 1.76 dB = 10 log (75 Ω / 50 Ω).

Example: ":INP:IMP 75"

Characteristics: *RST value: 50 Ω
SCPI: conform

Mode: R, A

INPut<1|2>:PRESelection[:STATe] ON | OFF

In analyzer mode, this command switches the preselection on or off.



In receiver mode, the preselection is always switched on and cannot be switched off.

Example: ":INP:PRE:STAT ON"

Characteristics: *RST value: OFF
SCPI: device-specific

Mode: A

INPut<1|2>:UPORt[:VALue]?

This command queries the control lines of the user ports.

Example: ":INP:UPOR?"

Characteristics: *RST value: -
SCPI: device-specific

Mode: R, A

This command is a query and therefore has no *RST value.

INPut<1|2>:UPORt:STATe ON | OFF

This command toggles the control lines of the user ports between INPut and OUTPut.

Example: "INP:UPOR:STAT ON"

Characteristics: *RST value: ON
SCPI: device-specific

Mode: R, A

With ON, the user port is switched to INPut, with OFF to OUTPut.

6.13 INSTrument Subsystem

The INSTrument subsystem selects the operating mode of the unit either via text parameters or fixed numbers. Only operating modes available for the base unit and the models and the options described in this manual (see “[Documentation Overview](#)” on page 0.2) are listed. For details on the other operating modes refer to the corresponding separate manuals.

INSTrument[:SElect] SANalyzer | RECeiver | ADEMod

This command enables you to switch between modes by entering the mode designation.

Parameter: SANalyzer: spectrum analyzer
RECeiver: Receiver mode
ADEMod: FM demodulator

Example: "INST SAN"
'Switches the instrument to *SPECTRUM*.

Characteristics: *RST value: RECeiver
SCPI: conform

Mode: R, A



A changeover to a mode other than SANalyzer and RECeiver is only possible if the corresponding option is installed.

INSTrument:NSElect <numeric value>

This command enables you to switch between the modes by using numbers.

Parameter: 1: Analyzer mode
3: FM demodulator mode
6: Receiver mode

Example: "INST:NSEL 1"
'Switches to the analyzer mode.

Characteristics: *RST value: 6
SCPI: conform

Mode: R, A



A changeover to a mode is only possible if the corresponding option is installed.

INSTrument:CONFIgure<1|2>:DISPly SANalyzer | RECeiver

This command selects the combination to be displayed in the mixed mode (INSTrument:CONFIgure:MIXed ON).

Two combinations are available:

Screen 1 (top):	Screen 2 (bottom):
BARgraph	Sweep
Sweep	SCAN

Sweep corresponds to the parameter SANalyzer and bargraph an scan to the parameter RECeiver.

If, for example, INST:CONF1 SAN is used to set the spectrum analyzer for screen 1, the scan display is automatically selected for screen 2 – which is equivalent to INST:CONF2 REC. The same applies conversely, allowing the desired display to be set using only one command.

Example: "INST:CONF:DISP REC"

Characteristics: *RST value:REC
SCPI:device-specific

Mode: R, A

INSTrument:CONFIgure<1|2>:MIXed ON | OFF

This command splits the screen and decouples the two subscreens, permitting a mixed analyzer/receiver display.

Two combinations are available:

Screen 1 (top):	Screen 2 (bottom):
BARgraph	Sweep
Sweep	SCAN

The screens are selected with the following command:

```
INSTrument:CONFIgure:DISPly SANalyzer | RECeiver
```

Example: "INST:CONF:MIX ON"

Characteristics: *RST value:ON
SCPI:device-specific

Mode: R, A

INSTrument:COUPlE NONE | RLEVel | CF_B | CF_A

In analyzer mode, this command selects the parameter coupling between the two measurement windows screen A and B.

Parameter: NONE: No coupling. The two measurement windows are operated like two independent "virtual" devices.

RLEVel: The reference levels of the two measurement windows are coupled.

CF_B: The center frequency of screen B is coupled to the frequency of marker 1 in screen A.

CF_A: The center frequency of screen A is coupled to the frequency of marker 1 in screen B.

Example: "INST:COUP NONE"
 'Switches off the coupling of measurement windows. This leads to two independent "virtual" devices.

Characteristics: *RST value: NONE
 SCPI: device-specific

Mode: A

INSTrument:COUPlE:ATTenuation ALL | NONE

This command couples the RF attenuation settings for the analyzer and receiver modes with one another.

The RF attenuation unit and level unit are then set to the same value in the analyzer and receiver screen.

Example: "INST:COUP:ATT ALL"

Characteristics: *RST value:ALL
 SCPI:device-specific

Mode: R, A

INSTrument:COUPlE:BANDwidth|BWIDth ALL | NONE

This command couples the bandwidth settings for the analyzer and receiver modes with one another.

The resolution bandwidth (RBW) and filter type are then set to the same value on the analyzer and receiver screen. In some cases, other settings (e.g. the quasipeak detector) can block these settings.

Example: "INST:COUP:BWID ALL"

Characteristics: *RST value:NONE
 SCPI:device-specific

Mode: R, A

INSTrument:COUPlE:CENTer ALL | NONE

This command couples the center frequency and receive frequency settings for the analyzer and receiver modes with one another.

Example: "INST:COUP:CENT ALL"

Characteristics: *RST value:ALL
 SCPI:device-specific

Mode: R, A

INSTrument:COUPlE:DEModulation ALL | NONE

This command couples the settings of the audio demodulator for the analyzer and receiver modes with one another.

Example: "INST:COUP:DEM ALL"

Characteristics: *RST value:NONE
 SCPI:device-specific

Mode: R, A

INSTrument:COUPlE:GAIN ALL | NONE

This command couples gain settings for the analyzer and receiver modes with one another.

Example: "INST:COUP:GAIN ALL"

Characteristics: *RST value:ALL
SCPI:device-specific

Mode: R, A

INSTrument:COUPlE:MARKer ALL | NONE

This command couples the frequency of the marker in spectrum analyzer mode to the receive frequency in receiver mode

Example: "INST:COUP:MARK ALL"

Characteristics: *RST value: NONE
SCPI: device-specific

Mode: R, A

INSTrument:COUPlE:PRESelector ALL | NONE

This command couples the activation of the preselector for the analyzer and receiver modes with one another.

In receiver mode, the preselector cannot be deactivated. In normal operation, this means that the preselector is always automatically activated when a change to the analyzer mode occurs and coupling has been activated.

Example: "INST:COUP:PRES ALL"

Characteristics: *RST value:ALL
SCPI:device-specific

Mode: R, A

INSTrument:COUPlE:PROTection ALL | NONE

This command couples the RF protection attenuation of 10 dB for the analyzer and receiver modes with one another.

To prevent damage to the RF input, activate this coupling.

Example: "INST:COUP:PROT ALL"

Characteristics: *RST value:ALL
SCPI:device-specific

Mode: R, A

INSTrument:COUPle:SPAN ALL | NONE

This command couples the start and stop frequencies of sweep and scan for the analyzer and receiver modes with one another.

Example: "INST:COUP:SPAN ALL"

Characteristics: *RST value:NONE
SCPI:device-specific

Mode: R, A

6.14 MMEMory Subsystem

The MMEMory (mass memory) subsystem provides commands which allow for access to the storage media of the instrument and for storing and loading various instrument settings.

The various drives can be addressed via the "mass storage unit specifier" <msus> using the conventional DOS syntax. The internal hard disk is addressed by "D:", the floppy disk drive by "A:" and a memory stick by "F:".

Note that the floppy drive is not integrated in the R&S ESCI7.

The various drives can be addressed via the "mass storage unit specifier" <msus> using the conventional DOS syntax. The internal hard disk is addressed by "D:", the flash disk by "F:".



For reasons of compatibility with the FSE/ESIB instruments, addressing the hard disk by "C:" is also accepted. Since hard disk "C:" is reserved for instrument software, all read and write operations are rerouted to hard disk "D:" in normal operation (service level 0).

The file names <file_name> are indicated as string parameters with the commands being enclosed in quotation marks. They also comply with DOS conventions.

DOS file names consist of max. 8 ASCII characters and an extension of up to three characters separated from the file name by a dot "." Both, the dot and the extension are optional. The dot is not part of the file name. DOS file names do not distinguish between uppercase and lowercase notation. All letters and digits are permitted as well as the special characters "_", "^", "\$", "~", "!", "#", "%", "&", "-", "{", "}", "(", ")", "@", and "'". Reserved file names are CLOCK\$, CON, AUX, COM1 to COM4, LPT1 to LPT3, NUL and PRN.

The two characters "*" and "?" have the function of so-called "wildcards", i.e., they are variables for selection of several files. The question mark "?" replaces exactly one character, the asterisk means any of the remaining characters in the file name. "*.*" thus means all files in a directory.

MMEMory:CATalog? <path>

This command reads the indicated directory. According to DOS convention, wild card characters can be entered in order to query e.g. a list of all files of a certain type.

The path name should be in conformance with DOS conventions and may also include the drive name.

Parameter: <path>::= DOS Path name

Example:

```
"MMEM:CAT? 'D:\USER\DATA'"
'Returns the contents of the D:\USER\DATA directory

"MMEM:CAT? 'D:\USER\DATA\*.LOG'"
'Returns all files in D:\USER\DATA with .LOG extension

"MMEM:CAT? 'D:\USER\DATA\SPOOL?.WMF'"
'Returns all files in D:\USER\DATA whose names start with SPOOL, have 6 letters
and the .WMF extension .
```

Return value: List of file names in the form of strings separated by commas, i.e.
'SPOOL1.WMF', 'SPOOL2.WMF', 'SPOOL3.WMF'

Characteristics: *RST value: -
SCPI: conform

Mode: R, A

MMEMory:CATalog:LONG? <path>

This command queries the directories and files in the given path.

Parameter: <path> ::= DOS path

Example: "MMEM:CAT:LONG? 'D:\USER\DATA'"
'queries the contents of directory D:\USER\DATA

Return value: <used_bytes_in_this_directory>,<free_bytes_on_this_disk>,
"<file_name>,<file_type>,<filesize_in_bytes>","
"<file_name>,<file_type>,<filesize_in_bytes>"," ...

with

<file_name>: name of file or directory

<file_type>: DIR (directory), ASCii (ASCII file), BINary (binary file) and STATe (file with device settings)

<filesize_in_bytes>: size of file, 0 for directories

Characteristics: *RST value: -
SCPI: conform

Mode: R, A

MMEMory:CDIRectory <directory_name>

This command changes the current directory.

In addition to the path name, the indication of the directory may contain the drive name. The path name complies with the DOS conventions.

Parameter: <directory_name> ::= DOS path name

Example: "MMEM:CDIR 'D:\USER\DATA'"
'Returns the list of files in directory D:\USER\DATA.

Characteristics: *RST value: -
SCPI: conform

Mode: R, A

MMEMory:CLEar:STATe 1,<file_name>

This command deletes the instrument setting selected by <file_name>. All associated files on the mass memory storage are cleared. A list of the extensions used is included under MMEMory:LOAD:STATe.

The file name includes indication of the path and may also include the drive. The path name complies with DOS conventions.

Parameter: <file_name> ::= DOS file name without extension

Example: "MMEM:CLE:STAT 1, 'TEST'"

Characteristics: *RST value: -
SCPI: device-specific

Mode: R, A

This command is an event and therefore has no *RST value and no query.

MMEMory:CLEar:ALL

This command deletes all device settings in the current directory. The current directory can be selected with `MMEM:CDIR`. The default directory is D:.

Example: `"MMEM:CLEAR:ALL"`

Characteristics: *RST value: -
SCPI: device-specific

Mode: R, A

This command is an event and therefore has no *RST value and no query.

MMEMory:COMMent <string>

This command defines a comment (max. 60 characters) for a device setting to be stored.

Example: `"MMEM:COMM 'Setup for FM measurement'"`

Characteristics: *RST value: blank comment
SCPI: device-specific

Mode: R, A

MMEMory:COpy <file_source>,<file_destination>

This command copies the files indicated in <file_source> to the destination directory indicated with <file_destination> or to the destination file indicated by <file_destination> when <file_source> is just a file.

The indication of the file name may include the path and the drive name. The file names and path information must be in accordance with the DOS conventions.

Parameter: <file_source>,<file_destination> ::= <file_name>
<file_name> ::= DOS file name

Example: `"MMEM:COPY 'D:\USER\DATA\SETUP.CFG', 'A:'"`

Characteristics: *RST value: -
SCPI: conform

Mode: R, A

This command is an event and therefore has no *RST value and no query.

MMEMory:DATA <file_name>[,<block data>]

This command writes the block data contained in <block> into the file characterized by <file_name>. The GPIB delimiter must be set to EOI to obtain error-free data transfer.

The associated query command reads the indicated file from the mass memory and transfers it to the control computer via the GPIB. It should be noted that the buffer memory of the control computer should be large enough to store the file. The setting of the GPIB delimiter is irrelevant in this case.

The command is useful for reading stored device settings or trace data from the instrument or for transferring them to the instrument.

- `MMEMory:DATA <file_name>,<block data>`
Data transfer from control computer to instrument.
- `MMEMory:DATA? <file_name>`
Data transfer from instrument to control computer.

<file_name> selects the file to be transferred.

The binary data block <block> has the following structure:

- it always begins with the character '#',
- followed by a digit for the length of the length information,
- followed by the indicated number of digits as length information (number of bytes) for the binary data themselves,
- finally the binary data with the indicated number of bytes

Example: "MMEM:DATA 'TEST01.HCP',#216This is the file"
 'means:
 '#2: the next 2 characters are the length indication
 '16: number of subsequent binary data bytes
 'This is the file: 16 bytes stored as binary data in the file TEST01.HCP.
 "MMEM:DATA? 'TEST01.HCP'"
 'Transfers the file TEST01.HCP from the instrument to the control computer.

Characteristics: *RST value: -
 SCPI: conform

Mode: R, A

MMEMory:DELeTe <file_name>

This command deletes the indicated files.

The indication of the file name contains the path and, optionally, the drive name. Indication of the path complies with DOS conventions.

Parameter: <file_name> ::= DOS file name

Example: "MMEM:DEL 'TEST01.HCP'"
 'The file TEST01.HCP is deleted.

Characteristics: *RST value: -
 SCPI: conform

Mode: R, A

This command is an event and therefore has no *RST value and no query.

MMEMory:INITialize <msus>

This command formats the disk in drive A. Formatting deletes all data stored on the disk.

Parameter: <msus> ::= 'A.'
 Only drive name A: is accepted.

Example: "MMEM:INIT 'A: '"

Characteristics: *RST value: -
 SCPI: conform

Mode: A

This command is an event and therefore has no *RST value and no query.

MMEMory:LOAD:AUTO 1,<file_name>

This command defines which device setting is automatically loaded after the device is switched on. The contents of the file are read after switching on the device and used to define the new device state. The file name includes indication of the path and may also include the drive. The path name complies with DOS conventions.



The data set defined as auto recall set will also be restored by a *RST-command.

Parameter: <file_name> ::= DOS file name without extension;
FACTORY denotes the data set previously in the instrument

Example: "MMEM:LOAD:AUTO 1, 'D:\USER\DATA\TEST'"

Characteristics: *RST value: FACTORY
SCPI: device-specific

Mode: R, A

This command is an event and therefore has no *RST value and no query.

MMEMory:LOAD:STATE 1,<file_name>

This command loads device settings from data set files (*.FSP). The contents of the file are loaded and set as the new device state. Items can be individually deselected for the recall. The maximum items to be loaded are the maximum number of items stored in the data set file. If items were deselected for storage, those items cannot be recalled.

The file name includes indication of the path and may also include the drive name. The default path for data set files is D:\USER\CONFIG.

Parameter: <file_name> ::= DOS file name without extension

Example: "MMEM:LOAD:STAT 1, 'A:TEST'"

Characteristics: *RST value: -
SCPI: conform

Mode: R, A

This command is an event and therefore has no *RST value and no query.

MMEMory:MDIRectory <directory_name>

This command creates a new directory. The file name includes indication of the path and may also include the drive name. The path name complies with DOS conventions.

Parameter: <directory_name> ::= DOS path name

Example: "MMEM:MDIR 'D:\USER\DATA'"

Characteristics: *RST value: -
SCPI: device-specific

Mode: R, A

This command is an event and therefore has no *RST value and no query.

MMEMory:MOVE <file_source>,<file_destination>

This command renames existing files, if <file_destination> contains no path indication. Otherwise the file is moved to the indicated path and stored under the file name specified there, if any.

The file name includes indication of the path and may also include the drive. The path name complies with DOS conventions.

Parameter: <file_source>,<file_destination> ::= <file_name>
<file_name> ::= DOS file name

Example: "MMEM:MOVE 'D:\TEST01.CFG', 'SETUP.CFG'"
'Renames TEST01.CFG in SETUP.CFG in directory D:\.

"MMEM:MOVE 'D:\TEST01.CFG', 'D:\USER\DATA'"
'Moves TEST01.CFG from D:\ to D:\USER\DATA.

"MMEM:MOVE 'D:\TEST01.CFG', 'D:\USER\DATA\SETUP.CFG'"
'Moves TEST01.CFG from D:\ to D:\USER\DATA and renames the file in SETUP.CFG.

Characteristics: *RST value: -
SCPI: conform

Mode: R, A

This command is an event and therefore has no *RST value and no query.

MMEMory:MSIS <device>

This command changes to the drive indicated. The drive may be the internal hard disk "D:", a memory stick or the floppy disk drive "A:".

Characteristics: *RST value: "D:"
SCPI: conform

Mode: R, A

MMEMory:NAME <file_name>

This command defines a destination file for the printout started with the command `HCOPY:IMMEDIATE`. In this case the printer output must be routed to destination *FILE* using the command `"HCOP:DEST 'MMEM' "`.

The file name includes indication of the path and may also include the drive name. The file name and path information comply with DOS conventions.

Parameter: <file_name> ::= DOS file name

Example: "HCOP:DEV:LANG BMP"
'Selection of data format.

"HCOP:DEST 'MMEM' "
'Selection of the output device

"MMEM:NAME 'PRINT1.BMP' "
'Selection of file name.

"HCOP:IMM"
'Start of the printout.

Characteristics: *RST value: -
SCPI: conform

Mode: R, A

This command is an event and therefore has no *RST value and no query.

MMEMory:RDIRECTory <directory_name>

This command deletes the indicated directory. The directory name includes indication of the path and may also include the drive name. The path name complies with DOS conventions.

Parameter: <directory_name>::= DOS path name

Example: "MMEM:RDIR 'D:\TEST'"

Characteristics: *RST value: -
SCPI: device-specific

Mode: R, A

This command is an event and therefore has no *RST value and no query.

MMEMory:SElect[:ITEM]:ALL

This command includes all data subsets in the list device settings to be stored/loaded.

Example: "MMEM:SEL:ALL"

Characteristics: *RST value: --
SCPI: device-specific

Mode: R, A

This command is an event and therefore has no *RST value.

MMEMory:SElect[:ITEM]:CLISt ON | OFF

This command includes the scan channel list to be stored/loaded.

Example: "MMEM:SEL:CLIS ON"
'inserts the scan channel list to the list of partial data sets

Characteristics: *RST value: OFF
SCPI: device-specific

Mode: R, A

MMEMory:SElect[:ITEM]:DEFault

This command sets the default list of device settings to be stored/loaded. The latter includes:

- current configuration of general device parameters (general setup)
- current setting of the measurement hardware including markers
- activated limit lines
- user-defined color setting
- configuration for the hardcopy output
- activated transducers
- Tracking generator settings
(only in conjunction with option Tracking Generator B9 or External Generator Control B10)
- Correction data for source calibration
(only in conjunction with option Tracking Generator B9 or External Generator Control B10)

Trace data, non-used transducer factors/sets and non-used limit lines are not included.

Example: "MMEM:SEL:DEF"

Characteristics: *RST value: --
SCPI: device-specific

Mode: R, A

This command is an event and therefore has no *RST value.

MMEMory:SElect[:ITEM]:HWSettings ON | OFF

This command includes the hardware settings in the list of data subsets of a device setting to be stored/loaded. The hardware settings include:

- current configuration of general device parameters (general setup)
- current setting of the measurement hardware including markers
- activated limit lines:
A data set may include 8 limit lines at maximum in each measurement window. This number includes the activated limit lines and, if available, the de-activated limit lines last used. Therefore the combination of the non-activated restored limit lines depends on the sequence of use with the command `MMEM:LOAD`.
- user-defined color setting
- configuration for the hardcopy output
- the activated transducers:
A data set may include 4 transducer factors at maximum. It comprises the activated factors and, if available, the de-activated factors last used. Therefore the combination of non-activated restored transducer factors depends on the sequence of use with the command `MMEM:LOAD`.
- Tracking generator settings
(only in conjunction with option Tracking Generator B9 or External Generator Control B10)
- Correction data for source calibration
(only in conjunction with option Tracking Generator B9 or External Generator Control B10)

Example: "MMEM:SEL:HWS ON"

Characteristics: *RST value: ON
SCPI: device-specific

Mode: R, A

MMEMory:SElect[:ITEM]:LINES:ALL ON | OFF

This command adds all limit lines (activated and de-activated) to the list of device settings to be stored/loaded.

Example: "MMEM:SEL:LIN:ALL ON"

Characteristics: *RST value: ON
SCPI: device-specific

Mode: R, A

MMEMory:SElect[:ITEM]:FINal ON | OFF

This command includes the final measurement data in the list of partial datasets of a device setting to be stored/loaded.

Example: "MMEM:SEL:FIN ON"
'inserts the final measurement data in the list of partial data sets

Characteristics: *RST value: ON
SCPI: device-specific

Mode: R, A

MMEMory:SElect[:ITEM]:NONE

This command deletes all data subsets from the list of device settings to be stored/loaded.

Example: "MMEM:SEL:NONE"

Characteristics: *RST value: --
SCPI: device-specific

Mode: R, A

This command is an event and therefore has no *RST value.

MMEMory:SElect[:ITEM]:SCData ON | OFF

This command adds the tracking generator calibration data to the list of device settings to be stored/loaded.

Example: "MMEM:SEL:SCD ON"
'Inserts the tracking generator correction data in the list of data subsets

Characteristics: *RST value: OFF
SCPI: device-specific

Mode: R, A

This command is only available in conjunction with the tracking generator option B9 or external generator control option B10.

MMEMory:SElect[:ITEM]:TRACe[:ACTive] ON | OFF

This command adds the active traces to the list of data subsets of a save/recall device setting. Active traces are all traces whose state is not blank.

Example: "MMEM:SEL:TRAC ON"

Characteristics: *RST value: OFF, i.e. no traces will be stored
SCPI: device-specific

Mode: R, A

MMEMory:SElect[:ITEM]:TRANsducer:ALL ON | OFF

This command includes all transducer factors and sets in the list of data subsets of a device setting to be stored/loaded.

Example: "MMEM:SEL:TRAN:ALL ON"

Characteristics: *RST value: ON
SCPI: device-specific

Mode: R, A

MMEMory:STORe:FINal <file_name>

This command stores the final measurement data in an ASCII file.

The file name includes indication of the path and may also include the drive. The path name corresponds to the DOS conventions.

Parameter: <file_name> := DOS file name

Example: " :MMEM:STOR:FIN 'A:\TEST.ASC' "

Characteristics: *RST value: -
SCPI: device-specific

Mode: R

This command is an event and therefore has no *RST value and no query.

MMEMory:STORe<1|2>:MARKer <file_name>

This command saves the data of all active markers to a file < file_name >.

Example: "MMEM:STOR:MARK 'C:\marker.txt' "
'Generates a *MARKER.TXT* file that contains all data of the active markers in screen A.
If in screen A two markers are active, the generated *MARKER.TXT* file includes the following:
Marker;1;T1
-25.87;dBm
19.920000000;GHz
Delta;2;T1
-21.90;dB
-5.920000000;GHz

Characteristics: *RST value: --
SCPI: device-specific

Mode: A

The command is an event and therefore has no *RST value and no query.

MMEMory:STORe<1|2>:PEAKlist <file_name>

This command stores the content of the marker peak list in ASCII format to the specified file.

Parameter: <file_name> := DOS file name

Example: "MMEM:STOR:PEAK 'D:\TEST.ASC' "

Characteristics: *RST value: -
SCPI: device-specific

Mode: R, A

MMEMory:STORe<1|2>:SPURious <file_name>

This command stores the peak list in an ASCII file to a file on a disk.

The file has a header containing important parameters for scaling, several data sections containing the sweep settings per range and a data section containing the peak list.

The header data is made up of three columns, separated by ';':

parameter name; numeric value; base unit

The data section for the measurement values starts with the key word "TRACE <n>:", where <n> includes the number of the used trace. Next comes the peak list with several columns also separated by ';':

Spreadsheet programs such as MS Excel can read this format. Use ';' as the delimiter for the table cells.



Different language versions of evaluation programs may require different handling of the decimal point. Using the *DECIM SEP* softkey, you can thus choose between the delimiters '.' (decimal point) and ',' (comma).

Parameter: <file_name> := DOS file name

Example: "MMEM:STOR:SPUR 'D:\TEST.ASC'"

Characteristics: *RST value: -
SCPI: device-specific

Mode: A

This command is an event and therefore has no *RST value and no query.

MMEMory:STORe<1|2>:STATe 1,<file_name>

This command stores the current device settings in a specified file name.

The file name includes indication of the path and may also include the drive name. The numeric suffix in STORe<1|2> is irrelevant with this command.

For a detailed discription of the selectable items refer to the command "[MMEMory:SElect\[:ITEM\]:ALL](#)" on page 6.139.

Parameter: <file_name> = DOS file name without extension

Example: "MMEM:STOR:STAT 1, 'TEST'"

Characteristics: *RST value: -
SCPI: conform

Mode: R, A

This command is an event and therefore has no *RST value and no query.

MMEMory:STORe<1|2>:TRACe 1 to 3,<file_name>

This command stores the selected trace in a file with ASCII format. The file format is described in chapter "[Instrument Functions](#)", section "[ASCII FILE EXPORT](#)" on page 4.106.

The numeric suffix at STORe<1|2> indicates the measurement window (screen A or B).

The decimal separator (decimal point or comma) for floating-point numerals contained in the file is defined with the `FORMat:DEXPort:DSEPARATOR` command.

Parameter: 1 to 3 := selected measurement curve (trace)
 <file_name> := file name in compliance to DOS conventions, including indication of the path and the drive name

Example: "MMEM:STOR2:TRAC 3, 'A:\TEST.ASC'"
 'Stores trace 3 from screen B in the file TEST.ASC on a disk.

Characteristics: *RST value: -
 SCPI: device-specific

Mode: R, A

This command is an event and therefore has no *RST value and no query.

For Spurious Measurement an extended file format is used:

	File contents	Explanation
File header	Type;R&S ESCI;	Model
	Version;3.9x;	Firmware version
	Date;02.Feb 2007;	Storage date of data set
	Mode;ANALYZER;SPURIOUS;	Operating mode of the device Format for Spurious Emissions measurement
	Start;9000.000000;Hz Stop;8000000000.000000;Hz	Start/stop of the span Unit: Hz
	x-Axis;LIN;	Linear (LIN) or logarithmic (LOG) (future feature) scaling of the x-axis
	Sweep Count;1;	Selected number of sweeps
	Range 1:	Loop across all defined sweep ranges (1 to 20)
	Start; 9000.000000;Hz	Range start frequency in Hz
	Stop; 150000.000000;Hz	Range stop frequency in Hz
	Filter Type;NORMAL;	Range filter type: NORMAL, RRC or CFILTER
	RBW;10000.000000;Hz	Resolution bandwidth of the measurement filter
	VBW;30000.000000;Hz	Resolution bandwidth of the video filter
	Auto Sweep time;ON	
	Sweep time; 0.145000;s	Selected sweep time in the current range
	Detector;RMS;	Detector: MAX PEAK, MIN PEAK, RAVERAGE
	REF-Level; -10.000000;dBm	Setting of the reference level in the current range
	Auto RF-Attenuator; OFF;	Manual (OFF) or automatic (ON) setting of the RF attenuator
	RF Att;15.000000;dB	Range input attenuation
	Sweep Points;501;	Number of sweep points in the current range
Preamp; 0.000000;dB	Range preamplifier, on (20 dB) or off (0 dB)	
Stop after range;OFF;	Stop after range, switched on (ON) or off (OFF) for the current range	
Transducer;TRD1;	Transducer name (if activated) repeated for all sweep list ranges	

	File contents	Explanation
File data section	TRACE 1:	Selected trace
	x-Unit;Hz;	Unit of x values:
	y-Unit;dBm;	Unit of y values:
	Values;2500;	Number of measurement points
	9000.000000;-99.619965; 9225.961538;-105.416908; 9451.923077;-100.938057; 9677.884615;-99.483894; 9903.846154;-106.879539; 10129.807692;-108.772316;	Measurement values: <x value>; <y value>

6.15 OUTPut Subsystem

The OUTPut subsystem controls the output features of the instrument.

In conjunction with the tracking generator option, a distinction is made between OUTPut1 (screen A) and OUTPut2 (screen B).

OUTPut<1|2>[:STATe] ON | OFF

This command switches the tracking generator on or off.



- With the tracking generator switched on, the maximum stop frequency is limited to 3 GHz. This upper limit is automatically modified by the set frequency offset of the generator.
- If measurements in compliance with specs are to be performed with the tracking generator, the start frequency has to be $\geq 3 \times$ resolution bandwidth.
- The minimum sweep time for measurements in compliance with the data sheet is 100 ms in the frequency domain (span >0). If a shorter sweep time is selected, the sweep time indicator SWT on the screen is marked with a red asterisk and the message UNCAL is also displayed.

Example: "OUTP ON"
'Switches on the tracking generator in screen A.

Characteristics: *RST value: OFF
SCPI: conform

Mode: R, A

This command is only valid in conjunction with option tracking generator R&S FSP-B9.

OUTPut:UPORt[:VALue] #B00000000 to #B11111111

This command sets the control lines of the user ports. In manual operation, the control lines are represented by softkeys PORT 0 to 7.

The user port is written to with the given binary pattern. If the user port is programmed to INPut instead of OUTPut, the output value is temporarily stored.

Example: "OUTP:UPOR #B10100101"

Characteristics: *RST value: -
SCPI: device-specific

Mode: R, A

OUTPut:UPORt:STATe ON | OFF

This command switches the control line of the user ports between INPut and OUTPut.

The user port is switched to OUTPut with parameter ON, to INPut with OFF.

Example: "OUTP:UPOR:STAT ON"

Characteristics: *RST value: OFF
SCPI: device-specific

Mode: R, A

6.16 SENSe Subsystem

The SENSe subsystem is organized in several subsystems. The commands of these subsystems directly control device-specific settings, they do not refer to the signal characteristics of the measurement signal.

The SENSe subsystem controls the essential parameters of the R&S ESCI. In accordance with the SCPI standard, the key word "SENSe" is optional for this reason, which means that it is not necessary to include the SENSe node in command sequences.

The measurement windows are selected by SENSe1 and SENSe2:

SENSe1 = Modification of screen A settings

SENSe2 = Modification of screen B settings.

Screen A is automatically selected if 1 or 2 is missing.

In the receiver mode, the screen partitioning for the split-screen mode is fixed – bargraph at top and scan display below. Therefore, the numeric suffix is not required to select the measurement window.

6.16.1 SENSe:AVERage Subsystem

The SENSe:AVERage subsystem calculates the average of the acquired data. A new test result is obtained from several successive measurements.

There are two types of average calculation: logarithmic and linear. In case of logarithmic average calculation (denoted with VIDEo), the average value of the measured logarithmic power is calculated and in case of linear average calculation, the linear power is averaged before the logarithm is applied.

The measurement windows are selected by SENSe1 (screen A) and SENSe2 (screen B).

[SENSe<1|2>:]AVERage:COUNT 0 to 32767

In receiver mode, this command defines the number of scan started with single scan. In analyzer mode, it defines the number of measurements which contribute to the average value.

It should be noted that continuous averaging will be performed after the indicated number has been reached in continuous-sweep mode.

In single sweep or scan mode, the scan/sweep is stopped as soon as the indicated number of measurements (scans/sweeps) is reached. Synchronization to the end of the indicated number of measurements is only possible in single scan/sweep mode.

The command [SENSe<1|2>:]AVERage:COUNT is the same as command [SENSe<1|2>:]SWEep:COUNT. In both cases, the number of measurements is defined whether the average calculation is active or not.

The number of measurements is valid for all traces in the indicated measurement window.

Example:

```
"INIT:CONT OFF"
'Switching to single-sweep mode.

"AVER:COUN 16"
'Sets the number of measurements to 16.

"AVER:STAT ON"
'Switches on the calculation of average.

"INIT;*WAI"
'Starts the measurement and waits for the end of the 16 sweeps.
```

Characteristics: *RST value: 0
SCPI: conform

Mode: R, A

[SENSe<1|2>:]AVERage[:STATe<1...3>] ON | OFF

This command switches on or off the average calculation for the selected trace (STATe<1...3>) in the selected measurement window.

Example:

```
"AVER OFF"
'Switches off the average calculation for trace 1 in screen A.

"SENS2:AVER:STAT3 ON"
'Switches on the average calculation for trace 3 in screen B.
```

Characteristics: *RST value: OFF
SCPI: conform

Mode: R, A

[SENSe<1|2>:]AVERage:TYPE VIDEo | LINear

This command selects the type of average function. If VIDEo is selected, the logarithmic power is averaged and, if LINear is selected, the power values are averaged before they are converted to logarithmic values.

The type of average calculation is equally set for all traces in one measurement window.

Example: "AVER:TYPE LIN"
'Switches screen A to linear average calculation.

Characteristics: *RST value: VIDEo
SCPI: device-specific

Mode: A

6.16.2 SENSe:BANDwidth Subsystem

This subsystem controls the setting of the instrument's filter bandwidths. Both groups of commands (BANDwidth and BWIDth) perform the same functions.

The measurement windows are selected by SENSe1 (screen A) and SENSe2 (screen B).

[SENSe<1|2>:]BANDwidth|BWIDth:FFT WIDE | AUTO | NARROW

This command allows to specify between the following three options for FFT filters.

WIDE: The FFT filters with the greater partial span (this is the span which is covered with one FFT analysis) are used always.

AUTO: The firmware decides whether to use wide or narrow filters to achieve the best performance of the measurement.

NARROW: The FFT filters with the smaller partial span are used, this allows measurements near a carrier with reduced reference level, because of a more narrow analog prefilter.

Example: "BWID:FFT WIDE"

Characteristics: *RST value: AUTO
SCPI: device-specific

Mode: A

[SENSe<1|2>:]BANDwidth|BWIDth[:RESolution] 10 Hz to 3 MHz

This command defines the IF bandwidth or, in analyzer mode, the resolution bandwidth.

Analog resolution filters from 10 Hz to 3 MHz in 1, 3, 10 steps are available. These filters are implemented as 4-circuit LC filters in the range from 300 kHz to 3 MHz and as digital filters with analog characteristic in the range of 10 Hz to 100 kHz

In addition, the EMI bandwidths 200 Hz, 9 kHz, and 120 kHz are available (6 dB bandwidths each). The 1 MHz EMI bandwidth is the impulse bandwidth.

The EMI bandwidths are only available when parameter `PULSE` is selected by command `BAND:TYPE`. FFT filters from 1 Hz to 30 kHz (3 dB bandwidth each) are also available in the frequency domain (span > 0) for fast measurements on periodic signals. The instrument automatically switches to analog filters above 30 kHz.

The FFT bandwidths are not available if the preselector is switched on.

A number of especially steep-edged channel filters can be selected provided that parameters `CFILTER` or `RRC` are selected using the `BAND:TYPE` command. The possible combinations of filter type and filter bandwidth are listed in the table "List of available channel filters" of chapter "Instrument Functions", section "Setting the Bandwidths and Sweep Time – BW Key" on page 4.83.

If the resolution bandwidth is modified in analyzer mode, the coupling to the span is automatically switched off.

If the resolution bandwidth is modified in FM demodulator mode, the coupling to the demodulation bandwidth is automatically switched off.

Example: "BAND 120 kHz"
'Sets the IF bandwidth to 120 kHz

Characteristics: *RST value: - (AUTO is set to ON)
SCPI: conform

Mode: R, A

[SENSe<1|2>:]BANDwidth|BWIDth[:RESolution]:AUTO ON | OFF

In receiver mode with activated quasipeak detector, this command either automatically couples the IF bandwidth of the R&S ESCI to the frequency range or cancels the coupling.

In analyzer mode, this command either automatically couples the resolution bandwidth of the instrument to the span or cancels the coupling.

The automatic coupling adapts the resolution bandwidth to the currently set frequency span according to the relationship between frequency span and resolution bandwidth.

The 6 dB bandwidths 200 Hz, 9 kHz and 120 kHz and the channel filters are not set by the automatic coupling.

The ratio resolution bandwidth/span can be modified with the command [SENSe<1|2>:]BANDwidth[:RESolution]:RATio.

Example: "BAND:AUTO OFF"
 'Switches off the coupling of the IF bandwidth to the frequency range (receiver mode).
 'Switches off the coupling of the resolution bandwidth to the span (analyzer mode).

Characteristics: *RST value: ON
 SCPI: conform

Mode: R, A-F

[SENSe<1|2>:]BANDwidth|BWIDth[:RESolution]:RATio 0.0001 to 1

This command defines the ratio resolution bandwidth (Hz) / span (Hz). The ratio to be entered is reciprocal to the ratio span/RBW used in manual operation.

Example: "BAND:RAT 0.1"

Characteristics: *RST value: 0.02 with BAND:TYPE NORMAl or RBW > 30 kHz
 0.01 with BAND:TYPE FFT for RBW ≤ 30 kHz
 SCPI: conform

Mode: A

[SENSe<1|2>:]BANDwidth|BWIDth[:RESolution]:TYPE NORMAl | CFILter | RRC | FFT | NOISe | PULSe

This command switches the filter type for the resolution bandwidth between "normal" analog or FIR filters in 1, 3, 10 steps and the FFT filtering for bandwidths <100 kHz.

The advantage of FFT filtering is the higher measurement speed compared to digital filters with analog filter characteristic. However, FFT filters are only suitable for periodic signals, and they are only available for span > 0 Hz.

Steep-edged channel filters and filters with RRC (Root Raised Cosine) characteristic are available. The possible combinations of filter type and filter bandwidth are listed in in chapter "[Instrument Functions](#)", section "[Filter Types](#)" on page 4.88.

The filter type NOISe selects the 3 dB bandwidths for analyzer, filter type PULSe selects the 6 dB bandwidths for EMI measurements.



When changing the filter type, the next larger filter bandwidth is selected if the same filter bandwidth is not available for the new filter type.

Example: "BAND:TYPE NORM"

Characteristics: *RST value: NORMAL
SCPI: device-specific

Mode: R, A

[SENSe<1|2>:]BANDwidth|BWIDth:VIDeo 1Hz to 10MHz

This command defines the instrument's video bandwidth. Bandwidths from 10 Hz to 10 MHz in 1, 3, 10 steps are available. The command is not available if FFT filtering is switched on and the set bandwidth is ≤ 30 kHz or if the quasipeak detector is switched on.



In receiver mode, the video bandwidth is set to ten times the resolution bandwidth.

Example: "BAND:VID 10kHz"

Characteristics: *RST value: - (AUTO is set to ON)
SCPI: conform

Mode: A

[SENSe<1|2>:]BANDwidth|BWIDth:VIDeo:AUTO ON | OFF

This command either automatically couples the instrument's video bandwidth to the resolution bandwidth or cancels the coupling.

The ratio video bandwidth/resolution bandwidth can be modified with the command [SENSe<1|2>:]BANDwidth:VIDeo:RATio.



In receiver mode, the video bandwidth is set to ten times the resolution bandwidth.

Example: "BAND:VID:AUTO OFF"

Characteristics: *RST value: ON
SCPI: conform

Mode: A

[SENSe<1|2>:]BANDwidth|BWIDth:VIDeo:RATio 0.01 to 1000

This command defines the ratio video bandwidth (Hz) / resolution bandwidth (Hz). The ratio to be entered is reciprocal to the ratio RBW/VBW used in manual operation.



In receiver mode, the video bandwidth is set to ten times the resolution bandwidth.

Example: "BAND:VID:RAT 3"
'Sets the coupling of video bandwidth to video bandwidth = 3*resolution bandwidth

Characteristics: *RST value: 3
SCPI: conform

Mode: A

[SENSe<1|2>:]BANDwidth|BWIDTH:VIDeo:TYPE LINear | LOGarithmic

This command selects the position of the video filter in the signal path, provided that the resolution bandwidth is ≤ 100 kHz:

- If LINear is selected, the video filter is connected ahead of the logarithmic amplifier (default)
- If LOGarithmic is selected, the video filter follows the logarithmic amplifier

The essential difference between the two modes is the transient response at falling signal edges:

If LINear is selected, the measurement with logarithmic level scaling yields a much "flatter" falling edge than LOGarithmic. This behavior is due to the conversion of linear power into logarithmic level. If the linear power is halved, the level decreases by only 3 dB.

Example: "BAND:VID:TYPE LIN"
'Video filter ahead of the logarithmic amplifier

Characteristics: *RST value: LIN
SCPI: device-specific

Mode: A

6.16.3 SENSe:CORRection Subsystem

The SENSe:CORRection subsystem controls the correction of measured results by means of frequency-dependent correction factors (e.g. for antenna or cable attenuation).

This subsystem also controls calibration and normalization during operation with the tracking generator options (B9/B10). The measurement windows are selected by SENSe1 (screen A) and SENSe2 (screen B).

[SENSe<1|2>:]CORRection[:STATe] ON | OFF

This command activates/deactivates the normalization of the measurement results in the selected window provided that the tracking generator is active. The command is available only after acquisition of a reference trace for the selected type of measurement (transmission/reflection, see command [SENSe<1|2>:]CORRection:COLLect[:ACQire]).

Example: "CORR ON "
'Activates normalization in screen A.

Characteristics: *RST value: OFF
SCPI: conform

Mode: A

This command is only valid in conjunction with the tracking generator / ext. generator control option (B9/B10).

[SENSe<1|2>:]CORRection:METHod TRANsmission | REFLection

This command selects the type of measurement with active tracking generator (transmission/reflection).

Example: "CORR:METH TRAN "
'Sets the type of measurement in screen A to "transmission".

Characteristics: *RST value: TRANsmission
SCPI: device-specific

Mode: A

This command is only valid in conjunction with the tracking generator / ext. generator control option (B9/B10).

[SENSe<1|2>:]CORRection:COLLect[:ACQire] THRough | OPEN

When the tracking generator is active, this command determines the type of result acquisition for the normalization reference measurement and starts the measurement selected:

Parameter: THRough:
TRANsmission mode: calibration with direct connection between tracking generator and device input.
REFLection mode: calibration with short circuit at the input
OPEN: only valid in REFLection mode: calibration with open input

To obtain a valid reference measurement, a complete sweep with synchronization to the end of the sweep must have been carried out. This is only possible in the single-sweep mode.

Example: "INIT:CONT OFF"
'Selects single sweep operation

"CORR:COLL THR;*WAI"
'Starts the measurement of reference data using direct connection between generator and device input and waits for the sweep end.

Characteristics: *RST value: --
SCPI: conform

Mode: A

This command is an "event" and therefore has no *RST value and no query.

This command is only valid in conjunction with the tracking generator / ext. generator control option (B9/B10).

[SENSe<1|2>:]CORRection:RECall

This command restores the instrument setting that was valid for the measurement of the reference data, provided that the tracking generator is active.

Example: "CORR:REC"

Characteristics: *RST value: -
SCPI: conform

Mode: A

This command is an event and therefore has no *RST value and no query.

This command is only valid in conjunction with the tracking generator / ext. generator control option (B9/B10).

[SENSe<1|2>:]CORRection:TRANsducer:ACTive?

This command queries the active transducer factor. If no transducer factor is active, an empty string is returned.

Example: "CORR:TRAN:ACT?"

Characteristics: *RST value: -
SCPI: device-specific

Mode: R, A

This command is a query and therefore has no *RST value.

[SENSe<1|2>:]CORRection:TRANsducer:CATalog?

This command queries all the names of the transducer files saved on the hard disc.

The syntax of the output is:

<sum of file length of all following files>,<free spaces on hard disc>,<1st file name>,<1st file length>,<2nd file name>,<2nd file length>,...,<nth file name>,<nth file length>

Example: "CORR:TRAN:CAT?"

Characteristics: *RST value: -
SCPI: device-specific

Mode: R, A

[SENSe<1|2>:]CORRection:TRANsducer:GENerate <name>

This command generates a transducer factor <name> using normalized trace data. The function is only available when normalization is switched on.

Parameter: <name>::= Name of the transducer factors as string data with up to 8 characters.

Example: "CORR:TRAN:GEN 'FACTOR1'"

Characteristics: *RST value: -
SCPI: device-specific

Mode: A

[SENSe<1|2>:]CORRection:TRANsducer:SELection <name>

This command selects the transducer factor designated by <name>. If <name> does not exist yet, a new transducer factor is created.



This command must be sent prior to the subsequent commands for modifying/activating transducer factors.

Parameter: <name>::= Name of the transducer factor in string data form with a maximum of 8 characters.

Example: "CORR:TRAN:SEL 'FACTOR1'"

Characteristics: *RST value: -
SCPI: device-specific

Mode: R, A

[SENSe<1|2>:]CORRection:TRANsducer:UNIT <string>

This command specifies the unit for the selected transducer factor. Prior to this command, the command `SENS:CORR:TRAN:SEL` must be sent.

Parameter: <string>::= 'DB' | 'DBM' | 'DBMV' | 'DBUV' | 'DBUV/M' | 'DBUA' | 'DBUA/M' | 'DBPW' | 'DBPT'

Example: "CORR:TRAN:SEL 'FACTOR1'"
"CORR:TRAN:UNIT 'DBUV'"

Characteristics: *RST value: 'DB'
SCPI: device-specific

Mode: R, A

[SENSe<1|2>:]CORRection:TRANsducer:SCALing LINear | LOGarithmic

This command defines whether the frequency scaling of the transducer factor is linear or logarithmic. Prior to this command, the command `SENS:CORR:TRAN:SEL` must be sent.

Example: `"CORR:TRAN:SEL 'FACTOR1'"`
`"CORR:TRAN:SCAL LOG"`

Characteristics: *RST value: LINear
 SCPI: device-specific

Mode: R, A

[SENSe<1|2>:]CORRection:TRANsducer:COMMeNT <string>

This command defines the comment for the selected transducer factor. Prior to this command, the command `SENS:CORR:TRAN:SEL` must be sent.

Example: `"CORR:TRAN:SEL 'FACTOR1'"`
`"CORR:TRAN:COMM 'FACTOR FOR ANTENNA'"`

Characteristics: *RST value: " (empty comment)
 SCPI: device-specific

Mode: R, A

[SENSe<1|2>:]CORRection:TRANsducer:DATA <freq>,<level>..

This command defines the reference values of the transducer factor selected. These values are entered as a sequence of frequency/level pairs. The frequencies must be sent in ascending order. Prior to this command, the command `SENS:CORR:TRAN:SEL` must be sent. The level values are sent as dimensionless numbers; the unit is specified by means of the command `SENS:CORR:TRAN:UNIT`.

Example: `"CORR:TRAN:SEL 'FACTOR1'"`
`"CORR:TRAN:TRANsducer:DATA 1MHZ,-30,2MHZ,-40"`

Characteristics: *RST value: -
 SCPI: device-specific

Mode: R, A

[SENSe<1|2>:]CORRection:TRANsducer[:STATe] ON | OFF

This command switches the selected transducer factor on or off. Prior to this command, the command `SENS:CORR:TRAN:SEL` must be sent.

Example: `"CORR:TRAN:SEL 'FACTOR1'"`
`"CORR:TRAN ON"`

Characteristics: *RST value: OFF
 SCPI: device-specific

Mode: R, A

[SENSe<1|2>:]CORRection:TRANsducer:DELeTe

This command deletes the selected transducer factor. Prior to this command, the command `SENS:CORR:TRAN:SEL` must be sent.

Example: `"CORR:TRAN:SEL 'FACTOR1'"`
 `"CORR:TRAN:DEL"`

Characteristics: *RST value: -
 SCPI: device-specific

Mode: R, A

This command is an event and therefore has no *RST value.

[SENSe<1|2>:]CORRection:TRANsducer:VIEW ON | OFF

This command switches on the display of the active transducer factor or set. Prior to this command, the command `SENS:CORR:TRAN:SEL` must be sent.

This command is available from firmware version 1.40 or higher.

Example: `"CORR:TRAN:SEL 'FACTOR1'"`
 `"CORR:TRAN:VIEW ON"`

Characteristics: *RST value: OFF
 SCPI: device-specific

Mode: R, A

[SENSe<1|2>:]CORRection:TRANsducer:ADJust:RLEVe[[:STATe]] ON | OFF

This command switches the automatic adjustment of the reference level to the selected transducer factor on or off. Prior to this command, the command `SENS:CORR:TRAN:SEL` must be sent.

Example: `"CORR:TRAN:SEL 'FACTOR1'"`
 `"CORR:CORR:TRAN:ADJ:RLEV ON"`

Characteristics: *RST value: OFF
 SCPI: device-specific

Mode: R, A

[SENSe<1|2>:]CORRection:TSET:SELeCt <name>

This command selects the transducer set designated by <name>. If <name> does not exist yet, a new set is created.



This command must be sent prior to the subsequent commands for modifying/activating transducersets.

Parameter: <name> ::= name of the transducer set in string data form with a maximum of 8 characters.

Example: `"CORR:TSET:SEL 'SET1'"`

Characteristics: *RST value: -
 SCPI: device-specific

Mode: R, A

[SENSe<1|2>:]CORRection:TSET:UNIT <string>

This command defines the unit of the selected transducer sets. When assigning transducer factors to the set, only factors which are compatible to the selected unit, i.e. factors with the same unit or the unit dB, are allowed. Prior to this command, the command `SENS:CORR:TSET:SEL` must be sent.

Parameter: <string>::= 'DB' | 'DBM' | 'DBUV' | 'DBUV/M' | 'DBUA' | 'DBUA/M' | 'DBPW' | 'DBPT'

Example:
`"CORR:TSET:SEL 'SET1'"`
`"CORR:TSET:UNIT 'DBUV'"`

Characteristics: *RST value: 'DB'
 SCPI: device-specific

Mode: R, A

[SENSe<1|2>:]CORRection:TSET:BR EAk ON | OFF

This command defines if the sweep is to be stopped on changeover from range to another. Prior to this command, the command `SENS:CORR:TSET:SEL` must be sent.

Example:
`"CORR:TSET:SEL 'SET1'"`
`"CORR:TSET:BR EAk ON"`

Characteristics: *RST value: OFF
 SCPI: device-specific

Mode: R, A

[SENSe<1|2>:]CORRection:TSET:CATalog?

This command reads out the names of all transducer sets stored on the internal drive.

Syntax of output format:

<Sum of file lengths of all subsequent files>,<free memory on hard disk>, <1st file name>,<1st file length>,<2nd file name>,<2nd file length>,...,<nth file name>,<nth file length>

Example:
`"CORR:TSET:SEL 'SET1'"`
`"CORR:TSET:CAT?"`

Characteristics: *RST value: --
 SCPI: device-specific

Mode: R, A

[SENSe<1|2>:]CORRection:TSET:COMMeNT <string>

This command defines the comment for the selected transducer set. Prior to this command, the command `SENS:CORR:TSET:SEL` must be sent.

Example:
`"CORR:TSET:SEL 'SET1'"`
`"CORR:TSET:COMM 'SET FOR ANTENNA'"`

Characteristics: *RST value: " (empty comment)
 SCPI: device-specific

Mode: R,A

[SENSe<1|2>:]CORRection:TSET:RANGe<1 to 10> <freq>,<freq>,<name>..

This command defines a partial range of the selected transducer set. The partial range is determined by its start and stop frequencies plus a list of names of the assigned transducer factors. The ranges 1 to 10 must be sent in ascending order. Prior to this command, the command `SENS:CORR:TSET:SEL` must be sent.

Parameter: <freq>,<freq>:= start frequency, stop frequency of the range
<name>...:= list of names for the assigned transducer factors.
The individual names must be characterized by single quotation marks (') and separated by commas.

Example: `"CORR:TSET:SEL 'SET1'"`
`"CORR:TRAN:TSET:RANG 1MHZ,2MHZ, 'FACTOR1, 'FACTOR2'"`

Characteristics: *RST value: -
SCPI: device-specific

Mode: R, A

[SENSe<1|2>:]CORRection:TSET[:STATe] ON | OFF

This command switches the selected transducer set on or off.

Example: `"CORR:TSET:SEL 'SET1'"`
`"CORR:TSET ON"`

Characteristics: *RST value: OFF
SCPI: device-specific

Mode: R, A

[SENSe<1|2>:]CORRection:TSET:DELeTe

This command deletes the selected transducer set.

Example: `"CORR:TSET:SEL 'SET1'"`
`"CORR:TSET:DEL"`

Characteristics: *RST value: -
SCPI: device-specific

Mode: R, A

This command is an event and therefore has no *RST value.

6.16.4 SENSe:DEMod Subsystem

The SENSe:DEMod subsystem controls the analog demodulation of the video signal. The measurement window is selected by SENSE1 (screen A) and SENSE2 (screen B).

[SENSe<1|2>:]DEMod OFF | AM | FM

This command selects the type of analog demodulation.

Example: "DEM FM"

Characteristics: *RST value: OFF
SCPI: device-specific

Mode: R

[SENSe<1|2>:]DEMod:SQUelch:LEVel <numeric_value> | MIN | MAX | DEF

This command enables the input of a level threshold below which the audible AF is cut off.

Example: "SENSe:DEM:SQU:LEV 80"
'Sets the squelch level to 80.'

Characteristics: *RST value: 60
SCPI: device-specific

Mode: R

6.16.5 SENSe:DETECTOR Subsystem

The SENSe:DETECTOR subsystem controls the acquisition of measurement data via the selection of the detector for the corresponding trace. The measurement windows are selected by SENSe1 (screen A) and SENSe2 (screen B).

[SENSe<1|2>:]DETECTOR<1..3>[:FUNCTION] APEak | NEGative | POSitive | SAMPlE | RMS | AVERAge
| QPEak | CAVERage | CRMS

This command sets the detector for recording measured values for the selected trace in the specified measurement window.

- The APEak detector (AutoPeak) displays the positive and also the negative peak value of the noise floor. If a signal is detected, only the positive peak value is displayed.
- The POSitive or NEGative detector only displays the positive or the negative peak value.
- With the Sample detector the value measured at the sampling time is displayed, whereas the RMS value of the power measured at each measurement point is displayed with the RMS detector.
- The AVERAge detector displays the power average value at each measurement point.
- The detectors QPEak for quasipeak, CAVERage for CISPR average and CRMS for CISPR-RMS perform standard-compliant signal evaluations for the EMC test equipment.

If QPEak is selected, the video filter is automatically switched off. In addition, the couplings between the span and RBW as well as between RBW and the sweep time are switched off. They are not restored until another detector is selected. Accordingly, the sweep time should be set to a value that is large enough so that the quasipeak detector can settle in completely at each measurement point.

The trace is indicated as a numerical suffix for DETECTOR.

Example: "DET POS"
'Sets the detector in screen A to "positive peak".

Characteristics: *RST value: APEak
SCPI: conform

Mode: A

[SENSe<1|2>:]DETECTOR<1..3>[:FUNCTION]:AUTO ON | OFF

This command either couples the detector in the selected measurement window to the current trace setting or turns coupling off. The trace is selected by the numeric suffix at DETECTOR.

Example: "DET:AUTO OFF"

Characteristics: *RST value: ON
SCPI: conform

Mode: A

[SENSe<1|2>:]DETEctor<1..3>:RECEiver[:FUNction] POSitive | NEGative | RMS | AVERage | QPEak | CAVERage | CRMS

In receiver mode, this command switches on the detectors for an individual measurement to record measured values.

The trace cannot be selected; three detectors can be switched on simultaneously.

Example: "DET:REC POS,AVER,QPE"
'Switches on the peak, average and quasipeak detectors.

Characteristics: *RST value: AVER
SCPI: device-specific

Mode: R

[SENSe<1|2>:]DETEctor<1..3>:FMEasurement NEGative | POSitive | RMS | AVERage | QPEak | CAVERage | CRMS

This command selects the detector for the final measurement which is performed subsequent to the overview measurement.

Example: "DET:FME POS"

Characteristics: *RST value: Trace 1 QPEak
Trace 2 AVERage
Trace 3 RMS
SCPI: device-specific

Mode: R

6.16.6 SENSe:ESpectrum Subsystem

This chapter describes all remote control commands available to configure Spectrum Emission Mask measurements.

[SENSe<1|2>:]ESpectrum:BWIDth numeric_value

This command defines the bandwidth used for measuring the channel power in the Spectrum Emission Mask measurement. Allowed range: 20 Hz ...span of reference range.

The numeric suffix at SENSe<1|2> is irrelevant.

Example: "ESP:BWIDT 3.84MHz"
'sets the channel bandwidth to 3.84MHz

Characteristics: *RST value: 3.84 MHz
SCPI: device-specific

Mode: A

[SENSe<1|2>:]ESpectrum:FILTer:RRC[:STATe] ON | OFF

This command activates or deactivates the use of a RRC filter for measuring the channel power in the Spectrum Emission Mask measurement.

The numeric suffix at SENSe<1|2> is irrelevant.

Example: "ESP:FILT ON"
'RRC filter switched on

Characteristics: *RST value: ON
SCPI: device-specific

Mode: A

[SENSe<1|2>:]ESpectrum:FILTER:RRC:ALPHA 0...1

This command sets the alpha value of the RRC filter for measuring the channel power in the Spectrum Emission Mask measurement if the RRC filter is switched on.

The numeric suffix at SENSe<1|2> is irrelevant.

Example: "ESP:FILT ON"
'RRC filter switched on

Characteristics: *RST value: 0.22
SCPI: device-specific

Mode: A

[SENSe<1|2>:]ESpectrum:PRESet[:STANDARD] 'xml_file'

This command selects the specified XML file under *D:\r_s\instr\sem_std*. If the file is stored in a subdirectory, include the relative path.

The query returns information about the selected standard, the power class and the link direction. If no standard has been selected, the query returns "".

This command is an event and therefore has no *RST value and no query.

The numeric suffix at SENSe<1|2> is irrelevant.

Example: "ESP:PRES 'WCDMA\3GPP\DL\PowerClass_31_39.xml"
'Selects the PowerClass_31_39.xml XML file in the folder
'D:\R_S\instr\sem_std\WCDMA\3GPP\DL.
"ESP:PRES?"
'Returns 'W-CDMA 3GPP (31,39)dBm DL

Characteristics: *RST value:
SCPI: device-specific

Mode: A

[SENSe<1|2>:]ESpectrum:PRESet:RESTore

This command copies the XML files from the *D:\R_S.FW\instr\sem_backup* folder to the *D:\R_S\instr\sem_std* folder. Files of the same name are overwritten.

This command is an event and therefore has no *RST value and no query.

The numeric suffix at SENSe<1|2> is irrelevant.

Example: "ESP:PRES:REST"
'Restores the originally provided XML files.

Characteristics: *RST value:-
SCPI: device-specific

Mode: A

[SENSe<1|2>:]ESpectrum:RANGe<1...20>:BANDwidth[:RESolution] <numeric_value>

This command selects the resolution bandwidth (RBW) of a range in the Spectrum Emission Mask measurement.

The numeric suffix at SENSe<1|2> is irrelevant.

Example: "ESP:RANG2:BAND 10E3"
'sets the RBW to 10 KHz

Characteristics: *RST value: 10 kHz
SCPI: device-specific

Mode: A

[SENSe<1|2>:]ESpectrum:RANGe<1...20>:BANDwidth:VIDeo <numeric_value>

This command selects the video bandwidth (VBW) of a range in the Spectrum Emission Mask measurement.

The numeric suffix at SENSe<1|2> is irrelevant.

Example: "ESP:RANG2:BAND:VIDeo 100E3"
'sets the VBW to 100 KHz

Characteristics: *RST value: 30 kHz
SCPI: device-specific

Mode: A

[SENSe<1|2>:]ESpectrum:RANGe<1...20>:COUNT?

This command indicates the number of defined ranges of the Spectrum Emission Mask measurement.

The numeric suffixes <1|2> at SENSe and <1 to 20> at RANGe are irrelevant for this command.

Example: "ESP:RANG:COUN?"
'indicates the number of ranges

Characteristics: *RST value: OFF
SCPI: device-specific

Mode: A

[SENSe<1|2>:]ESpectrum:RANGe<1...20>:DELeTe

This command deletes a range of the Spectrum Emission Mask measurement configuration.

The numeric suffix at SENSe<1|2> is irrelevant.

Example: "ESP:RANG2:DEL"
'deletes range 2

Characteristics: *RST value:-
SCPI: device-specific

Mode: A

[SENSe<1|2>:]ESpectrum:RANGe<1...20>:FILTer:TYPE NORMal | CFILter | RRC | PULSe

This command sets the filter in the Spectrum Emission Mask measurement.

The numeric suffix at SENSe<1|2> is irrelevant.

Example: "ESP:RANG2:FILT:TYPE RRC"
'RRC filter

Characteristics: *RST value: NORMal
SCPI: device-specific

Mode: A

[SENSe<1|2>:]ESpectrum:RANGe<1...20>[:FREQUENCY]:START <numeric_value>

This command sets the relative start frequency of a range in the Spectrum Emission Mask measurement.

The numeric suffix at SENSe<1|2> is irrelevant.

Example: "ESP:RANG2:STAR -2.52MHz"
'start frequency of range 2 to -2.52 MHz

Characteristics: *RST value:-
SCPI: device-specific

Mode: A

[SENSe<1|2>:]ESpectrum:RANGe<1...20>[:FREQUENCY]:STOP <numeric_value>

This command sets the relative stop frequency of a range in the Spectrum Emission Mask measurement.

The numeric suffix at SENSe<1|2> is irrelevant.

Example: "ESP:RANG2:STOP 2.52MHZ"
'stop frequency of range 2 to +2.52MHz

Characteristics: *RST value:-
SCPI: device-specific

Mode: A

[SENSe<1|2>:]ESpectrum:RANGe<1...20>:INPut:ATTenuation <numeric_value>

This command defines the RF attenuation of a range in the Spectrum Emission Mask measurement.

The numeric suffix at SENSe<1|2> is irrelevant.

Example: "ESP:RANG2:INP:ATT 30db"
'RF attenuation of range 2 to 30 dB

Characteristics: *RST value:-
SCPI: device-specific

Mode: A

[SENSe<1|2>:]ESpectrum:RANGe<1...20>:INPut:ATTenuation:AUTO ON | OFF

This command switches the attenuation mode of a range in the Spectrum Emission Mask measurement to AUTO (ON) or MANUAL (OFF).

The numeric suffix at SENSe<1|2> is irrelevant.

Example: "ESP:RANG2:INP:ATT:AUTO ON"
'attenuation mode is AUTO for range 2

Characteristics: *RST value: ON
SCPI: device-specific

Mode: A

[SENSe<1|2>:]ESpectrum:RANGe<1...20>:INPut:GAIN:STATe ON | OFF

This command switches the preamplifier of a range in the Spectrum Emission Mask measurement on or off.

The numeric suffix at SENSe<1|2> is irrelevant.

Example: "ESP:RANG2:INP:GAIN:STAT ON"
'activates the preamplifier for range 2

Characteristics: *RST value: OFF
SCPI: device-specific

Mode: A

[SENSe<1|2>:]ESpectrum:RANGe<1..20>:LIMit:ABSolute:START <numeric_value>

This command defines the absolute limit at the start frequency of the range for the Spectrum Emission Mask measurement.

The numeric suffix at SENSe<1|2> is irrelevant.

Example: "ESP:RANG5:LIM:ABS:START -40"
'Abs limit at Startfreq. in Range 5 is -40dBm

Characteristics: *RST value: -13dBm
SCPI: device-specific

Mode: A

[SENSe<1|2>:]ESpectrum:RANGe<1..20>:LIMit:ABSolute:STOP <numeric_value>

This command defines the absolute limit at the stop frequency of the range for the Spectrum Emission Mask measurement.

The numeric suffix at SENSe<1|2> is irrelevant.

Example: "ESP:RANG5:LIM:ABS:STOP -40"
'Abs Limit at Stop Freq. in Range 5 is -40dBm

Characteristics: *RST value: -13dBm
SCPI: device-specific

Mode: A

[SENSe<1|2>:]ESpectrum:RANGe<1..20>:INSert AFTer | BEFore

This command inserts a new range before or after the specified range. The range numbers are updated accordingly. The numeric suffix at RANGe<1...20> specify the range.

The numeric suffix at SENSe<1|2> is irrelevant.

Example: "ESP:RANG3:INS BEF"
 'Inserts a new range before Range 3
 "ESP:RANG1:INS AFT"
 'Inserts a new range after Range 1

Characteristics: *RST value:-
 SCPI: device-specific

[SENSe<1|2>:]ESpectrum:RANGe<1..20>:LIMit:RELative:START <numeric_value>

This command defines the absolute limit at the start frequency of the range for the Spectrum Emission Mask measurement.

The numeric suffix at SENSe<1|2> is irrelevant.

Example: "ESP:RANG5:LIM:ABS:START -40"
 'Abs limit at Startfreq. in Range 5 is -40dBm

Characteristics: *RST value: -13dBm
 SCPI: device-specific

Mode: A

[SENSe<1|2>:]ESpectrum:RANGe<1..20>:LIMit:RELative:STOP <numeric_value>

This command defines the absolute limit at the stop frequency of the range for the Spectrum Emission Mask measurement.

The numeric suffix at SENSe<1|2> is irrelevant.

Example: "ESP:RANG5:LIM:ABS:STOP -40"
 'Abs Limit at Stop Freq. in Range 5 is -40dBm

Characteristics: *RST value: -13dBm
 SCPI: device-specific

Mode: A

[SENSe<1|2>:]ESpectrum:RANGe<1..20>:LIMit:STATe ABSolute | RELative | AND | OR

This command sets the type of limit check for all ranges of Spectrum Emission Mask measurement.

- ABSolute
 Checks only the absolute limits defined
- RELative:
 Checks only the relative limits. Relative limits are defined as relative to the measured power in the reference range.
- AND
 Combines the absolute and relative limit. The limit check fails when both limits are violated.
- OR
 Combines the absolute and relative limit. The limit check fails when one of the limits is violated.

The numeric suffixes at SENSe<1|2> and the numeric suffix at RANGe<1..20> are irrelevant.

Example: "ESP:RANG5:LIM -40"
 'limit in range 5 is -40dBm
 "ESP:RANG7:LIM -20"
 'limit in range 7 is -20dBm
 "ESP:RANG:LIM:STAT ON"
 'activates limit checking

Characteristics: *RST value: OFF
 SCPI: device-specific

Mode: A

[SENSe<1|2>:]ESpectrum:RANGe<1...20>:RLEVel <numeric_value>

This command defines the reference level of a range in the Spectrum Emission Mask measurement.
 The numeric suffix at SENSe<1|2> is irrelevant.

Example: "ESP:RANG2:RLEV -30"
 'sets the reference level in range 2 to -30 dBm

Characteristics: *RST value:-
 SCPI: device-specific

Mode: A

[SENSe<1|2>:]ESpectrum:RANGe<1...20>:SWEep:TIME <numeric_value>

This command defines the sweep duration of a range in the Spectrum Emission Mask measurement.

Example: "ESP:RANG2:SWE:TIME 1MS"
 'sets the sweep time in range 2 to 1 ms

Characteristics: *RST value:-
 SCPI: device-specific

Mode: A

[SENSe<1|2>:]ESpectrum:RANGe<1...20>:SWEep:TIME:AUTO ON | OFF

This command controls the automatic coupling of the sweep duration on the frequency span and the bandwidth settings in a Spectrum Emission Mask measurement range.

The numeric suffix at SENSe<1|2> is irrelevant.

Example: "ESP:RANG2:SWE:TIME:AUTO ON"
 'activates the coupling of frequency range and bandwidths in range 2

Characteristics: *RST value: ON
 SCPI: device-specific

Mode: A

[SENSe<1|2>:]ESpectrum:RANGe<1...20>:TRANsducer <string>

This command sets the transducer factor for a range in the Spectrum Emission Mask measurement.
 The numeric suffix at SENSe<1|2> is irrelevant.

Example: "ESP:RANG2:TRAN ON 'fac_1'"
 'sets the transducer factor fac_1 in range 2

Characteristics: *RST value:-
SCPI: device-specific

Mode: A

[SENSe<1|2>:]ESpectrum:RRANge?

This command returns the number of the reference range of the Spectrum Emission Mask measurement.

The numeric suffix at SENSe<1|2> is irrelevant.

Example: "ESP:RRAN?"

Characteristics: *RST value:-
SCPI: device-specific

Mode: A

[SENSe<1|2>:]ESpectrum:RTYPE PEAK | CPOWer

This command sets selects the type of power measurement in the reference range:

- PEAK:
Measures the highest peak within the reference range.
- CHAN:
Measures the channel power within the reference range (integral bandwidth method).

The numeric suffix at SENSe<1|2> is irrelevant.

Example: "ESP:RTYP PEAK"
'selects highest peak

Characteristics: *RST value: CPOW
SCPI: device-specific

Mode: A

6.16.7 SENSe:FMEasurement Subsystem

This subsystem controls the parameters of final measurement.

[SENSe<1|2>:]FMEasurement:THReshold[:STATe] ON | OFF

This command switches the threshold scan function (direct final measurement during the scan) on and off.

Example: "FME:THR ON "

Characteristics: *RST value: OFF
SCPI: device-specific

Mode: R

[SENSe<1|2>:]FMEasurement:NBBB[:STATe] ON | OFF <numeric_value>:

This command switches on automatic detection of narrowband and broadband interference signals. The detector for the final measurement is also automatically selected.

Example: "FME:NBBB ON"

Characteristics: *RST value: OFF
SCPI: device-specific

Mode: R

[SENSe<1|2>:]FMEasurement:NBBB:LEVel <numeric_value>:

This command enters the decision threshold to discriminate between broadband and narrowband interference.

Example: "FME:NBBB:LEV 6 DB "

Characteristics: *RST value: 6 dB
SCPI: device-specific

Mode: R

[SENSe<1|2>:]FMEasurement:AUTO ON | OFF

This command switches between automatic and interactive final measurement.

Example: "FME:AUTO ON"

Characteristics: *RST value: ON
SCPI: device-specific

Mode: R

[SENSe<1|2>:]FMEasurement:LISN[:TYPE] TWOPhase | FOURphase | ESH3Z5 | ESH2Z5 | ENV4200 | ENV216 | OFF

This command selects whether a V-network is driven automatically via the user port in the final measurement and, if yes, which one:

TWOPhase and ESH3Z5	R&S ESH3-Z5 (two phases and protective earth are controllable)
FOURphase and ESH2Z5	R&S ESH2-Z5 (four phases and protective earth are controllable)
ENV4200	R&S ENV 4200 (four phases are controllable)
ENV216	R&S ENV 216 (two phases and highpass are controllable)
OFF	Remote control deactivated

Example: ":FME:LISN:TWOP"

Characteristics: *RST value: OFF
SCPI: device-specific

Mode: R

[SENSe<1|2>:]FMEasurement:LISN:PHASe L1 | L2 | L3 | N[[,L1 | L2 | L3 | N],...]

This command selects the phases of the V-network on which level measurements are consecutively performed in the final measurement. L2 and L3 are only available with four-line V-networks (FMEasurement:LISN FOURphase | ENV4200).

Example: ":FME:LISN:PHAS L1,N"

Characteristics: *RST value: L1
SCPI: device-specific

Mode: R

[SENSe<1|2>:]FMEasurement:LISN:PEARth GROunded | FLOating[,GROunded | FLOating]

This command selects the ground settings on the V-network on which level measurements are consecutively performed in the final measurement. This command is available only for certain V-networks (FMEasurement:LISN FOURphase | TWOPhase | ESH3Z5 | ESH2Z5).

Example: ":FME:LISN:PEAR GRO,FLO"

Characteristics: *RST value: GRO
SCPI: device-specific

Mode: R

[SENSe<1|2>:]FMEasurement:LISN:FILTer:HPAS[:STATe] ON | OFF

This command selects the setting for the high pass on the V-network with which the level measurement is performed in the final measurement. This command is available only for the R&S ENV 216 V-network (FMEasurement:LISN ENV216).

Example: ":FME:LISN:FILT:HPAS ON"

Characteristics: *RST value: ON
SCPI: device-specific

Mode: R

[SENSe<1|2>:]FMEasurement:TIME <numeric_value>

This command defines the measurement time in which the values indicated in the peak list (final measurement values) are re-checked.

Example: ":FME:TIME 0.01"

Characteristics: *RST value: 1 s
SCPI: device-specific

Mode: R

6.16.8 SENSe:FREQuency Subsystem

The SENSe:FREQuency subsystem defines the frequency axis of the active display. The frequency axis can either be defined via the start/stop frequency or via the center frequency and span.

The measurement windows are selected by SENSe1 (screen A) and SENSe2 (screen B).

[SENSe<1|2>:]FREQuency:CENTer 0 to f_{\max}

This command defines the receiver frequency or the center frequency in analyzer mode.

Example: "FREQ:CENT 100MHz"

Characteristics: *RST value: $f_{\max} / 2$ with f_{\max} = maximum frequency
SCPI: conform

Mode: R, A

[SENSe<1|2>:]FREQuency:CENTer:STEP 0 to f_{\max}

This command defines the step width of the center frequency.

Example: "FREQ:CENT:STEP 120MHz"

Characteristics: *RST value: - (AUTO 0.1 × SPAN is switched on)
SCPI: conform

Mode: R, A

[SENSe<1|2>:]FREQuency:CENTer:STEP:LINK SPAN | RBW | OFF

This command couples the step width of the center frequency to span (span >0) or to the resolution bandwidth (span = 0) or cancels the couplings.

Parameter: SPAN = Coupling to frequency display range (for span > 0)
RBW = Coupling to resolution bandwidth (for span = 0)
OFF = manual input, no coupling.

Example: "FREQ:CENT:STEP:LINK SPAN"

Characteristics: *RST value: SPAN
SCPI: device-specific

Mode: A

[SENSe<1|2>:]FREQuency:CENTer:STEP:LINK:FACTor 1 to 100 PCT

This command couples the step width of the center frequency with a factor to the span (span >0) or to the resolution bandwidth (span = 0).

Example: "FREQ:CENT:STEP:LINK:FACT 20PCT"

Characteristics: *RST value: - (AUTO 0.1 × SPAN is switched on)
SCPI: device-specific

Mode: A

[SENSe<1|2>:]FREQuency:SPAN 0 to f_{\max}

In analyzer mode, this command defines the frequency span.

Example: "FREQ:SPAN 10MHz"

Characteristics: *RST value: f_{\max} with f_{\max} = maximum frequency
SCPI: conform

Mode: A

[SENSe<1|2>:]FREQuency:SPAN:FULL

In analyzer mode, this command sets the frequency span to its maximum.

Example: "FREQ:SPAN:FULL"

Characteristics: *RST value: -
SCPI: conform

Mode: A

This command is an event and therefore has no *RST value and no query.

[SENSe<1|2>:]FREQuency:START 0 to f_{\max}

This command defines the start frequency of the overall scan in receiver mode. It defines the start frequency of the sweep in analyzer mode..

Example: "FREQ:STAR 20MHz"

Characteristics: *RST value: 0
SCPI: conform

Mode: R, A-F

[SENSe<1|2>:]FREQuency:STOP 0 to f_{\max}

This command defines the stop frequency of the overall scan in receiver mode. It defines the stop frequency of the sweep in analyzer mode..

Example: "FREQ:STOP 20MHz"

Characteristics: *RST value: f_{\max}
SCPI: conform

Mode: R, A-F

[SENSe<1|2>:]FREQuency:MODE CW | FIXEd | SWEep | SCAN

In analyzer mode, this command switches between frequency domain (SWEep) and time domain (CW | FIXEd).

In receiver mode, this command switches between single frequency measurement (CW) and scan (SCAN).

For CW and FIXEd, the frequency setting is made using the FREQuency:CENTer command. For SWEep, the setting is made using the FREQuency:START, STOP, CENTER and SPAN commands.

For SCAN, the frequency setting is made using the commands FREQuency:START, FREQuency:STOP in the SENSe:SCAN submenu.

Example: "FREQ:MODE SWE"

Characteristics: *RST value: SWEep for the analyzer mode and SCAN for the receiver mode
SCPI: conforming

Mode: R, A

[SENSe<1|2>:]FREQuency:OFFSet <numeric_value>

This command defines the frequency offset of the instrument.

Example: "FREQ:OFFS 1GHZ"

Characteristics: *RST value: 0 Hz
SCPI: conform

Mode: A

6.16.9 SENSe:LIST Subsystem

The commands of this subsystem are used for measuring the power at a list of frequency points with different device settings. The measurement is always performed in the time domain (span = 0 Hz).

A new trigger event is required for each test point (exception: Trigger FREE RUN).

The results are output as a list in the order of the entered frequency points. The number of results per test point depends on the number of concurrently active measurements (peak/RMS/average).

Selection of concurrently active measurements and setting of parameters that are constant for the whole measurement is via a configuration command (`SENSe:LIST:POWer:SET`). This also includes the setting for trigger and gate parameters.

The following setting parameters can be selected independently for each frequency point:

- Analyzer frequency
- Reference level
- RF attenuation
- Resolution filter
- Resolution bandwidth
- Video bandwidth
- Measurement time
- Detector

The number of frequencies is limited to 100 entries.

The commands of this subsystem can be used in two different ways:

1. Instrument setup, measurement and querying of the results in a single command:
With this method, there is the least delay between the measurement and the result output. However, it requires the control computer to wait for the response from the instrument.
2. Instrument setup and querying of the result list at the end of the measurement:
With this method, the control computer may be used for other activities while the measurement is being performed. However, more time is needed for synchronization via service request.



Settings that are not directly included in commands of this subsystem can be configured by sending the corresponding commands prior to the `SENSe:LIST` commands.

Please note that changes to the trigger level have to be executed in time domain (span = 0 Hz) in order to take effect for the `SENSe:LIST` commands.

[SENSe<1|2>:]LIST:POWer:RESult?

This command queries the result of a previous list measurement as configured and initiated with `SENSe:LIST:POWer[:SEQuence]`. The measured results are output in a list of floating point values separated by commas. The unit of the results depends on the setting made with the `CALC:UNIT` command.

This command may be used to obtain measurement results in an asynchronous way, using the service request mechanism for synchronization with the end of the measurement.

If no measurement results are available, the command will return a query error.

Example:

'Configuration of the status reporting system for the generation of an SRQ on operation complete

*ESE 1

*SRE 32

'Configuring and starting the measurement

```
"SENSe:LIST:POWer 935.2MHz,-20dBm,10dB,OFF,NORM,1MHz,3MHz,434us,0,
935.4MHz,-20dBm,10dB,OFF,NORM,30kHz,100kHz,434us,0,
935.6MHz,-20dBm,10dB,OFF,NORM,30kHz,100kHz,434us,0;
*OPC"
```

'Further actions of the control computer during measurement

to

'Response to service request

On SRQ:

```
SENSe:LIST:POWer:RESult?
```

Characteristics: *RST value: --
SCPI: device-specific

Mode: A

[SENSe<1|2>:]LIST:POWer[:SEQUENCE] <analyzer freq>,<ref level>,<rf att>,OFF, <el att>,<filter type>,<rbw>,<vbw>,<meas time>,<trigger level>

This command configures the list of settings (max. 100 entries) for the multiple power measurement and starts a measurement sequence. When synchronizing the command with *OPC, a service request is generated as soon as all frequency points are processed and the defined number of individual measurements is reached.

To reduce the setting time, all indicated parameters are set up simultaneously at each test point.

The query form of the command processes the list and immediately returns the list of results. The number of results per test point depends on the setting of the "SENSe:LIST:POWer:SET" command.



The following parameters are the settings for an individual frequency point. They are repeated for every other frequency point.

For reasons of compatibility with the FSP instrument family, input OFF is required after parameter <rf att>.

Parameter:

<analyzer freq>:	Receive frequency for the signal to be measured (= center frequency in manual operation)	
	Range of values:	0 Hz to max. frequency, depending on the instrument model.
<ref level>:	Reference level	
	Range of values:	+30 dBm to -75 dBm in 5 dB steps
<rf att>:	RF input attenuation	
	Range of values:	0 dB to 75 dB in 5 dB steps
OFF:	always OFF	

<filter type>:	NORMal:	normal resolution filter
	CFILter:	channel filter. These are especially steep-edged filters, which are used for example in Fast ACP measurement to ensure the band-limiting of a transmission channel in the time domain.
	RRC:	Root Raised Cosine filter. This special filter form is used to determine the channel power for some mobile radio standards.
<rbw>:	Resolution bandwidth	See filter table for <filter type> = CFILter and <filter type> = RRC. For possible combinations of filter type and filter bandwidth see table "List of available channel filters" in chapter "Instrument Functions", section "Setting the Bandwidths and Sweep Time – BW Key" on page 4.83.
<vbw>:	Video bandwidth	
	Range of values:	1 Hz to 10 MHz in 1, 3, 10 steps.
	The value is ignored for <filter type> = CFILter or RRC	
<meas time>:	Measurement time	
	Range of values:	1us to 30s
<trigger level>:	Reserved. Must be set to 0.	

For allowed <rbw> setting for <filter type> = CFILter and <filter type> = RRC see section "Setting the Bandwidths and Sweep Time – BW Key" - "List of Available Channel Filters" on page 4.89.

Return value:

The query command returns a list of comma-separated values (CSV) which contains the power measurement results in floating-point format. The unit depends on the setting with CALC:UNIT.

Command

```
"SENSe:LIST:POWer? 935.2MHz,-20dBm,10dB,OFF,NORM,1MHz,3MHz,434us,0,
935.4MHz,-20dBm,10dB,OFF,NORM,30kHz,100kHz,434us,0,
935.6MHz,-20dBm,10dB,OFF,NORM,30kHz,100kHz,434us,0"
```

thus returns the following list, for example:

```
-28.3,-30.6,-38.1
```

If the command sequence is extended to

```
"SENSe:LIST:POWer:SET ON,ON,ON,IMM,POS,0,0"
```

```
"SENSe:LIST:POWer? 935.2MHz,-20dBm,10dB,OFF,NORM,1MHz,3MHz,434us,0,
935.4MHz,-20dBm,10dB,OFF,NORM,30kHz,100kHz,434us,0,
935.6MHz,-20dBm,10dB,OFF,NORM,30kHz,100kHz,434us,0"
```

the result list is extended to 3 results per frequency point (peak, RMS and average):

```
-28.3,-29.6,1.5,-30.6,-31.9,0.9,-38.1,-40.0,2.3
```

Example:

```
"SENSe:LIST:POWer 935.2MHz,-20dBm,10dB,OFF,NORM,1MHz,3MHz,434us,0,
935.4MHz,-20dBm,10dB,OFF,CFIL,30kHz,100kHz,434us,0,
935.6MHz,-20dBm,10dB,OFF,CFIL,30kHz,100kHz,434us,0"
```

performs a measurement sequence with the following settings:

Step	Freq. [MHz]	Ref Level	RF Att	el Att	Filter type	RBW	VBW	Meas Time	TRG Level (reserved)
1	935.2	-20 dBm	10 dB	OFF	Normal	1 MHz	3 MHz	434 us	0

```
"SENSe:LIST:POWer? 935.2MHz,-20dBm,10dB,OFF,NORM,1MHz,3MHz,434us,0,
935.4MHz,-20dBm,10dB,OFF,CFIL,30kHz,100kHz,434us,0,
935.6MHz,-20dBm,10dB,OFF,CFIL,30kHz,100kHz,434us,0"
```

performs the same measurement and returns the result list immediately after the last frequency point.



- The measurement is performed in the time domain and therefore the span is set to 0 Hz. If the time domain is abandoned, the function is automatically switched off.
- The measurement is not compatible with other measurements, especially as far as marker, adjacent channel power measurement or statistics are concerned. The corresponding commands thus automatically deactivate the function.
- The function is only available in remote control. It is deactivated when switching the instrument back to LOCAL.

Characteristics: *RST value: --
SCPI: device-specific

Mode: A

[SENSe<1|2>:]LIST:POWer:SET <PEAK meas>,<RMS meas>,<AVG meas>,<trigger mode>,<trigger slope>,<trigger offset>,<gate length>

This command defines the constant settings for the list during multiple power measurement.

Parameters <PEAK meas>, <RMS meas> and <AVG meas> define, which measurements are to be performed at the same time at the frequency point. Correspondingly, one, two or three results per frequency point are returned for the `SENSe:LIST:POWer?` command. If all three parameters are set to OFF, the command generates an execution error.

Parameter:

- <PEAK meas>: ON activates the measurement of the peak power (peak detector). OFF deactivates the measurement of the peak power.
- <RMS meas>: ON activates the measurement of the RMS power (RMS detector). OFF deactivates the measurement of the RMS power.
- <AVG meas>: ON activates the measurement of the average power (average detector). OFF deactivates the measurement of the average power.
- <trigger mode>: Selection of the trigger source used for the list measurement.
Possible values: IMMEDIATE | VIDEO | EXTERNAL | IFFPower
- <trigger slope>: Used trigger slope.
Possible values: POSITIVE | NEGATIVE
- <trigger offset>: Offset between the detection of the trigger signal and the start of the measurement at the next frequency point.
Range of values: 0 s, 125 ns to 100s
- <gate length>: Gate length with Gated Sweep.
Range of values: 0 s, 125 ns to 100s



- The value 0 s deactivates the use of GATED TRIGGER; other values activate the GATED TRIGGER function.
- Values <> 0 s are only possible if <trigger mode> is different from IMMEDIATE. Otherwise, an execution error is triggered.

Return value: The query command returns a list of comma-separated values (CSV) of the settings, i.e.

ON,ON,ON,IMM,POS,0,0

if the configuration has been set with the command

"SENSe:LIST:POWer:SET ON,ON,ON,IMM,POS,0,0"

Example: "SENSe:LIST:POWer:SET ON,OFF,OFF,EXT,POS,10US,434US"

"SENSe:LIST:POWer:SET ON,ON,ON,VID,NEG,10US,0"

Characteristics: *RST values: ON,OFF,OFF,IMM,POS,0S,0S
SCPI: device-specific

Mode: A

[SENSe<1|2>:]LIST:POWer:SET:AVERAge:TYPE LINear | LOGarithmic

With this command the average type of the sense list measurement can be set either to linear (default) or logarithmic. In linear mode voltages are averaged in logarithmic mode levels.

Example: "LIST:POW:SET:AVER LOG"
'sets log averaging for list measurement.

Characteristics: *RST value: LIN
SCPI: device-specific

Mode: A

[SENSe<1|2>:]LIST:POWer:STATe OFF

This command deactivates the list measurement.

Example: "SENSe:LIST:POWer:STATe OFF"

Characteristics: *RST value: --
SCPI: device-specific

Mode: A

[SENSe<1|2>:]LIST:RANGe<1...20>:BANDwidth[:RESolution] <numeric_value>

This command selects the resolution bandwidth (RBW) of a range in the spurious measurement.

Example: "LIST:RANG2:BAND 10E3"
'Sets the RBW to 10 KHz.

Characteristics: *RST value: 10 kHz
SCPI: device-specific

Mode: A

[SENSe<1|2>:]LIST:RANGe<1...20>:BANDwidth:VIDeo <numeric_value>

This command selects the video bandwidth (VBW) of a range in the spurious measurement.

Example: "LIST:RANG2:BAND:VIDeo 40E3"
'Sets the VBW to 40 KHz.

Characteristics: *RST value: 30 kHz
SCPI: device-specific

Mode: A

[SENSe<1|2>:]LIST:RANGe<1...20>:BREak ON | OFF

This command determines whether a sweep is stopped in the spurious measurement when a range is changed.

Example: "LIST:RANG2:BRE ON"
'Sweep stops if the range is changed from range 2 to 3.

Characteristics: *RST value: OFF
SCPI: device-specific

Mode: A

[SENSe<1|2>:]LIST:RANGe<1...20>:COUNT?

This command indicates the number of defined ranges of the spurious measurement.

The numeric suffix <1 to 20> with RANGe is not relevant for this command.

Example: "LIST:RANG:COUN?"
'Indicates the number of ranges

Characteristics: *RST value: --
SCPI: device-specific

Mode: A

[SENSe<1|2>:]LIST:RANGe<1...20>:DELete

This command deletes a range.

Example: "LIST:RANG2:DEL"
'Deletes range 2

Characteristics: *RST value: --
SCPI: device-specific

Mode: A

[SENSe<1|2>:]LIST:RANGe<1...20>:DETector APEak | NEGative | POSitive | SAMPlE | RMS | AVERage

This command sets the detector in the spurious measurement.

Example: "LIST:RANG2:DET APE"
'Autoppeak detector

Characteristics: *RST value: POS
SCPI: device-specific

Mode: A

[SENSe<1|2>:]LIST:RANGe<1...20>:FILTer:TYPE NORMAL | CHANnel | RRC | PULSe

This command sets the filter in the spurious measurement. For details on filter type refer to chapter 4, section “Filter Types” on page 4.88.

Example: "LIST:RANG2:FILT:TYPE RRC"
'RRC filter

Characteristics: *RST value: NORMAL
SCPI: device-specific

Mode: A

[SENSe<1|2>:]LIST:RANGe<1...20>[:FREQUency]:START <numeric_value>

This command sets the start frequency of a range in the spurious measurement.

Example: "LIST:RANG2:STAR 1GHZ"
'Start frequency of range 2 to 1 GHz

Characteristics: *RST value: --
SCPI: device-specific

Mode: A

[SENSe<1|2>:]LIST:RANGe<1...20>[:FREQUency]:STOP <numeric_value>

This command sets the stop frequency of a range in the spurious measurement.

Example: "LIST:RANG2:STOP 2GHZ"
'Stop frequency of range 2 to 2 GHz

Characteristics: *RST value: --
SCPI: device-specific

Mode: A

[SENSe<1|2>:]LIST:RANGe<1...20>:INPut:ATTenuation <numeric_value>

This command defines the RF attenuation of a range in the spurious measurement.

Example: "LIST:RANG2:INP:ATT 30db"
'RF attenuation of range 2 to 30 dB

Characteristics: *RST value: -
SCPI: device-specific

Mode: A

[SENSe<1|2>:]LIST:RANGe<1...20>:INPut:ATTenuation:AUTO ON | OFF

This command switches the autoranging of a range in the spurious measurement on or off.

Example: "LIST:RANG2:INP:ATT:AUTO ON"
'Activates autorange for range 2

Characteristics: *RST value: ON
SCPI: device-specific

Mode: A

[SENSe<1|2>:]LIST:RANGe<1...20>:INPut:GAIN:STATe ON | OFF

This command switches the preamplifier of a range in the spurious measurement on or off.

Example: "LIST:RANG2:INP:GAIN:STAT ON"
'Activates the preamplifier for range 2

Characteristics: *RST value: OFF
SCPI: device-specific

Mode: A

[SENSe<1|2>:]LIST:RANGe<1...20>:LIMit -200dB to +200dB

This command defines the limit lines for the spurious emission measurement [LIST EVALUATION](#) (for details on this measurement see page 190). For each of the 20 ranges, you can specify a limit line via the numeric suffix at RANGe<1...20>. The numeric suffix at SENSe<1|2> is irrelevant.

Example: "LIST:RANG5:LIM -40"
'Limit line in range 5 is -40 dB.

Characteristics: *RST value: -13dB
SCPI: device-specific

Mode: A

[SENSe<1|2>:]LIST:RANGe<1...20>:LIMit:STATe ON | OFF

This command activates/deactivates the limit checking for the spurious emission measurement [LIST EVALUATION](#) (for details on this measurement see page 190).

The numeric suffix at SENSe<1|2> and the numeric suffix at RANGe1...20> are irrelevant.

Example: "LIST:RANG5:LIM -40"
'Limit line in range 5 is -40 dB.

"LIST:RANG7:LIM -20"
'Limit line in range 7 is -20 dB.

"LIST:RANG:LIM:STAT ON"
'Activates the limit checking in all ranges.

Characteristics: *RST value: OFF
SCPI: device-specific

Mode: A

[SENSe<1|2>:]LIST:RANGe<1...20>:POINTs <numeric_value>

This command defines the number of sweep points of a range in the spurious measurement.

Example: "LIST:RANG2:POIN 301"
'Sets 301 sweep points in range 2

Characteristics: *RST value: 625
SCPI: device-specific

Mode: A

[SENSe<1|2>:]LIST:RANGe<1...20>:RLEVel <numeric_value>

This command defines the reference level of a range in the spurious measurement.

Example: "LIST:RANG2:RLEV -30"
'Sets the reference level in range 2 to -30 dBm

Characteristics: *RST value: -
SCPI: device-specific

Mode: A

[SENSe<1|2>:]LIST:RANGe<1...20>:SWEep:TIME <numeric_value>

This command defines the sweep duration of a range in the spurious measurement.

Example: "LIST:RANG2:SWE:TIME 2.5MS"
'Sets the sweep time in range 2 to 2.5 ms

Characteristics: *RST value: --
SCPI: device-specific

Mode: A

[SENSe<1|2>:]LIST:RANGe<1...20>:SWEep:TIME:AUTO ON | OFF

This command controls the automatic coupling of the sweep duration on the frequency span and the bandwidth settings in a spurious measurement range.

Example: "LIST:RANG2:SWE:TIME:AUTO ON"
'Activates the coupling of frequency range and bandwidths in range 2

Characteristics: *RST value: ON
SCPI: device-specific

Mode: A

[SENSe<1|2>:]LIST:RANGe<1...20>:TRANsducer <string>

This command sets the transducer factor for a range in the spurious measurement.

Example: "LIST:RANG2:TRAN 'fac_1'"
'Sets the transducer factor fac_1 in range 2

Characteristics: *RST value: --
SCPI: device-specific

Mode: A

6.16.10 SENSe:MPOWER Subsystem

The commands of this subsystem are used to determine the mean burst power or peak burst power for a given number of signal bursts, and for outputting the results in a list. Since all the settings required for a measurement are combined in a single command, the measurement speed is considerably higher than when using individual commands.

For measuring the signal bursts, the GATED SWEEP function is used in the time domain. The gate is controlled either by an external trigger signal or by the video signal. An individual trigger event is required for each burst to be measured. In case of an external trigger, the R&S ESCI transfers the threshold value from the normal trigger settings (TRIG key). In case of a video signal or an IF signal, the threshold can be set separately.

If option R&S FSP-B6 is installed, you can also use an RF signal as trigger signal. The threshold can also be set separately.

If an external trigger signal is used, the threshold is adjusted to those of the normal trigger settings (TRIG key), while with a video signal the threshold can be set as desired.

The following graphics shows the relation between trigger time, trigger offset (for delayed gate opening) and measurement time.

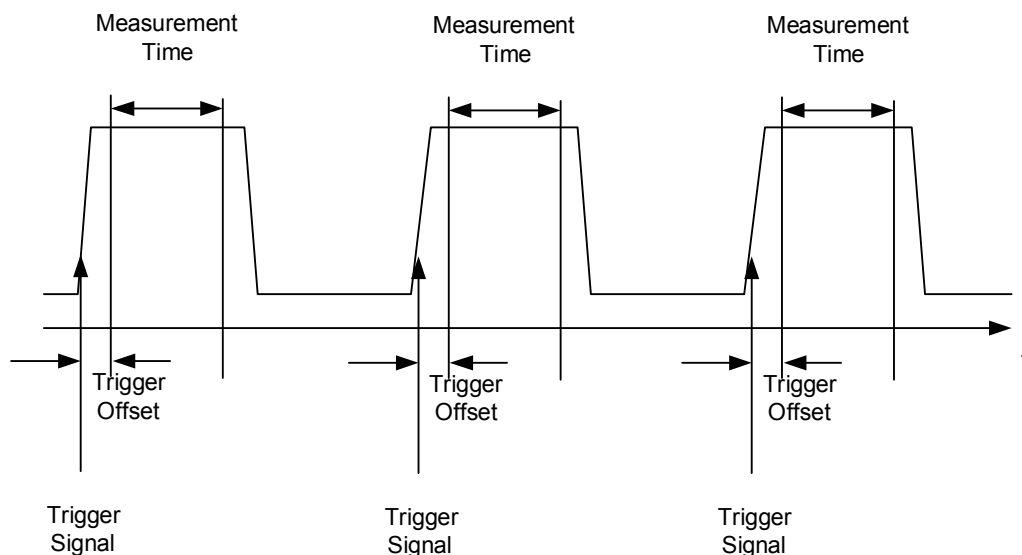

Depending on the settings made, the measurements are performed with the RMS detector for RMS power or the PEAK detector for peak power. For all these measurements, TRACE 1 of the selected system is used.

The setting parameters for this measurement are:

- analyzer frequency
- resolution bandwidth
- measurement time used for a single burst
- trigger source
- trigger level
- trigger offset
- type of power measurement (PEAK, MEAN)
- number of bursts to be measured

The commands of this subsystem can be used in two different ways:

1. Setting up the instrument and at the same time querying the result list:
This method ensures the smallest delay between measurement and the output of the measured values, but requires the control computer to wait actively for the response of the instrument.
2. Setting up the instrument and querying the result list after synchronization to the end of measurement:
With this method the control computer can be used for other activities while the instrument is performing the measurement at the cost of additional time needed for synchronization via service request.

[SENSe<1|2>:MPOWER:SEquence] <analyzer freq>,<rbw>,<meas time>,<trigger source>,<trigger level>,<trigger offset>,<type of meas>,<# of meas>

This command configures the instrument setup for multiple burst power measurement and starts a measurement sequence. When synchronizing the command with *OPC, a service request is generated as soon as the defined number of individual measurements (# of meas) is reached.

To reduce the setting time, the setup is performed simultaneously for all selected parameters.

The command in the form of a query makes the instrument settings, performs the defined number of measurements and outputs the measurement results list.

Parameter: <analyzer freq>

Receive frequency for the burst signals to be measured (= center frequency in manual operation) The range is 0 Hz to max. frequency, depending on instrument model

<rbw>

Resolution bandwidth for the measurement

The range is from 10 Hz to 10 MHz in steps of 1, 3, 10.

<meas time>

Time span during which measurement samples are sampled for RMS / peak measurement The type of measurement is selected by <type of meas>. The range is from 1 us to 30 s.

<trigger source>

Possible settings of the trigger signal source are:

EXTernal:

The trigger signal is fed from the "Ext. Trigger/Gate" input on the rear of the unit.

VIDeo:

The internal video signal is used as trigger signal.

IFPower:

The internal IF signal with 10 MHz bandwidth is used as the trigger signal.

RFPower:

If option R&S FSP-B6 is installed, the RF signal with a 80 MHz bandwidth is used as the trigger signal.

<trigger level>

Signal level at which the trigger becomes active.

For <trigger source> = VIDEo this is the level of the video signal as a percentage of the diagram height.

For <trigger source> = IFPower this is the signal level in dBm.

For <trigger source> = RFPower this is the signal level in dBm.

If <trigger source> = EXTeRnal is selected, the value entered here is ignored, as in this case the trigger input uses the normal trigger settings made via the TRIG key.

The range for trigger source video is 0 – 100PCT.

The range for trigger source IFPower is -50 dBm to +30 dBm.

The range for trigger source RFPower is -70 dBm to +30 dBm.



To properly use this command, you have to specify the unit of the trigger level (DBM or PCT).

<trigger offset>

Offset between the detection of the trigger signal and the start of the measurement. The range is from 125 ns to 100s

<type of meas>

Determines whether mean power (RMS) or peak power (PEAK) is to be measured. The detector is selected accordingly. Possible values are MEAN and PEAK.

<# of meas>

Number of individual bursts to be measured. The range is 1 to 501.

Return value: The query command returns a list separated by commas (comma separated values = CSV), which contains the power measurement results in floating-point format. The unit used for the return values is always dBm.

The command

"SENSe:MPOWer? 935.2MHz,1MHz,434us,VIDEO,50PCT,5us,MEAN,20" may, for instance, cause the following list to be returned:

18.3,18.6,18.1,18.0,17.9,18.3,18.6,18.1,18.0,17.9,18.3,18.6,18.1,18.0,17.9,18.3,18.6,18.1,18.0,17.9

Example: "SENSe:MPOWer 935.2MHz,1MHz,434us,VIDEO,50PCT,5us,MEAN,20"

'performs a measurement sequence with the following settings:

'Frequency = 935.2 MHz,

'Resolution bandwidth = 1 MHz

'Measurement time = 434 μ s

'Trigger source = VIDEO

'Trigger threshold = 50%

'Trigger offset = 5 μ s

'Type of measurement = MEAN power

'No. of measurements = 20

"SENSe:MPOWer? 935.2MHz,1MHz,434us,VIDEO,50PCT,5us,MEAN,20"

'performs the same measurement and in addition returns the results list immediately after completion of the last measurement.



The measurement function always uses trace 1 in the selected screen, and activates the selected screen.

Repeated use of the command without changes to its parameters (i.e. using the same settings again) will speed up the measurement since the previous hardware settings will be cached and therefore additional hardware settling times will be avoided. This also holds true if only part of the parameters (e.g. only the trigger delay) are changed, as in this case the rest of the parameters will be cached.

This measurement is not compatible with other measurements, especially as far as marker functions, adjacent channel measurement or statistics are concerned. The corresponding functions are therefore automatically switched off. In return incompatible commands will automatically deactivate the multi burst power function.

The function is only available in the remote control. It is deactivated on switching back to LOCAL.

If available also the RRC and the CFILer filter type can be used by defining it with the command "BAND|BWID:TYPE NORM | FFT | CFIL | RRC" before using the MPOW command.

Characteristics: *RST value: --
SCPI: instrument-specific

Mode: A-F, A-T

[SENSe<1|2>:]MPOWer:RESult[:LIST]?

This command queries the results of a multiple burst power measurement as configured and initiated with `SENSe:MPOWer[:SEQuence]`. The results are output in a comma-separated list of floating point values. The unit used for the return values is always dBm.

This command may be used to obtain measurement results in an asynchronous way using the service request mechanism for synchronization with the end of the measurement.

If no measurement results are available, the command will return a query error.

Example:

```
*ESE 1
*SRE 32
'Configuration of status reporting systems for the generation of an SRQ on
operation complete

SENSe:MPOWer
935.2MHz,1MHz,434us,VIDEO,50PCT,5us,MEAN,20;*OPC
'Configuring and starting the measurement

...
'Further actions of the control computer during measurement

On SRQ:
'Response to service request

SENSe:MPOWer:RESult?
```

Characteristics: *RST value: --
SCPI: instrument-specific

Mode: A-F, A-T

[SENSe<1|2>:]MPOWer:RESult:MIN?

This command queries the minimum power value in a multiple burst power measurement as configured and initiated with `SENSe:MPOWer[:SEquence]`. The unit used for the return values is always dBm.

If no measurement result is available, the command will return a query error.

Example:

```
*ESE 1
*SRE 32
'Configuration of status reporting systems for the generation of an SRQ on
operation complete

SENSe:MPOWer
935.2MHz,1MHz,434us,VIDEO,50PCT,5us,MEAN,20;*OPC
'Configuring and starting the measurement

...
'Further actions of the control computer during measurement

On SRQ:
'Response to service request

SENSe:MPOWer:RESult:MIN?
```

Characteristics: *RST value: --
SCPI: instrument-specific

Mode: A-F, A-T

6.16.11 SENSe:POWer Subsystem

This subsystem controls the setting of the instrument's channel and adjacent channel power measurements.

The measurement windows are selected by `SENSe1` (screen A) and `SENSe2` (screen B).

[SENSe<1|2>:]POWer:ACHannel:SPACing:CHANnel<1 to 11> 100 Hz to 2000 MHz

This command defines the channel spacing of the carriers. At the same time the spacing of carriers with higher channel number are set to the same value. If the spacing is equal between all carriers it is sufficient to set the spacing between carrier 1 and 2 with the command `SENS:POW:ACP:SPAC:CHAN1` or `SENS:POW:ACP:SPAC:CHAN`. If the spacing are set in ascending order individual spacing of the carriers can be set.

The command is available only for measurements in the frequency domain (span > 0).

Example:

```
"POW:ACH:SPAC:CHAN 25kHz"
'Sets the spacing between all carriers to 25 kHz

"POW:ACH:SPAC:CHAN2 4.8MHz"
'sets the spacing between TX carrier 2 and 3 to 4.8 MHz.
```

Characteristics: *RST value: 20 kHz
SCPI: device-specific

Mode: A-F

[SENSe<1|2>:]POWer:ACHannel:SPACing:ACHannel 100 Hz to 2000 MHz

This command defines the channel spacing of the adjacent channel to the TX channel. At the same time, the spacing of alternate adjacent channels 1 to 11 is set to the double or triple etc. of the entered value.

The command is only available in the frequency domain (span > 0).

Example: "POW:ACH:SPAC:ACH 33kHz"
 'Sets the spacing between the carrier signal and
 '- the adjacent channel to 33 kHz
 '- the alternate adjacent channel 1 to 66 kHz
 '- the alternate adjacent channel 2 to 99 kHz

Characteristics: *RST value: 14 kHz
 SCPI: device-specific

Mode: A-F

[SENSe<1|2>:]POWer:ACHannel:SPACing:ALTErnate<1 to 11> 100 Hz to 2000 MHz

This command defines the spacing between the alternate adjacent channels and the TX channel. If the spacing to an alternate adjacent channel ALTErnate<k> is modified, the spacing to all the following alternate adjacent channels ALTErnate<n> is set to (<n> + 1) / (<k> + 1) times the entered value.

This command is only available in the frequency domain (span > 0).

Example: "POW:ACH:SPAC:ALT1 100kHz"
 'Sets the spacing between TX channel and alternate adjacent channel 1 to 100 kHz
 and between TX channel and alternate adjacent channel 2 to 150 kHz.

Characteristics: *RST value:
 40 kHz (ALT1)
 60 kHz (ALT2)
 80 kHz (ALT3)
 100 kHz (ALT4)
 120 kHz (ALT5)
 140 kHz (ALT6)
 160 kHz (ALT7)
 180 kHz (ALT8)
 200 kHz (ALT9)
 220 kHz (ALT10)
 240 kHz (ALT11)
 SCPI: device-specific

Mode: A-F

[SENSe<1|2>:]POWer:ACHannel:TXChannel:COUNT 1 to 12

This command selects the number of carrier signals.

The command is available only for multi carrier channel and adjacent channel power measurements (CALC:MARK:FUNC:POW:SEL MCAC) in the frequency domain (span > 0).

Example: "POW:ACH:TXCH:COUN 3"

Characteristics: *RST value: 4
 SCPI: device-specific

Mode: A-F

[SENSe<1|2>:]POWer:ACHannel:ACPairs 0 to 12

This command sets the number of adjacent channels (upper and lower channel in pairs). The figure 0 stands for pure channel power measurement.

The command is only available in the frequency domain (span > 0).

Example: "POW:ACH:ACP 3"
'Sets the number of adjacent channels to 3, i.e. the adjacent channel and alternate adjacent channels 1 and 2 are switched on.

Characteristics: *RST value: 1
SCPI: device-specific

Mode: A-F

[SENSe<1|2>:]POWer:ACHannel:BANDwidth|BWIDth[:CHANnel] 100 Hz to 1000 MHz

This command sets the channel bandwidth of the radio communication system. The bandwidths of adjacent channels are not influenced by this modification (in contrast to the FSE family).

With `SENS:POW:HSP ON` the steep-edged channel filters from the table "List of available channel filters" in chapter "Instrument Functions", section "Setting the Bandwidths and Sweep Time – BW Key" on page 4.83 are available.

Example: "POW:ACH:BWID 30kHz"
'Sets the bandwidth of the TX channel to 30 kHz.

Characteristics: *RST value: 14 kHz
SCPI: device-specific

Mode: A-F

[SENSe<1|2>:]POWer:ACHannel:BANDwidth|BWIDth:ACHannel 100 Hz to 1000 MHz

This command defines the channel bandwidth of the adjacent channel of the radio transmission system. If the bandwidth of the adjacent channel is changed, the bandwidths of all alternate adjacent channels are automatically set to the same value.

With `SENS:POW:HSP ON` the steep-edged channel filters from the table "List of available channel filters" in chapter "Instrument Functions", section "Setting the Bandwidths and Sweep Time – BW Key" on page 4.83 are available.

Example: "POW:ACH:BWID:ACH 30kHz"
'Sets the bandwidth of all adjacent channels to 30 kHz.

Characteristics: *RST value: 14 kHz
SCPI: device-specific

Mode: A-F

[SENSe<1|2>:]POWer:ACHannel:BANDwidth|BWIDth:ALternate<1...11> 100 Hz to 1000 MHz

This command defines the channel bandwidth of the alternate adjacent channels of the radio transmission system. If the channel bandwidth of an alternate adjacent channel (e.g. channel no. 1) is changed, the bandwidth of all the following alternate adjacent channels (e.g. channels no. 2 to 11) is automatically set to the same value.

With `SENS:POW:HSP OFF`, the analog and FIR filters are available in the range from 10 Hz to 10 MHz.

With `SENS:POW:HSP ON` the steep-edged channel filters from the table "List of available channel filters" in chapter "Instrument Functions", section "Setting the Bandwidths and Sweep Time – BW Key" on page 4.83 are available.

Example: "POW:ACH:BWID:ALT2 30kHz"

Characteristics: *RST value: 14 kHz
SCPI: device-specific

Mode: A-F

[SENSe<1|2>:]POWer:ACHannel:FILTer:ALPHa:ALL 0...1

This command sets the rolloff factor of the RRC weighting filter for the TX channel, the adjacent channel and all alternate channels as well. It is only available if Fast ACP is not active and no predefined standard is selected. The query command is not supported..

Example: "POW:ACH:FILT:ALPH:ALL 0.26"
'sets Alpha to 0.26

Characteristics: *RST value: 0.26
SCPI: device-specific

Mode: A

[SENSe<1|2>:]POWer:ACHannel:FILTer:ALPHa:CHANnel<1...12> 0...1

This command sets the rolloff factor of the RRC weighting filter for the TX channel. It is only available if Fast ACP is not active and no predefine standard is selected.

Example: "POW:ACH:FILT:ALPH:CHAN 0.26"
'sets Alpha to 0.26

Characteristics: *RST value: 0.22
SCPI: device-specific

Mode: A

[SENSe<1|2>:]POWer:ACHannel:FILTer:ALPHa:ACHannel 0...1

This command sets the rolloff factor of the RRC weighting filter for the adjacent channel. It is only available if Fast ACP is not active and no predefine standard is selected.

This command changes the setting for the alternate channels as well.

Example: "POW:ACH:FILT:ALPH:ACH 0.26"
'sets Alpha to 0.26

Characteristics: *RST value: 0.22
SCPI: device-specific

Mode: A

[SENSe<1|2>:]POWer:ACHannel:FILTer:ALPHa:ALTErnate<1...11> 0...1

This command sets the rolloff factor of the RRC weighting filter for the alternate channels. It is only available if Fast ACP is not active and no predefine standard is selected.

This command changes the setting for the adjacent channel as well. The numeric suffixes at ALTErnate are irrelevant for this command.

Example: "POW:ACH:FILT:ALPH:ALT 0.26"
'sets Alpha to 0.26

Characteristics: *RST value: 0.22
SCPI: device-specific

Mode: A

[SENSe<1|2>:]POWer:ACHannel:FILTer:STATe:ALL ON | OFF

This command switches the weighing filter state for TX channel, adjacent channel and all alternate channels on or off. It is only available if Fast ACP is not active and no predefine standard is selected.

Example: "POW:ACH:FILT:STAT:ALL ON"
'activates weighting filters for all channels

Characteristics: *RST value: OFF
SCPI: device-specific

Mode: A

[SENSe<1|2>:]POWer:ACHannel:FILTer:STATe:CHANnel<1...12> ON | OFF

This command switches the weighing filter state for the TX channel on or off. It is only available if Fast ACP is not active and no predefine standard is selected.

This command changes the setting for the TX channel. The numeric suffix at CHANnel is ignored.

Example: "POW:ACH:FILT:STAT:CHAN ON"
'activates the weighting filter

Characteristics: *RST value: OFF
SCPI: device-specific

Mode: A

[SENSe<1|2>:]POWer:ACHannel:FILTer:STATe:ACHannel ON | OFF

This command switches the weighing filter state for the adjacent channel on or off. It is only available if Fast ACP is not active and no predefine standard is selected.

This command changes the setting for the alternate channels as well.

Example: "POW:ACH:FILT:STAT:ACH ON"
'activates the weighting filter

Characteristics: *RST value: OFF
SCPI: device-specific

Mode: A

[SENSe<1|2>:]POWer:ACHannel:FILTer:STATe:ALTeRnate<1 to 11> ON | OFF

This command switches the weighing filter state for the alternate channel on or off. It is only available if Fast ACP is not active and no predefine standard is selected.

This command changes the setting for all alternate channels and for the adjacent channel as well. The numeric suffixes at ALTeRnate are irrelevant for this command.

Example: "POW:ACH:FILT:STAT:ALT ON"
'activates weighting filter

Characteristics: *RST value: OFF
SCPI: device-specific

Mode: A

[SENSe<1|2>:]POWer:ACHannel:MODE ABSolute | RELative

This command toggles between absolute and relative adjacent channel measurement.

For the relative measurement the reference value is set to the currently measured channel power by command `SENSe:POWer:ACHannel:REFeRence:AUTO ONCE`.

The command is only available in the frequency domain (span > 0).

Example: `"POW:ACH:MODE REL"`

Characteristics: *RST value: ABSolute
SCPI: device-specific

Mode: A-F

[SENSe<1|2>:]POWer:ACHannel:PRESet:RLEVel:OFFSet 0 ... 100 dB

This command allows to modify the ADJUST REF LEVEL function for user standards. It defines an additional level offset to be taken into account for the analyzer's reference level setting. It is only available if Fast ACP is not active and no predefine standard is selected.

Example: `"POW:ACH:PRES:RLEV:OFFS 10dB"`
'set the level adjust offset to 10dB

Characteristics: *RST value: 0 dB
SCPI: device-specific

Mode: A

[SENSe<1|2>:]POWer:ACHannel:REFeRence:AUTO ONCE

This command sets the reference value for the relative measurement to the currently measured channel power.

The command is only available in the frequency domain (span > 0).

Example: `"POW:ACH:REF:AUTO ONCE"`

Characteristics: *RST value: -
SCPI: device-specific

Mode: A-F

This command is an event and therefore has no *RST value and no query.

[SENSe<1|2>:]POWer:ACHannel:REFeRence:TXChannel:AUTO MINimum | MAXimum | LHIGHest | OFF

This command activates or deactivates the automatic selection of a transmission channel to be used as a reference channel in relative adjacent channel power measurements.

The transmission channel with the highest power, the transmission channel with the lowest power, or the transmission channel nearest to the adjacent channels can be defined as a reference channel.

The command is available only for multi carrier channel and adjacent channel power measurements (`CALC:MARK:FUNC:POW:SEL MCAC`) in the frequency domain (span > 0).

Parameter: MINimum: Transmission channel with the lowest power
MAXimum: Transmission channel with the highest power
LHIGhest: Lowermost transmission channel for the lower adjacent channels,
uppermost transmission channel for the upper adjacent channels
OFF: Deactivates the automatic transmission channel selection.

Example: "POW:ACH:REF:TXCH:AUTO MAX"
'The transmission channel with the highest power is used as a reference channel.

Characteristics: *RST value: -
SCPI: device-specific

Mode: A-F

[SENSe<1|2>:]POWer:ACHannel:REference:TXCHannel:MANual 1 to 12

This command selects a transmission channel to be used as a reference channel in relative adjacent channel power measurements.

The command is available only for multi carrier channel and adjacent channel power measurements (CALC:MARK:FUNC:POW:SEL MCAC) in the frequency domain (span > 0).

Example: "POW:ACH:REF:TXCH:MAN 3"
'Transmission channel 3 is used as a reference channel.

Characteristics: *RST value: 1
SCPI: device-specific

Mode: A-F

[SENSe<1|2>:]POWer:ACHannel:PRESet ACPower | CPOWer | MCACpower | OBANdwidth | OBWidth | CN | CN0

This command adjusts the frequency span, the measurement bandwidths and the detector as required for the number of channels, the channel bandwidths and the channel spacings selected in the active power measurement. If necessary, adjacent channel power measurement is switched on prior to the adjustment.

To obtain valid results, a complete sweep with synchronization to the end of the sweep must be performed after the adjustment. Synchronization is possible only in the single-sweep mode.

The result is queried with the command CALCulate:MARKer:FUNction:POWer:RESult?.

The command is available only for measurements in the frequency domain (span > 0).

Example: "POW:ACH:PRES ACP"
'Sets the frequency span, the measurement bandwidths and the detector as required for the ACP measurement in screen A.

"INIT:CONT OFF"
'Switches over to single-sweep mode.

"INIT;*WAI"
'Starts a sweep and waits for the end of the sweep.

"CALC:MARK:FUNC:POW:RES? ACP"
'Queries the result of the adjacent channel power measurement.

Characteristics: *RST value: -
SCPI: device-specific

Mode: A-F

[SENSe<1|2>:]POWer:ACHannel:PRESet:RLEVel

This command adapts the reference level to the measured channel power and – if required - switches on previously the adjacent channel power measurement. This ensures that the signal path of the instrument is not overloaded. Since the measurement bandwidth is significantly smaller than the signal bandwidth in channel power measurements, the signal path can be overloaded although the trace is still significantly below the reference level. If the measured channel power equals the reference level, the signal path is not overloaded.

The command is only available in the frequency domain (span > 0).



Subsequent commands have to be synchronized with *WAI, *OPC or *OPC? to the end of the auto range process which would otherwise be aborted.

Example: "POW:ACH:PRESet:RLEV;*WAI"
'Adapts the reference level to the measured channel power.'

Characteristics: *RST value: -
SCPI: device-specific

Mode: A-F

[SENSe<1|2>:]POWer:BANDwidth|BWIDth 10 to 99.9PCT

This command defines the percentage of the power with respect to the total power. This value is the basis for the occupied bandwidth measurement (command: POWer:ACHannel:PRESet OBW).

The command is only available in the frequency domain (span > 0).

Example: "POW:BWID 95PCT"

Characteristics: *RST value: 99PCT
SCPI: device-specific

Mode: A-F

[SENSe<1|2>:]POWer:HSPeed ON | OFF

This command switches on or off the high-speed channel/adjacent channel power measurement. The measurement itself is performed in the time domain on the center frequencies of the individual channels. The command automatically switches to the time domain and back.

Depending on the selected mobile radio standard, weighting filters with $\sqrt{\cos}$ characteristic or very steep-sided channel filters are used for band limitation.

The command is only available in the frequency domain (span > 0).



If the high-speed power measurement is switched off, the complete channel/adjacent channel power measurement is switched off.

Example: "POW:HSP ON"

Characteristics: *RST value: OFF
SCPI: device-specific

Mode: A-F

[SENSe<1|2>:]POWer:NCORrection ON | OFF

This command switches on or off the correction of the instrument inherent noise for channel power measurement. On activating this function, a reference measurement of the instrument inherent noise is performed. The measured noise power is then subtracted from the power in the examined channel.

The instrument inherent noise is then re-determined after any change of the center frequency, resolution bandwidth, sweep time and level setting by repeating the reference measurement in the new instrument setting.

Example: "POW:NCOR ON"

Characteristics: *RST value: OFF
SCPI: device-specific

Mode: A

[SENSe<1|2>:]POWer:TRACe 1 to 3

This command assigns the channel/adjacent channel power measurement to the indicated trace in the selected measurement window. The corresponding trace must be active, i.e. its state must be different from blank.



The measurement of the occupied bandwidth (OBW) is performed on the trace on which marker 1 is positioned. To evaluate another trace, marker 1 must be positioned to another trace with `CALCulate:MARKer:TRACe`.

Example: "POW:TRAC 2"
'Assigns the measurement in screen A to trace 2.

"SENS2:POW:TRAC 3"
'Assigns the measurement in screen B to trace 3.

Characteristics: *RST value: -
SCPI: device-specific

Mode: A

6.16.12 SENSe:ROSCillator Subsystem

This subsystem controls the reference oscillator. The numeric suffix in SENSe is irrelevant for the commands of this subsystem.

[SENSe<1|2>:]ROSCillator:SOURce INTernal | EXTernal | EAUTO

This command controls selection of the reference oscillator.

INTernal	Uses the internal reference signal.
EXTernal	Uses the external reference signal.
EAUTO	Uses the external reference signal, but automatically switches to the internal reference signal, if no external reference signal is detected. Note that you have to change the reference source back to EXT and EAUT once the connection to the external reference is reestablished.

You can query the current status with [\[SENSe<1|2>:\]ROSCillator:SOURce:EAUTO?](#)

If the external reference oscillator is selected, the reference signal must be connected to the rear panel of the instrument.

As of firmware version 4.4x, you can you also select EAUTO. This parameter selects an external reference signal, but switches to the internal reference signal if no external reference is detected. If the external reference oscillator is selected (EXT | EAUT), the reference signal must be connected to the rear panel of the instrument.

The reference settings are not changed after a preset.

Example: "ROSC:SOUR EXT"

Characteristics: *RST value: –
SCPI: conform

Mode: R, A

*RST is not influencing this parameter.

[SENSe<1|2>:]ROSCillator:SOURce:EAUTO?

This command queries the current source of the reference signal, if the external reference source EXT (INT) is used. The command returns INT if the internal reference source is used and EXT for an external reference source.

This command is a query and therefore has no *RST value.

Example: "ROSC:SOUR:EAUT?"

Characteristics: *RST value: -
SCPI: device-specific

Mode: R, A

[SENSe<1|2>:]ROSCillator:EXTernal:FREQuency 1MHz to 20MHz

This command informs the instrument on the frequency of the external reference oscillator. This frequency is used as starting point for the synchronization of the internal reference frequencies.

The value of the external reference frequency (1 MHz to 20 MHz) is rounded in steps of 1 Hz.

Example: "ROSC:EXT:FREQ 5MHz"

Characteristics: *RST value: -
SCPI: conform

Mode: R, A

*RST is not influencing this parameter.

[SENSe<1|2>:]ROSCillator:EXTernal:PLL NORMal | WIDE

This command controls the PLL bandwidth used to synchronize with the external reference signal and is available only with an external reference frequency of 10 MHz. By default, it is set to NORMal.

NORMal Uses a PLL bandwidth of about 3 Hz

WIDE Uses a PLL bandwidth of about 30 Hz

This function requires a certain minimum board revision of the synthesizer board.

Example: "ROSC:EXT:PLL NORM"

Characteristics: *RST value: -
SCPI: device-specific

Mode: R, A

[SENSe<1|2>:]ROSCillator[:INTernal]:TUNe 0 to 4095

This command defines the value for the tuning of the internal reference oscillator.

The reference oscillator should be tuned only if an error has been detected in the frequency accuracy check. After rebooting the instrument, the factory-set reference frequency or the previously saved reference frequency is restored.



This command is only available at service level 1.

Example: "ROSC:TUN 128"

Characteristics: *RST value: -
SCPI: device-specific

Mode: R, A

[SENSe<1|2>:]ROSCillator[:INTernal]:TUNe:SAVe

This command saves the new value for the tuning of the internal reference oscillator. The factory-set value in the EEPROM is overwritten.



This command is only available at service level 1.

Example: "ROSC:TUN:SAV"

Characteristics: *RST value: -
SCPI: device-specific

Mode: R, A

6.16.13 SENSe:SCAN Subsystem

This subsystem controls the parameters for the receiver scan data.

The numeric suffix in [SENSe<1|2>:]SCAN selects the scan range. The measurement window is selected by SENSe1 (screen A) and SENSe2 (screen B).

[SENSe<1|2>:]SCAN<1 to 10>:STARt f_{\min} to f_{\max}

This command defines the start frequency of the selected receiver scan range.

Example: ":SCAN1:STAR 50kHz"
'Sets the start frequency of scan range 1 to 50 kHz

Characteristics: *RST value: 150 kHz (range1)
30 MHz (range2)
SCPI: device-specific

Mode: R

[SENSe<1|2>:]SCAN<1 to 10>:STOP f_{\min} to f_{\max}

This command defines the stop frequency of the selected receiver scan range.

Example: ":SCAN1:STOP 200kHz"
'Sets the stop frequency of scan range 1 to 200 kHz

Characteristics: *RST value: 30 MHz (range1)
1 GHz (range2)
SCPI: device-specific

Mode: R

[SENSe<1|2>:]SCAN<1 to 10>:STEP f_{\min} to f_{\max}

This command defines the step size for the frequency of the selected receiver scan range.

Example: ":SCAN1:STEP 100Hz"
'Sets the step size for the frequency of scan range 1 to 100 Hz

Characteristics: *RST value: 4 kHz (range 1)
40 kHz (range 2)
SCPI: device-specific

Mode: R

[SENSe<1|2>:]SCAN<1 to 10>:BANDwidth:RESolution f_{\min} to f_{\max}

This command defines the bandwidth for the selected receiver scan range.

Example: ":SCAN1:BAND:RES 1MHz"
'Sets the resolution bandwidth of scan range 1 to 1 MHz

Characteristics: *RST value: 9 kHz (range 1)
120 kHz (range 2)
SCPI: device-specific

Mode: R

[SENSe<1|2>:]SCAN<1 to 10>:TIME 33 μ s to 100 s

This command defines the measurement time of the receiver subscan.

Example: ":SCAN1:TIME 1 ms"
'Sets the measurement time of scan range 1 to 1 ms

Characteristics: *RST value: 1 ms (range 1)
100 μ s (range 2)
SCPI: device-specific

Mode: R

[SENSe<1|2>:]SCAN<1 to 10>:INPut:ATTenuation dB_{min} to dB_{max}

This command defines the RF attenuation for the selected receiver scan range.

Example: ":SCAN1:INP:ATT 30dB"
'Sets the input attenuation of scan range 1 to 30 dB

Characteristics: *RST value: 10 dB
SCPI: device-specific

Mode: R

[SENSe<1|2>:]SCAN<1 to 10>:INPut:ATTenuation:AUTO ON | OFF

This command switches on or off the autoranging function in the selected receiver scan range.

Example: ":SCAN1:INP:ATT:AUTO ON"
'Activates the auto ranging function for scan range 1

Characteristics: *RST value: OFF
SCPI: device-specific

Mode: R

[SENSe<1|2>:]SCAN<1 to 10>:INPut:GAIN[:STATE] ON | OFF

This command switches on or off the preamplifier in the selected receiver scan range.

Example: ":SCAN1:INP:GAIN:STAT ON"
'Activates the preamplifier for scan range 1

Characteristics: *RST value: OFF
SCPI: device-specific

Mode: R

[SENSe<1|2>:]SCAN<1 to 10>:INPut:GAIN:AUTO ON | OFF

This command includes the preamplifier in the autoranging function of the selected receiver scan range.

Example: ":SCAN1:INP:GAIN:AUTO ON"
'Includes the preamplifier in the autoranging function for scan range 1

Characteristics: *RST value: OFF
SCPI: device-specific

Mode: R

[SENSe<1|2>:]SCAN<1 to 10>:RANGes[:COUNT] 1 to 10

This command determines the number of ranges. With setting 0, the scan is performed using the current receiver settings and not the settings defined with commands `SENSe:SCAN:...`

Example: "`SCAN:RANG:COUN 3`"
 'Sets the number of ranges to 3

Characteristics: *RST value: 0
 SCPI: device-specific

Mode: R

6.16.14 SENSe:SWEep Subsystem

This subsystem controls the sweep parameters.

The measurement windows are selected by SENSe1 (screen A) and SENSe2 (screen B).

[SENSe<1|2>:]SWEep:TIME 33 μ s to 100 s (receiver) | 2,5 ms to 16000 s (frequency domain) | 1 μ s to 16000 s (time domain)

This command defines the receiver single scan or the analyzer sweep time.

For receiver single scan, the available time value range is 33 μ s to 100 s with a 2-digit resolution. For the average, RMS, and peak detector, the smallest possible measurement time depends on the bandwidth (see chapter "Instrument Functions", section "Setting the Measurement Time" on page 4.28).

The available sweep time values are different in the frequency domain (2,5 ms to 16000s with span > 0) and in the time domain (1 μ s to 16000 s with span = 0).

If SWEep:TIME is directly programmed, automatic coupling to resolution bandwidth and video bandwidth is switched off.

Example: "SWE:TIME 10s"

Characteristics: *RST value: - (analyzer; AUTO is set to ON)
100 ms (receiver)
SCPI: conform

Mode: R, A

[SENSe<1|2>:]SWEep:TIME:AUTO ON | OFF

This command controls the automatic coupling of the sweep time to the frequency span and bandwidth settings.

If SWEep:TIME is directly programmed, automatic coupling is switched off.

Example: "SWE:TIME:AUTO ON"
'Switches on the coupling to frequency span and bandwidths.

Characteristics: *RST value: ON
SCPI: conform

Mode: A

[SENSe<1|2>:]SWEep:COUNT 0 to 32767

This command defines the number of scans started with single scan in receiver mode,

In analyzer mode, this command defines the number of sweeps started with single sweep, which are used for calculating the average or maximum value. In average mode, the value 0 defines a continuous averaging of measurement data over 10 sweeps.

Example: "SWE:COUN 64"
'Sets the number of sweeps to 64.

"INIT:CONT OFF"
'Switches to single-sweep mode.

"INIT;*WAI"
'Starts a sweep and waits for its end.

Characteristics: *RST value: 0
SCPI: conform

Mode: R, A

[SENSe<1|2>:]SWEep:COUNT:CURRENT?

This query command returns the current number of started sweeps. A sweep count value should be set and the device should be in single-sweep mode. This command is a query and therefore has no *RST value.

Example:

```
"SWE:COUNT 64"
'Sets sweep count to 64

"INIT:CONT OFF"
'Switches to single-sweep mode

"INIT"
'Starts a sweep (without waiting for the sweep end!)

"SWE:COUN:CURR?"
'Queries the number of started sweeps
```

Characteristics: *RST value: --
SCPI: conform

Mode: R, A

[SENSe<1|2>:]SWEep:EGATe ON | OFF

This command switches on/off the sweep control by an external gate signal. If the external gate is selected the trigger source is automatically switched to EXTERNAL as well.

In case of measurement with external gate, the measured values are recorded as long as the gate is opened. There are two possibilities:

- The gate is edge-triggered ("SWEep:EGATe:TYPE EDGE"):
 - After detection of the set gate signal edge, the gate remains open until the gate delay (SWEep:EGATe:HOLDoff) has expired.
- The gate is level-triggered ("SWEep:EGATe:TYPE LEVEL"):
 - After detection of the gate signal, the gate remains open until the gate signal disappears.

A delay between applying the gate signal and the start of recording measured values can be defined with SWEep:EGATe:HOLDoff.

During a sweep the gate can be opened and closed several times. The synchronization mechanisms with *OPC, *OPC? and *WAI remain completely unaffected.

The sweep end is detected when the required number of measurement points (501 in analyzer mode) has been recorded.

Example:

```
"SWE:EGAT ON"
'Switches on the external gate mode.

"SWE:EGAT:TYPE EDGE"
'Switches on the edge-triggered mode.

"SWE:EGAT:HOLD 100US"
'Sets the gate delay to 100 µs.

"SWE:EGAT:LEN 500US"
'Sets the gate opening time to 500 µs.

"INIT;*WAI"
'Starts a sweep and waits for its end.
```

Characteristics: *RST value: OFF
SCPI: device-specific

Mode: A

[SENSe<1|2>:]SWEep:EGATe:TYPE LEVEL | EDGE

This command sets the type of triggering (level or edge) by the external gate signal.

The gate opening time cannot be defined with the parameter EGATe:LENGth in case of level triggering. The gate is closed when the gate signal disappears.

Example: "SWE:EGAT:TYPE EDGE"

Characteristics: *RST value: EDGE
SCPI: device-specific

Mode: A

[SENSe<1|2>:]SWEep:EGATe:POLarity POSitive | NEGative

This command determines the polarity of the external gate signal. The setting is valid both for the edge of an edge-triggered signal and the level of a level-triggered signal.

Example: "SWE:EGAT:POL POS"

Characteristics: *RST value: POSitive
SCPI: device-specific

Mode: A

[SENSe<1|2>:]SWEep:EGATe:HOLDoff 125 ns to 100 s

This command defines the delay time between the external gate signal and the continuation of the sweep.

Example: "SWE:EGAT:HOLD 100us"

Characteristics: *RST value: 0s
SCPI: device-specific

Mode: A

[SENSe<1|2>:]SWEep:EGATe:LENGth 0 to 100 s

In case of edge triggering, this command determines the time interval during which the instrument sweeps.

Example: "SWE:EGAT:LENG 10ms"

Characteristics: *RST value: 0s
SCPI: device-specific

Mode: A

[SENSe<1|2>:]SWEep:EGATe:SOURce EXTeRnal | IFPower | RFPower

This command toggles between external gate signal and IF power/RF power signal as a signal source for the gate mode. If an IF power signal is used, the gate is opened as soon as a signal at > -20 dBm is detected within the IF path bandwidth (10 MHz).



Selection RFPower is only available with option R&S FSP-B6 (TV and RF Trigger).

Example: "SWE:EGAT:SOUR IFP"
'Switches the gate source to IF power.

Characteristics: *RST value: IFPower
SCPI: device-specific

Mode: A

[SENSe<1|2>:]SWEep:EGATe:TRACe<1..3>COMMeNt

To enter a comment string in the gate range table.

The suffix after TRACe indicates the trace.

Example: "SWE:EGAT:TRAC2:COMMeNt"
'To enter a comment in trace 2.

Characteristics: *RST value: --
SCPI: device-specific

Mode: A

[SENSe<1|2>:]SWEep:EGATe:TRACe<1..3>STATe<1..3> ON | OFF

The gate range in the gate range table is set on or off.

The suffix after TRACe indicates the trace.

The suffix after STATe indicates the range.

Example: "SWE:EGAT:TRAC2:STAT1 ON"
'Range 1 for trace 2 is switched on.

Characteristics: *RST value: OFF
SCPI: device-specific

Mode: A

[SENSe<1|2>:]SWEep:EGATe:TRACe<1..3>STARt<1..3> | STOP<1..3> <value>

Sets the start or stop value of a gate range in the gate range table.

The suffix after TRACe indicates the trace.

The suffix after STARt | STOP indicates the range.

Example: "SWE:EGAT:TRAC1:STAR2 5us"
'Start value of range 2, trace 1 is set to 5 μ s.

Characteristics: *RST value: 1.797693135E+308
SCPI: device-specific

Mode: A

[SENSe<1|2>:]SWEep:EGATe:TRACe<1..3>PERiod <value>

The period of the signal is set for the gate range table.

The suffix after TRACe indicates the trace.

Example: "SWE:EGAT:TRAC1:PER 5ms"
'Period of trace 1 is set to 5 ms.'

Characteristics: *RST value: 1.797693135E+308
SCPI: device-specific

Mode: A

[SENSe<1|2>:]SWEep:MODE AUTO | LIST | ESpectrum

This command controls the sweep continuation.

AUTO free running sweep - the spurious list is activated

ESpectrum activates the Spectrum Emission Mask measurement

LIST Activates the spurious emissions measurement. The sweep list is defined using the SENS:LIST:RANGE commands.

Example: "SWE:MODE LIST"
Activates the spurious emissions measurement.

Characteristics: *RST value: AUTO
SCPI: device-specific

Mode: A

[SENSe<1|2>:]SWEep:POINts 125, 251, 501, 1001, 2001, 4001, 8001

This command defines the number of measurement points for one sweep run.

Example: "SWE:POIN 251"

Characteristics: *RST value: 501
SCPI: conform

Mode: A

[SENSe<1|2>:]SWEep:SPACing LINear | LOGarithmic | AUTO

In receiver mode, this command toggles between linear, logarithmic and automatic linear step modes. In receiver mode this setting does not influence the display of the frequency axis.

In analyzer mode, this command toggles between linear and logarithmic sweep. The frequency axis is set to linear or logarithmic scaling accordingly.

Example: "SWE:SPAC LOG"

Characteristics: *RST value: LIN
SCPI: conform

Mode: R, A

6.16.15 SENSe:TV Subsystem

This subsystem controls the TV trigger part of option R&S FSP-B6 (TV and RF trigger). The setup of the individual trigger parameters is included in subsystem TRIGger.

[SENSe<1|2>:]TV[:STATe] ON | OFF

This command switches triggering on TV signals on or off.

Example: "TV ON"

Characteristics: *RST value: OFF
SCPI: device-specific

Mode: A-T

This command is only available with option R&S FSP-B6 (TV and RF Trigger).

[SENSe<1|2>:]TV:CCVS INTernal | EXTernal

This command selects between an internal and an external CCVS signal as TV demodulator input signal.

Example: "TV:CCVS EXT"

Characteristics: *RST value: INT
SCPI: device-specific

Mode: A-T

This command is only available with option R&S FSP-B6 (TV and RF Trigger).

6.17 SOURce Subsystem

The SOURce subsystem controls the output signals of the instrument if the options tracking generator (B9) or External Generator Control (B10) are installed. The measurement window is selected by SOURce1 (screen A) and SOURce2 (screen B).

6.17.1 Internal Tracking Generator

SOURce<1|2>:AM:STATe ON | OFF

This command switches on or off the external amplitude modulation of the tracking generator in the selected measurement window.

External I/Q modulation is switched off, if active. This command is only valid in conjunction with the tracking generator option B9.

Example: "`SOUR:AM:STAT ON`"
 'Switches on the external amplitude modulation of the tracking generator for screen A.

Characteristics: *RST value: OFF
 SCPI: conform

Mode: R, A

SOURce<1|2>:DM:STATe ON | OFF

This command switches on or off the external I/Q modulation of the tracking generator in the selected measurement window.

External AM and external FM are switched off, if active. This command is only valid in conjunction with the tracking generator option B9.

Example: "`SOUR2:DM:STAT ON`"
 'Switches on the external I/Q modulation of the tracking generator for screen B.

Characteristics: *RST value: OFF
 SCPI: conform

Mode: R, A

SOURce<1|2>:FM:STATe ON | OFF

This command switches on or off the external frequency modulation of the tracking generator in the selected measurement window.

External I/Q modulation is switched off, if active. This command is only valid in conjunction with the tracking generator option B9.

Example: "`SOUR:FM:STAT ON`"
 'Switches on the external frequency modulation of the tracking generator for screen A.

Characteristics: *RST value: OFF
 SCPI: conform

Mode: R, A

SOURce<1|2>:FM:DEVIation 100Hz to 10MHz

This command defines the maximum frequency deviation at 1 V input voltage at the FM input of the tracking generator.

The possible value range is 100 Hz to 10 MHz in steps of one decade.

This command is only available in connection with the Tracking Generator Option B9.

Example: "`SOUR:FM:DEV 1MHz`"
 'Sets the maximum frequency deviation of the tracking generator for screen A to 1 MHz.

Characteristics: *RST value: 100 Hz
 SCPI: conform

Mode: R, A

SOURce<1|2>:FREQuency:OFFSet -150MHz to 150MHz

This command defines a frequency offset of the tracking generator for the indicated measurement window. Frequency-converting DUTs can be measured with this setting.

The possible value range is -150 MHz to 150 MHz. It should be noted that the terms (start frequency - tracking frequency offset) and (stop frequency - tracking frequency offset) are both > 1 kHz or both < -1 kHz.

External I/Q modulation is switched off, if active. This command is only valid in conjunction with the tracking generator option B9.

Example: "`SOUR:FREQ:OFFS 10MHz`"
 'Switches on the frequency offset of the tracking generator for screen A to 10 MHz.

Characteristics: *RST value: 0 Hz
 SCPI: conform

Mode: R, A

SOURce<1|2>:POWer[:LEVel][:IMMediate][:AMPLitude] <numeric_value>

This command defines the output level of the tracking generator in the current measurement window.

This command is only valid in conjunction with the tracking generator option B9.

Parameter: <numeric value> ::= -30 dBm to 0 dBm

Example: "`SOUR:POW -20dBm`"
 'Sets the tracking generator level in screen A to -20 dBm.

Characteristics: *RST value: -20 dBm
 SCPI: conform

Mode: R, A

SOURce<1|2>:POWER[:LEVel][:IMMediate]:OFFSet -200dB to +200dB

This command defines a level offset for the tracking generator level. Thus, for example, attenuators or amplifiers at the output of the tracking generator can be taken into account for the setting.

This command is only valid in conjunction with the tracking generator option B9.

Example: "`SOUR:POW:OFFS -10dB`"
 'Sets the level offset of the tracking generator in screen A to - 20 dBm.

Characteristics: *RST value: 0dB
 SCPI: conform

Mode: R, A

SOURce<1|2>:POWER:MODE FIXed | SWEep

This command activates or deactivates the power sweep. If the power sweep is ON the enhancement label TGPWR is shown and the R&S ESCI is set to zero span mode (span = 0Hz). During the sweep time of the zero span the power at the internal tracking generator is changed linear from start power to stop power. The start and stop power values are shown on the right side below the diagram

Example: "`SOUR:POW:MODE SWE`"
 'switches on the level sweep in screen A.

Characteristics: *RST value: FIX
 SCPI: conform

Mode: A

SOURce<1|2>:POWER:STARt -30 dBm to 0 dBm

This command defines the start power of the power sweep. The start value can be smaller than the start value.

Example: The start power can be set between -30 dBm and +0 dBm. "`SOUR:POW:STAR`
 `0dBm`"
 'sets the end level to 0 dBm in screen A.

Characteristics: *RST value: 0 dBm
 SCPI: conform

Mode: A

SOURce<1|2>:POWER:STOP -30 dBm to 0 dBm

This command defines the stop power of the power sweep. The stop power can be set between -30 dBm and +0 dBm. The stop value can be smaller than the start value.

Example: "`SOUR:POW:STOP 0dBm`"
 'sets the end level to 0 dBm in screen A.

Characteristics: *RST value: 0 dBm
 SCPI: conform

Mode: A

6.17.2 SOURce:EXtErnal Subsystem

The SOURce:EXtErnal subsystem controls the operation of the unit with option Ext. Generator Control (R&S FSP-B10). The commands are only valid for the selected window, with SOURce1 changing the setting in screen A and SOURce2 the setting in screen B.

The selection of the external generator 1 or 2 is via EXtErnal<1|2>.



The commands of the SOURce:EXtErnal subsystem assume that the addressed generator was correctly configured with the commands of subsystem SYSTem: COMMunicate: GPIB: RDEvice: GENerator.

If no external generator is selected, if the GPIB address is not correct or the generator is not ready for operation, an execution error will be generated.

SOURce<1|2>:EXtErnal<1|2>[:STATe] ON | OFF

This command activates or deactivates the external generator selected with SOUR:EXT<1|2>:FREQ:SWE ON in the selected window.

The suffix behind EXtErnal is irrelevant for this command.

This command is only available in connection with option Ext. Generator Control R&S FSP-B10.

Example:

```
"SYST:COMM:RDEV:GEN1:TYPE 'SMP02'"
'Selects SMP02 as generator 1.

"SYST:COMM:RDEV:GEN1:LINK TTL"
'Selects GPIB + TTL link as interface.

"SYST:COMM:RDEV:GEN1:ADDR 28"
'Sets the generator address to 28.

"SOUR:EXT1:FREQ:SWE ON"
'Activates the frequency sweep for generator 1.

"SOUR:EXT ON"
'Activates the external generator
```

Characteristics: *RST value: OFF
SCPI: device-specific

Mode: R, A

SOURce<1|2>:EXtErnal<1|2>:FREQUency[:FACTor]:DENominator <numeric_value>

This command defines the denominator of the factor with which the analyzer frequency is multiplied in order to obtain the transmit frequency of the selected generator 1 or 2 in the selected window.



Select the multiplication factor in a way that the frequency range of the generator is not exceeded by the following formula:

$$F_{\text{Generator}} = \left| F_{\text{Analyzer}} \cdot \frac{\text{Numerator}}{\text{Denominator}} + F_{\text{Offset}} \right|$$

if applied to the start and stop frequency of the analyzer.

This command is only valid in combination with option Ext. Generator Control R&S FSP-B10.

Example: "SOUR:EXT:FREQ:NUM 4"
 "SOUR:EXT:FREQ:DEN 3"
 'Sets a multiplication factor of 4/3, i.e. the transmit frequency of the generator is 4/3 times the analyzer frequency.

Characteristics: *RST value: 1
 SCPI: device-specific

Mode: R, A

SOURce<1|2>:EXTernal<1|2>:FREQUENCY[:FACTOR]:NUMerator <numeric_value>

This command defines the numerator of the factor with which the analyzer frequency is multiplied to obtain the transmit frequency of the selected generator 1 or 2 in the selected window.



Select the multiplication factor in a way that the frequency range of the generator is not exceeded by the following formula:

$$F_{\text{Generator}} = \left| F_{\text{Analyzer}} \cdot \frac{\text{Numerator}}{\text{Denominator}} + F_{\text{Offset}} \right|$$

if applied to the start and stop frequency of the analyzer.

This command is only valid in combination with option Ext. Generator Control R&S FSP-B10.

Example: "SOUR:EXT:FREQ:NUM 4"
 "SOUR:EXT:FREQ:DEN 3"
 'Sets a multiplication factor of 4/3, i.e. the transmit frequency of the generator is 4/3 times the analyzer frequency.

Characteristics: *RST value: 1
 SCPI: device-specific

Mode: R, A

SOURce<1|2>:EXTernal<1|2>:FREQUENCY:OFFSet <numeric_value>

This command defines the frequency offset of the selected generator 1 or 2 with reference to the receive frequency in the selected window.



Select the multiplication factor in a way that the frequency range of the generator is not exceeded by the following formula:

$$F_{\text{Generator}} = \left| F_{\text{Analyzer}} \cdot \frac{\text{Numerator}}{\text{Denominator}} + F_{\text{Offset}} \right|$$

if applied to the start and stop frequency of the analyzer.

This command is only valid in combination with option Ext. Generator Control R&S FSP-B10.

Example: "SOUR:EXT:FREQ:OFFS 1GHZ"
 'Sets a frequency offset of the generator transmit frequency compared to the analyzer receive frequency of 1 GHz.

Characteristics: *RST value: 0 Hz
 SCPI: device-specific

Mode: R, A

SOURce<1|2>:EXTernal<1|2>:FREQUency:SWEep[:STATe] ON | OFF

This command activates or deactivates the frequency sweep for generator 1 or 2 in the selected window.

This command is only valid in combination with option Ext. Generator Control R&S FSP-B10.

Example: "SOUR:EXT1:FREQ:SWE ON"
'Activates the frequency sweep for ext. generator 1.

Characteristics: *RST value: OFF
SCPI: device-specific

Mode: R, A

SOURce<1|2>:EXTernal<1|2>:POWer[:LEVel] <numeric_value>

This command sets the output power of the selected generator 1 or 2 in the selected window.

This command is only valid in combination with option Ext. Generator Control R&S FSP-B10.

Example: "SOUR:EXT:POW -30dBm"
'Sets the generator level to -30 dBm

Characteristics: *RST value: -20 dBm
SCPI: device-specific

Mode: R, A

SOURce<1|2>:EXTernal<1|2>:ROSCillator[:SOURce] INTernal | EXTernal

This command switches between external and internal reference oscillator for the frequency processing of external generator 1 and 2.

The command always works on both generators. Therefore, the numeric suffix in EXTernal<1|2> is not significant.

This command is only valid in combination with option Ext. Generator Control R&S FSP-B10.

Example: "SOUR:EXT:ROSC EXT"
'switches to external reference oscillator

Characteristics: *RST value: INT
SCPI: device-specific

Mode: R, A

6.18 STATus Subsystem

The STATus subsystem contains the commands for the status reporting system (see chapter “Remote Control – Basics”, section “Status Reporting System” on page 5.18). *RST does not influence the status registers.

STATus:OPERation[:EVENT]?

This command queries the contents of the EVENT section of the STATus:OPERation register. The contents of the EVENT section are deleted after readout.

Example: "STAT:OPER?"

Characteristics: *RST value: –
SCPI: conform

Mode: R, A

STATus:OPERation:CONDition?

This command queries the CONDition section of the STATus:OPERation register. Readout does not delete the contents of the CONDition section. The value returned reflects the current hardware status.

Example: "STAT:OPER:COND?"

Characteristics: *RST value: –
SCPI: conform

Mode: R, A

STATus:OPERation:ENABLE 0 to 65535

This command sets the bits of the ENABLE section of the STATus:OPERation register. The ENABLE register selectively enables the individual events of the associated EVENT section for the summary bit in the status byte.

Example: "STAT:OPER:ENAB 65535"

Characteristics: *RST value: –
SCPI: conform

Mode: R, A

STATus:OPERation:PTRansition 0 to 65535

This command sets the edge detectors of all bits of the STATus:OPERation register from 0 to 1 for the transitions of the CONDition bit.

Example: "STAT:OPER:PTR 65535"

Characteristics: *RST value: –
SCPI: conform

Mode: R, A

STATus:OPERation:NTRansition 0 to 65535

This command sets the edge detectors of all bits of the STATus:OPERation register from 1 to 0 for the transitions of the CONDition bit.

Example: "STAT:OPER:NTR 65535"

Characteristics: *RST value: –
SCPI: conform

Mode: R, A

STATus:PRESet

This command resets the edge detectors and ENABLE parts of all registers to a defined value. All PTRansition parts are set to FFFFh, i.e. all transitions from 0 to 1 are detected. All NTRansition parts are set to 0, i.e. a transition from 1 to 0 in a CONDition bit is not detected. The ENABLE part of the STATus:OPERation and STATus:QUESTionable registers are set to 0, i.e. all events in these registers are not passed on.

Example: "STAT:PRES"

Characteristics: *RST value: –
SCPI: conform

Mode: R, A

STATus:QUESTionable[:EVENT]?

This command queries the contents of the EVENT section of the STATus:QUESTionable register. The contents of the EVENT section are deleted after the readout.

Example: "STAT:QUES?"

Characteristics: *RST value: –
SCPI: conform

Mode: R, A

STATus:QUESTionable:CONDition?

This command queries the CONDition section of the STATus:QUESTionable register. Readout does not delete the contents of the CONDition section.

Example: "STAT:QUES:COND?"

Characteristics: *RST value: –
SCPI: conform

Mode: R, A

STATus:QUEStionable:ENABle 0 to 65535

This command sets the bits of the ENABle section of the STATus-QUEStionable register. The ENABle register selectively enables the individual events of the associated EVENt section for the summary bit in the status byte.

Example: "STAT:QUES:ENAB 65535"

Characteristics: *RST value: –
SCPI: conform

Mode: R, A

STATus:QUEStionable:PTRansition 0 to 65535

This command sets the edge detectors of all bits of the STATus:QUEStionable register from 0 to 1 for the transitions of the CONDition bit.

Example: "STAT:QUES:PTR 65535"

Characteristics: *RST value: –
SCPI: conform

Mode: R, A

STATus:QUEStionable:NTRansition 0 to 65535

This command sets the edge detectors of all bits of the STATus:QUEStionable register from 1 to 0 for the transitions of the CONDition bit.

Example: "STAT:QUES:NTR 65535"

Characteristics: *RST value: –
SCPI: conform

Mode: R, A

STATus:QUEStionable:POWer[:EVENt]?

This command queries the contents of the EVENt section of the STATus:QUEStionable:POWer register. Readout deletes the contents of the EVENt section.

Example: "STAT:QUES:POW?"

Characteristics: *RST value: –
SCPI: conform

Mode: R, A

STATus:QUEStionable:POWer:CONDition?

This command queries the contents of the CONDition section of the STATus:QUEStionable:POWer register. Readout does not delete the contents of the CONDition section.

Example: "STAT:QUES:POW:COND?"

Characteristics: *RST value: –
SCPI: conform

Mode: R, A

STATus:QUEStionable:POWer:ENABle 0 to 65535

This command sets the bits of the ENABle section of the STATus:QUEStionable:POWer register. The ENABle register selectively enables the individual events of the associated EVENt section for the summary bit.

Example: "STAT:QUES:POW:ENAB 65535"

Characteristics: *RST value: –
SCPI: conform

Mode: R, A

STATus:QUEStionable:POWer:PTRansition 0 to 65535

This command sets the edge detectors of all bits of the STATus:QUEStionable:POWer register from 0 to 1 for the transitions of the CONDition bit.

Example: "STAT:QUES:POW:PTR 65535"

Characteristics: *RST value: –
SCPI: conform

Mode: R, A

STATus:QUEStionable:POWer:NTRansition 0 to 65535

This command sets the edge detectors of all bits of the STATus:QUEStionable:POWer register from 1 to 0 for the transitions of the CONDition bit.

Example: "STAT:QUES:POW:NTR 65535"

Characteristics: *RST value: –
SCPI: conform

Mode: R, A

STATus:QUEStionable:LIMit<1|2> [:EVENt]?

This command queries the contents of the EVENt section of the STATus:QUEStionable:LIMit register. Readout deletes the contents of the EVENt section.

Example: "STAT:QUES:LIM?"

Characteristics: *RST value: –
SCPI: device-specific

Mode: R, A

STATus:QUEStionable:LIMit<1|2>:CONDition?

This command queries the contents of the CONDition section of the STATus:QUEStionable:LIMit register.

Readout does not delete the contents of the CONDition section.

Example: "STAT:QUES:LIM:COND?"

Characteristics: *RST value: –
SCPI: device-specific

Mode: R, A

STATus:QUEStionable:LIMit<1|2>:ENABle 0 to 65535

This command sets the bits of the ENABle section of the STATus:QUEStionable:LIMit register. The ENABle register selectively enables the individual events of the associated EVENT section for the summary bit.

Example: "STAT:QUES:LIM:ENAB 65535"

Characteristics: *RST value: –
SCPI: device-specific

Mode: R, A

STATus:QUEStionable:LIMit<1|2>:PTRansition 0 to 65535

This command sets the edge detectors of all bits of the STATus:QUEStionable:LIMit register from 0 to 1 for the transitions of the CONDition bit.

Example: "STAT:QUES:LIM:PTR 65535"

Characteristics: *RST value: –
SCPI: device-specific

Mode: R, A

STATus:QUEStionable:LIMit<1|2>:NTRansition 0 to 65535

This command sets the edge detectors of all bits of the STATus:QUEStionable:LIMit register from 1 to 0 for the transitions of the CONDition bit.

Example: "STAT:QUES:LIM:NTR 65535"

Characteristics: *RST value: –
SCPI: device-specific

Mode: R, A

STATus:QUEStionable:LMARgin<1|2>[:EVENT]?

This command queries the contents of the EVENT section of the STATus:QUEStionable:LMARgin register. Readout deletes the contents of the EVENT section.

Example: "STAT:QUES:LMAR?"

Characteristics: *RST value: –
SCPI: device-specific

Mode: R, A

STATus:QUEStionable:LMARgin<1|2>:CONDition?

This command queries the contents of the CONDition section of the STATus:QUEStionable:LMARgin register. Readout does not delete the contents of the CONDition section.

Example: "STAT:QUES:LMAR:COND?"

Characteristics: *RST value: –
SCPI: device-specific

Mode: R, A

STATus:QUESTionable:LMARgin<1|2>:ENABLE 0 to 65535

This command sets the bits of the ENABLE section of the STATus:QUESTionable:LMARgin register. The ENABLE register selectively enables the individual events of the associated EVENT section for the summary bit.

Example: "STAT:QUES:LMAR:ENAB 65535"

Characteristics: *RST value: –
SCPI: device-specific

Mode: R, A

STATus:QUESTionable:LMARgin<1|2>:PTRansition 0 to 65535

This command sets the edge detectors of all bits of the STATus:QUESTionable:LMARgin register from 0 to 1 for the transitions of the CONDition bit.

Example: "STAT:QUES:LMAR:PTR 65535"

Characteristics: *RST value: –
SCPI: device-specific

Mode: R, A

STATus:QUESTionable:LMARgin<1|2>:NTRansition 0 to 65535

This command sets the edge detectors of all bits of the STATus:QUESTionable:LMARgin register from 1 to 0 for the transitions of the CONDition bit.

Example: "STAT:QUES:LMAR:NTR 65535"

Characteristics: *RST value: –
SCPI: device-specific

Mode: R, A

STATus:QUESTionable:ACPLimit[:EVENT]?

This command queries the contents of the EVENT section of the STATus:QUESTionable:ACPLimit register. Readout deletes the contents of the EVENT section.

Example: "STAT:QUES:ACPL?"

Characteristics: *RST value: –
SCPI: device-specific

Mode: R, A

STATus:QUESTionable:ACPLimit:CONDition?

This command queries the contents of the CONDition section of the STATus:QUESTionable:ACPLimit register. Readout does not delete the contents of the CONDition section.

Example: "STAT:QUES:ACPL:COND?"

Characteristics: *RST value: –
SCPI: device-specific

Mode: R, A

STATus:QUESTionable:ACPLimit:ENABLE 0 to 65535

This command sets the bits of the ENABLE section of the STATus:QUESTionable:ACPLimit register. The ENABLE register selectively enables the individual events of the associated EVENT section for the summary bit.

Example: "STAT:QUES:ACPL:ENAB 65535"

Characteristics: *RST value: –
SCPI: device-specific

Mode: R, A

STATus:QUESTionable:ACPLimit:PTRansition 0 to 65535

This command sets the edge detectors of all bits of the STATus:QUESTionable:ACPLimit register from 0 to 1 for the transitions of the CONDition bit.

Example: "STAT:QUES:ACPL:PTR 65535"

Characteristics: *RST value: –
SCPI: device-specific

Mode: R, A

STATus:QUESTionable:ACPLimit:NTRansition 0 to 65535

This command sets the edge detectors of all bits of the STATus:QUESTionable:ACPLimit register from 1 to 0 for the transitions of the CONDition bit.

Example: "STAT:QUES:ACPL:NTR 65535"

Characteristics: *RST value: –
SCPI: device-specific

Mode: R, A

STATus:QUESTionable:FREQUency[:EVENT]?

This command queries the contents of the EVENT section of the STATus:QUESTionable:FREQUency register.

Example: "STAT:QUES:FREQ?"

Characteristics: *RST value: –
SCPI: device-specific

Mode: R, A

Readout deletes the contents of the EVENT section.

STATus:QUESTionable:FREQUency:CONDition?

This command queries the contents of the CONDition section of the STATus:QUESTionable:FREQUency register. Readout does not delete the contents of the CONDition section.

Example: "STAT:QUES:FREQ:COND?"

Characteristics: *RST value: –
SCPI: device-specific

Mode: R, A

STATus:QUEStionable:FREQuency:ENABle 0 to 65535

This command sets the bits of the ENABle section of the STATus:QUEStionable:FREQuency register. The ENABle register selectively enables the individual events of the associated EVENt section for the summary bit.

Example: "STAT:QUES:FREQ:ENAB 65535"

Characteristics: *RST value: –
SCPI: device-specific

Mode: R, A

STATus:QUEStionable:FREQuency:PTRansition 0 to 65535

This command sets the edge detectors of all bits of the STATus:QUEStionable:FREQuency register from 0 to 1 for the transitions of the CONDition bit.

Example: "STAT:QUES:FREQ:PTR 65535"

Characteristics: *RST value: –
SCPI: device-specific

Mode: R, A

STATus:QUEStionable:FREQuency:NTRansition 0 to 65535

This command sets the edge detectors of all bits of the STATus:QUEStionable:FREQuency register from 1 to 0 for the transitions of the CONDition bit.

Example: "STAT:QUES:FREQ:NTR 65535"

Characteristics: *RST value: –
SCPI: device-specific

Mode: R, A

STATus:QUEStionable:TRANsducer[:EVENt]?

This command queries the contents of the EVENt section of the STATus:QUEStionable:TRANsducer register. Readout deletes the contents of the EVENt section.

Example: "STAT:QUES:TRAN?"

Characteristics: *RST value: –
SCPI: device-specific

Mode: R, A

STATus:QUEStionable:TRANsducer:CONDition?

This command queries the contents of the CONDition section of the STATus:QUEStionable:FREQuency register. Readout does not delete the contents of the CONDition section.

Example: "STAT:QUES:TRAN:COND?"

Characteristics: *RST value: –
SCPI: device-specific

Mode: R, A

STATus:QUEStionable:TRANsducer:ENABle 0 to 65535

This command sets the bits of the ENABle section of the STATus:QUEStionable:TRANsducer register. The ENABle register selectively enables the individual events of the associated EVENt section for the sum bit in the status byte.

Example: "STAT:QUES:TRAN:ENAB 65535"

Characteristics: *RST value: –
SCPI: device-specific

Mode: R, A

STATus:QUEStionable:TRANsducer:PTRansition 0 to 65535

This command sets the edge detectors of all bits of the STATus:QUEStionable:TRANsducer register from 0 to 1 for the transitions of the CONDition bit.

Example: "STAT:QUES:TRAN:PTR 65535"

Characteristics: *RST value: –
SCPI: device-specific

Mode: R, A

STATus:QUEStionable:TRANsducer:NTRansition 0 to 65535

This command sets the edge detectors of all bits of the STATus:QUEStionable:TRANsducer register from 1 to 0 for the transitions of the CONDition bit.

Example: "STAT:QUES:TRAN:NTR 65535"

Characteristics: *RST value: –
SCPI: device-specific

Mode: R, A

STATus:QUEue[:NEXT]?

This command returns the earliest entry to the error queue and deletes it.

Positive error numbers indicate device-specific errors, negative error numbers are error messages defined by SCPI (cf. chapter "Error Messages"). If the error queue is empty, the error number 0, "no error", is returned. This command is identical with the command `SYSTEM:ERROR`.

Example: "STAT:QUE?"

Characteristics: *RST value: –
SCPI: conform

Mode: R, A

6.19 SYSTEM Subsystem

This subsystem contains a series of commands for general functions.

SYSTEM:COMMunicate:GPIB[:SELF]:ADDRESS 0 to 30

This command changes the GPIB address of the unit.

Example: "SYST:COMM:GPIB:ADDR 18"

Characteristics: *RST value: - (no influence on this parameter, factory default 20)
SCPI: conform

Mode: R, A

SYSTEM:COMMunicate:GPIB[:SELF]:RTERminator LFEOI | EOI

This command changes the GPIB receive terminator.

According to the standard the terminator in ASCII is <LF> and/or <EOI>. For binary data transfers (e.g. trace data) from the control computer to the instrument, the binary code (0AH) used for <LF> might be included in the binary data block, and therefore should not be interpreted as a terminator in this particular case. This can be avoided by changing the receive terminator to EOI.

Output of binary data from the instrument to the control computer does not require such a terminator change.

Example: "SYST:COMM:GPIB:RTER EOI"

Characteristics: *RST value: -- (no influence on this parameter, factory default LFEOI)
SCPI: device-specific

Mode: R, A

SYSTEM:COMMunicate:GPIB:RDEVice:GENerator<1|2>:ADDRESS 0 to 30

This command changes the GPIB address of the device selected as external generator 1 or 2.



If two generators are connected at the same time to IECBUS 2 their addresses must be different.

The command is only available with option Ext. Generator Control, R&S FSP-B10.

Example: "SYST:COMM:GPIB:RDEV:GEN1:ADDR 19"
' Changes the GPIB address of generator 1 to 19

Characteristics: *RST value: 28
SCPI: device-specific

Mode: R, A

SYSTEM:COMMunicate:GPIB:RDEvice:COMMand 0...30,<'command string'>

This command sends a command or query string to the external generator connected via the GPIB interface of the Ext. Generator Control, R&S FSP-B10. Usually an external generator is connected to this interface.



Only basic I/O is possible.

The first parameter is the GPIB address of the device connected with GPIB interface of option FSP-B10.

The command is only available with option Ext. Generator Control, R&S FSP-B10.

Parameter: 0...30: GPIB address of the external generator connected via the GPIB interface of the Ext. Generator Control, R&S FSP-B10. In the following example, the GPIB address is 18.

```
"SYST:COMM:GPIB:RDEF:COMM 18, '*RST'"
'Resets generator.
```

```
"SYST:COMM:GPIB:RDEF:COMM 18, 'SOURCE:FREQ:CW 2E9'"
'Sets generator frequency to 2 GHz.
```

```
"SYST:COMM:GPIB:RDEF:COMM 18, 'SOUR:POW 0'"
'Sets generator power to 0dBm.
```

```
"SYST:COMM:GPIB:RDEF:COMM? 18, 'SENS:POW?'"
'Queries the generator power.
```

Characteristics: *RST value: -
SCPI: device-specific

Mode: R, A

SYSTEM:COMMunicate:RDEvice:GENerator<1|2>:LINK GPIB | TTL

This command selects the interface type of the external generator 1 or 2. The following types are available

- GPIB alone (= GPIB, for all the generators of other manufacturers and some Rohde & Schwarz units)
- GPIB and TTL interface for synchronization (= TTL, for most of the Rohde & Schwarz generators, see table in command `SYSTEM:COMMunicate:RDEvice:GENerator:TYPE`).

The difference between the two operating modes is the execution speed. While, during GPIB operation, each settable frequency is transmitted separately to the generator, a whole frequency list can be programmed in one go if the TTL interface is also used. Frequency switching can then be performed per TTL handshake which results in considerable speed advantages.



Only one of the two generators can be operated via the TTL interface at a time. The other generator must be configured for GPIB.

The command is only available with option Ext. Generator Control, R&S FSP-B10.

Example: `"SYST:COMM:RDEV:GEN:LINK TTL"`
'Selects GPIB + TTL interface for generator operation

Characteristics: *RST value: GPIB
SCPI: device-specific

Mode: R, A

SYSTem:COMMunicate:RDEvice:GENerator<1|2>:TYPE <name>

This command selects the type of external generator 1 or 2. For a list of the available generator types including the associated interface, see chapter “External Generator Control – Option R&S FSP-B10”, section “List of Generator Types Supported by the R&S ESCI” on page 4.311.



Generators with TTL interface can also be operated via GPIB alone.

With NONE selected, the corresponding generator 1 or 2 is deactivated.

The command is only available with option Ext. Generator Control, R&S FSP-B10.

Example: "SYST:COMM:RDEV:GEN2:TYPE 'SME02'"
'Selects SME02 as generator 2.'

Characteristics: *RST value: NONE
SCPI: device-specific

Mode: R, A

SYSTem:COMMunicate:SERial:CONTrol:DTR IBFull | OFF

SYSTem:COMMunicate:SERial:CONTrol:RTS IBFull | OFF

These commands switch the hardware handshake procedure for the serial interface off (OFF) or on (IBFull).

The two commands are equivalent.

Example: "SYST:COMM:SER:CONT:DTR OFF"
"SYST:COMM:SER:CONT:RTS IBF"

Characteristics: *RST value: -- (no influence on this parameter, factory default OFF)
SCPI: conform

Mode: R, A

SYSTem:COMMunicate:SERial[:RECeive]:BAUD 110 | 300 | 600 | 1200 | 2400 | 9600 | 19200 | 38400 | 57600 | 115200 | 128000

This command sets the transmission speed for the serial interface (COM).

Example: "SYST:COMM:SER:BAUD 2400"

Characteristics: *RST value: -- (no influence on this parameter, factory default 9600)
SCPI: conform

Mode: R, A

SYSTem:COMMunicate:SERial[:RECeive]:BITS 7 | 8

This command defines the number of data bits per data word for the serial interface (COM).

Example: "SYST:COMM:SER:BITS 7"

Characteristics: *RST value: -- (no influence on this parameter, factory default 8)
SCPI: conform

Mode: R, A

SYSTEM:COMMunicate:SERial[:RECeive]:PARity[:TYPE] EVEN | ODD | NONE

This command defines the parity check for the serial interface (COM).

Parameter: EVEN: even parity
ODD: odd parity
NONE: no parity check.

Example: "SYST:COMM:SER:PAR EVEN"

Characteristics: *RST value: -- (no influence on this parameter, factory default NONE)
SCPI: conform

Mode: R, A

SYSTEM:COMMunicate:SERial[:RECeive]:SBITs 1|2

This command defines the number of stop bits per data word for the serial interface (COM).

Example: "SYST:COMM:SER:SBITs 2"

Characteristics: *RST value: -- (no influence on this parameter, factory default 1)
SCPI: conform

Mode: R, A

SYSTEM:COMMunicate:SERial[:RECeive]:PACE XON | NONE

This command switches on or off the software handshake for the serial interface.

Example: "SYST:COMM:SER:PACE XON"

Characteristics: *RST value: -- (no influence on this parameter, factory default NONE)
SCPI: conform

Mode: R, A

SYSTEM:COMMunicate:PRINter:ENUMerate:FIRSt?

This command queries the name of the first printer (in the list of printers) available under Windows NT.

The names of other installed printers can be queried with command `SYSTEM:COMMunicate:PRINter:ENUMerate:NEXT?`.

If no printer is configured an empty string is output.

Example: "SYST:COMM:PRIN:ENUM:FIRS?"

Characteristics: *RST value: NONE
SCPI: device-specific

Mode: R, A

SYSTEM:COMMunicate:PRINter:ENUMerate:NEXT?

This command queries the name of the next printer installed under Windows NT.

The command `SYSTEM:COMMunicate:PRINter:ENUMerate:FIRSt?` should be sent previously to return to the beginning of the printer list and query the name of the first printer.

The names of other printers can then be queried with `NEXT?`. After all available printer names have been output, an empty string enclosed by quotation marks (") is output for the next query. Further queries are answered by a Query Error.

Example: `"SYST:COMM:PRIN:ENUM:NEXT?"`

Characteristics: *RST value: NONE
SCPI: device-specific

Mode: R, A

SYSTEM:COMMunicate:PRINter:SElect <1|2> <printer_name>

This command selects one of the printers configured under Windows NT including the associated output destination.

The specified printer name must be a string as returned by the commands

`SYSTEM:COMMunicate:PRINter:ENUMerate:FIRSt?` or

`SYSTEM:COMMunicate:PRINter:ENUMerate:NEXT?`



Command `HCOPY:DESTination` is used to select an output medium other than the default one.

Example: `"SYST:COMM:PRIN:SEL 'LASER on LPT1'"`

Characteristics: *RST value: NONE
SCPI: device-specific

Mode: R, A

SYSTEM:DATE 1980 to 2099, 1 to 12, 1 to 31

This command is used to enter the date for the internal calendar.

The sequence of entry is year, month, day.

Example: `"SYST:DATE 2000,6,1"`

Characteristics: *RST value: –
SCPI: conform

Mode: R, A

SYSTem:DISPlay:FPANel ON | OFF

This command activates or deactivates the display of the front panel keys on the screen.

With the display activated, the instrument can be operated on the screen using the mouse by pressing the corresponding buttons. This may be useful if the instrument is operated in a detached station by means of a remote program such as PCANYWHERE.



With the display of the front panel keys activated, the screen resolution of the unit is set to 1024x768. Thus, only a section of the whole screen is visible on the internal LCD display, which will be moved by mouse moves.

For a full display of the user interface, an external monitor has to be connected to the rear panel.

When the front panel display is deactivated, the original screen resolution is restored.

Example: "SYST:DISP:FPAN ON"

Characteristics: *RST value: OFF
SCPI: device-specific

Mode: R, A

SYSTem:DISPlay:UPDate ON | OFF

This command switches on or off the update of all display elements during remote control.



The best performance is obtained when the display output is switched off during remote control.

Example: "SYST:DISP:UPD ON"

Characteristics: *RST value: OFF
SCPI: device-specific

Mode: R, A

SYSTem:ERRor?

This command queries the earliest entry in the error queue, and deletes it after the readout.

Positive error numbers indicate device-specific errors, negative error numbers are error messages defined by SCPI (cf. chapter "Error Messages"). If the error queue is empty, the error number 0, "no error", is returned. This command is identical with the command `STATus:QUEue:NEXT?`.

This command is a query and therefore has no *RST value.

Example: "SYST:ERR?"

Characteristics: *RST value: –
SCPI: conform

Mode: R, A

SYSTEM:ERRor:LIST?

This command reads all system messages and returns a list of comma separated strings. Each string corresponds to an entry in the table SYSTEM MESSAGES.

If the error list is empty, an empty string "" will be returned.

This command is a query and therefore has no *RST value.

Example: "SYST:ERR:LIST?"

Characteristics: *RST value: –
SCPI: device-specific

Mode: R, A

SYSTEM:ERRor:CLEar:ALL

This command deletes all entries in the table SYSTEM MESSAGES.

This command is an event and therefore has no query and no *RST value.

Example: "SYST:ERR:CLE:ALL?"

Characteristics: *RST value: –
SCPI: device-specific

Mode: R, A

SYSTEM:FIRMware:UPDate <path>

This command starts a firmware update using the data set in the selected directory. Beforehand, the update files have to be stored in the following subdirectories using command `MMEM:DATA:`

Directory	Contents
DISK1	disk1.bin
DISK2	data3.cab
DISK3	data4.cab
.....
DISK<n>	data<n+1>.cab

Example: "SYST:FIRM:UPD 'D:\USER\FWUPDATE'"
'Starts the firmware update from directory D:\USER\FWUPDATE using the files of subdirectories DISK1 to DISK11

Characteristics: *RST value: –
SCPI: device-specific

Mode: R, A

This command is an 'event' and therefore has no query and no *RST value.

SYSTEM:HPCoupling FSP | HP

This command controls the default coupling ratios Span/RBW and RBW/VBW for HP emulation mode. In case of FSP the standard parameter coupling of the instrument is used. As a result in most cases a shorter sweep time is used than in case of HP. This command can only be selected in the HP emulation mode.

Parameter: FSP: Use the instrument's default coupling ratios for span and resolution bandwidth (Span/RBW) and for resolution bandwidth and video bandwidth (RBW/VBW)

HP: Origin HP coupling ratios

Example: "SYST:LANG '8566B'"
'Switches the HP emulation on

"SYST:HPC HP"
'Uses HP coupling ratios

Characteristics: *RST value: FSP
SCPI: device-specific

Mode: A

SYSTEM:IDENTify:FACTory

This command resets the *IDN string to the factory default.

Return value: "1" for the factory default state
"0" for a changed *IDN string

Example: "SYST:IDEN:FACT"
'Sets the ID string to the factory default.

Characteristics: *RST value: –
SCPI: device-specific

Mode: R, A

SYSTEM:IFGain:MODE NORMal | PULSe

This command switches the 10 dB overload reserve on or off.

This command can only be selected in the HP emulation mode.

Parameter: NORM: switches the overload reserve off
PULSe: switches the overload reserve on

Example: "SYST:LANG '8566B'"
'Switches the HP emulation on
"SYST:IFG:MODE PULS"
'Switches the overload reserve on

Characteristics: *RST value: –
SCPI: device-specific

Mode: A

SYSTem:KLOCK ON | OFF

The alias remote command SYST:KLOC can be used to activate the LLO (local lockout) or to return to the local mode (GTL go to local). Parameter ON is LLO, OFF is GTL.

Example: "SYST:KLOC ON"
'activates LLO

Characteristics: *RST value: OFF
SCPI: device-specific

Mode: A

SYSTem:LANGUage 'SCPI' | '71100C' | '71200C' | '71209A' | '8560E' | '8561E' | '8562E' | '8563E' | '8564E' | '8565E' | '8566A' | '8566B' | '8568A' | '8568A_DC' | '8568B' | '8568B_DC' | '8591E' | '8594E'

This command activates the emulation of various analyzers. The analyzer default command set is SCPI.

The following remote-control languages are available:

SCPI, 71100C, 71200C, 71209A, 8560E, 8561E, 8562E, 8563E, 8564E, 8565E, 8566A, 8566B, 8568A, 8568A_DC, 8568B, 8568B_DC, 8591E, 8594E



- When SCPI is selected, the 8566B/8568B/8594E command set is available in addition.
- When 8566A, 8566B, 8568A or 8568B is selected, both command sets A and B are available, as far as they are supported.
- The HP model 8591E is compatible to HP model 8594E, the HP models 71100C, 71200C, and 71209A are compatible to HP models 8566A/B.

The settings or changes made on switching between remote-control languages are described in the Quick Start Guide, chapter 2.



Notes regarding switch over to 8566A/B and 8568A/B:

- Commands IP and KST, too, will perform the settings for the "# of Trace Points", "Start Freq.", "Stop Freq." and "Input Coupling".
- Switch over of the "# of Trace Points" will not take place until the instrument is switched to the remote control mode. For manual operation (selected with LOCAL softkey), the number of sweep points (trace points) will always be set to 1251.
- In the remote control mode, the screen area for the measurement will be reduced. The LOCAL softkey (lowermost softkey) will be shifted slightly towards the center of the screen.

Example: "SYST:LANG 'SCPI'"

Characteristics: *RST value: 'SCPI'
SCPI: conform

Mode: R, A

There is no query for this command.

SYSTEM:PASSword[:CENable] 'password'

This command enables access to the service functions by means of the password.

Example: "SYST:PASS 'XXXX'"

Characteristics: *RST value: –
SCPI: conform

Mode: R, A

This command is an event and therefore has no *RST value and no query.

SYSTEM:PRESet

This command initiates an instrument reset.

The effect of this command corresponds to that of the *PRESET* key with manual operation or to the *RST command.

Example: "SYST:PRES"

Characteristics: *RST value: –
SCPI: conform

Mode: R, A

SYSTEM:PRESet:COMPAtible FSP | OFF

This command specifies the preset compatibility.

Parameter: OFF: Mixed mode is set as preset mode.
FSP: Analyzer mode is set as preset mode.

Example: "SYST:PRES:COMP FSP"

Characteristics: *RST value: OFF
SCPI: device-specific

Mode: R, A

SYSTEM:SPEaker:VOLume 0 to 1

This command sets the volume of the built-in loudspeaker for demodulated signals. Minimum volume is set by 0 and maximum volume by 1.

The value 0 is the lowest volume, the value 1 the highest volume.

Example: "SYST:SPE:VOL 0.5"

Characteristics: *RST value: 0
SCPI: device-specific

Mode: R, A

SYSTEM:TIME 0 to 23, 0 to 59, 0 to 59

This command sets the internal clock. The sequence of entry is hour, minute, second.

Example: "SYST:TIME 12,30,30"

Characteristics: *RST value: –
SCPI: conform

Mode: R, A

SYSTEM:VERSion?

This command queries the number of the SCPI version, which is relevant for the instrument.

Example: "SYST:VERS?"

Characteristics: *RST value: –
SCPI: conform

Mode: R, A

This command is a query and therefore has no *RST value.

SYSTEM:MSIZe? MBOard

This command outputs the memory size of the mainboard.

Parameter:

MBOard Mainboard

Example: "SYST:MSIZ? MBO"
Outputs the memory size of the mainboard.

Characteristics: *RST value: --
SCPI: device-specific

Mode: R, A

SYSTEM:RSW: ON | OFF

This command controls a repeated sweep of the E1 and MKPK HI HP model commands. If the repeated sweep is OFF, the marker is set without sweeping before.

Example: "SYST:RSW:ON"
'Sets the repeated sweep on.

Characteristics: *RST value: --
SCPI: device-specific

Mode: R, A

6.20 TRACe Subsystem

The TRACe subsystem controls access to the instrument's internal trace memory.

6.20.1 General Trace Commands

TRACe[:DATA] TRACE1 | TRACE2 | TRACE3 | SINGLE | PHOLd | SCAN | STATus | FINAL1 | FINAL2 | FINAL3 | LIST | SPURious, <block> | ABITstream | <numeric_value>

This command transfers trace data from the control computer to the instrument, the query reads trace data out of the instrument.

Programming trace data to the instrument is available in spectrum analyzer mode.

The numeric suffix at TRACe<1|2> selects the measurement window.



If the FM demodulator (option R&S FS-K7) is active, only the displayed trace data is read out and recalled. A portion of the measurement data that can be called by means of a marker, however, is calculated from the raw measurement data. These results are no longer available after recalling a trace; the associated queries generate a query error.

TRACE1 to **TRACE3** selects trace 1 to 3.

LIST reads the peak list in the spurious measurement [LIST EVALUATION](#) (for details on this measurement see page 190).

The suffix at TRACe<1|2> is irrelevant.

As results a list of <result of range 1>, < result of range 2>,...< result of range n> are returned.

Every single range has following format:

<No>, <Start>, <Stop>, <rbw>, <freq>, <Levelabs>, <Levelrel>, <Delta>, <Limitcheck>, <unused1>, <unused2>

Where:

No	Range number
Start	Range start frequency
Stop	Range stop frequency
Rbw	Resolution bandwidth
Freq	Frequency of the peak in the range
Levelabs	Absolute peak power of the range in dBm
Levelrel	Reserved (0.0)
Delta	Delta of the peak power to the limit line in dB
Limitcheck	Limit check state (0 = PASSED, 1 = FAILED)
Unused1	Reserved (0.0)
Unused2	Reserved (0.0)

These values are defined via the [SENSe<1|2>:]LIST:RANGe<1...20> subsystem.

SPURious reads the peak list in the spurious measurement. As results a list of frequency, level and delta to limit line values is returned. A delta limit of +200dB indicates no limit check is active.

PHOLd reads the maximum value obtained from successive measurements.

SINGle is possible only in form of a query for single measurements in the receiver mode. The values of all activated detectors are transferred separated by commas in the following order: POS, NEG, QPE, AVER, RMS. For inactive detectors, the value and the comma are omitted at the position(s) in question.

SCAN is only possible in form of a query during scan measurements. The number of transmitted measurements results depend on the scan settings.

STATus is only possible in form of a query during the scan measurements. 1 byte status information per measurement result is transmitted:
bit 2: overrange trace1 to 3;

ABITstream reads the bit streams of all 15 slots one after another.

FINAL1 to **FINAL3** are onay possible in form of a query. The final measurement values are transmitted.

Return value: The returned values are scaled in the current level unit. Returned FM-modulated measurement values (activated option R&S FS-K7) are scaled in Hz.

Example: "TRAC TRACE1, "+A\$ (A\$: data list in the current format)
"TRAC? TRACE1"

Characteristics: *RST value: -
SCPI: conforming

Mode: all

Return value: The returned values are scaled in the current level unit. Returned FM-modulated measurement values (activated option FS-K7) are scaled in Hz.

ASCII format (FORMat ASCII):

In ASCII format, a list of values separated by commas is returned (Comma Separated Values = CSV).

The number of measurement points is 501 (default). For more information refer to [“SWEEP POINTS” on page 4.93](#)).

Binary format (FORMat REAL,32):

If the transmission takes place using the binary format (REAL,32), the data are transferred in block format (Definite Length Block Data according to IEEE 488.2). They are arranged in succeeding lists of I and Q data of 32 Bit IEEE 754 floating point numbers. General structure of return string for a sweep with 501 points:

#42004<meas value 1><meas value value2> to <meas value 501>

with

- #4: digits of the subsequent number of data bytes (4 in the example)
- 2004: Number of the subsequent data bytes (2004 in the example)
- <meas value x>: 4 byte floating point measurement values

Saving and recalling:

Saving and recalling trace data together with the device settings to/from the device-internal hard disk or to/from a memory stick/floppy is controlled via the commands `MMEMoRY:STORe:STATe` and `MMEMoRY:LOAD:STATe` respectively. Trace data are selected with `"MMEMoRY:SELeCt[:ITEM]:ALL"` or `"MMEMoRY:SELeCt[:ITEM]:TRACe"`. Trace data in ASCII format (ASCII FILE EXPORT) are exported with the command `"MMEMoRY:STORe:TRACe"`.

The commands for final measurement data are `"MMEMoRY:SELeCt[:ITEM]:FINAl"` and `"MMEMoRY:STORe:FINAl"`.

Transfer format:

The trace data are transferred in the current format (corresponding to the command `FORMAt ASCIi|REAL`). The device-internal trace memory is addressed using the trace names 'TRACE1' to 'FINAL3'.

The transfer of trace data from the control computer to the instrument takes place by indicating the trace name and then the data to be transferred. In ASCII format, these data are values separated by commas. If the transfer takes place using the format `real (REAL,32)`, the data are transferred in block format.

The parameter of the query is the trace name TRACE1 to FINAL3, it indicates which trace memory will be read out.

6.20.2 Number and Format of the Measurement Values for the Different Operating Modes

The number of measurement values depends on the instrument setting:

Analyzer mode (span > 0 and zero span):

155 up to 30001 (default 625) results are output in the unit selected for display.

For spurious emissions measurement the number of results is the sum of all sweep points, specified in the sweep list configuration.



With AUTO PEAK detector, only positive peak values can be read out.

Trace data can be written into the instrument with logarithmic display only in dBm, with linear display only in volts.

`FORMat REAL, 32` is to be used as format for binary transmission, and `FORMat ASCii` for ASCII transmission.

`SPURious` reads the peak list in the spurious measurement. As results a list of frequency, level and delta to limit line values is returned. A delta limit of +200dB indicates no limit check is active.

Receiver mode



For reasons of compatibility with the ESIB test receiver, the data structure of the status information is designed for 4 traces. However, only 3 traces can be activated and transferred.

`SINGLE` is possible only as a query for single measurements in the receiver mode (bargraph). The values of all activated detectors are transferred separated by commas in the following order: POS, NEG, QPE, AVER, CAV, RMS, CRMS. For inactive detectors, the value and the comma are omitted at the position(s) in question.

`PHOLD` returns the peakhold value or values of the bargraph measurements with the associated frequencies. (`DISP:BARG:PHOL ON`).

`SCAN` is only possible in form of a query during scan measurements. The number of transmitted measurement results depends on the scan settings.

`FORMAT REAL,32` is to be used as format setting for binary transmission.

Structure of transmitted data:

- 4 byte: trace status: bit 0 to 9 subscan; bit 10: last block of subscan; Bit 11: last block of last subscan of scan; Bit 12: last of all blocks (for multiple scans after the last scan)
- 4 bytes: number n of the transmitted measurement results of a trace
- 4 byte: trace1 active (0/1)
- 4 byte: trace2 active (0/1)
- 4 byte: trace3 active (0/1)
- n*4 bytes: measurement results of trace 1 if trace 1 is active
- n*4 bytes: measurement results of trace 2 if trace 2 is active
- n*4 bytes: measurement results of trace 3 if trace 3 is active

– n*1 byte:status information per measurement result:

bit 2: overrange trace1 to trace 3;

STATus is only possible in form of a query during scan measurements. 1 byte status information per measurement result is transmitted:

bit 2: overrange trace1 to trace 3;

FINAL1, FINAL2 and FINAL3 are only possible in form of a query. The final measurement values are transmitted.

TRACe<1|2>:COPY TRACE1| TRACE2| TRACE3 , TRACE1| TRACE2| TRACE3

This command copies data from one trace to another. The second operand describes the source, the first operand the destination of the data to be copied.

The associated measurement window is selected with the numeric suffix of TRACe<1|2>.

Example: "TRAC:COPY TRACE3,TRACE1"

Characteristics: *RST value: -
SCPI: conform

Mode: R, A

This command is an event and therefore has no query and no *RST value.

TRACe<1|2>:FEED:CONTRol<1..3> ALWayS | NEVer

This command switches block data transmission during a scan on and off. The availability of data is reported in the STATus:OPERation-Register.

The block size depends on scan time and the upper limit defined by TRACe:POINts:LIMit.

Example: "TRAC:FEED:CONT ALW"
'switches to single-sweep mode

Characteristics: *RST value: NEVer
SCPI: conform

Mode: R

TRACe<1|2>:IMMEDIATE:LEVel?

This query returns the current Y results of the sweep. During a sweep the last measured value is read out.

Example: "INIT:CONT OFF"
'switches to single-sweep mode

"INIT"
'starts a sweep (without waiting for the sweep end!)

"TRAC1:IMM:LEV?"
'queries the level of the last measured measurement point

Characteristics: *RST value:
SCPI: conform

Mode: A

TRACe<1|2>:IMMEDIATE:RESult?

This query returns the current X and Y results of the sweep. During a sweep the last measured values are read out.

Example:

```
"INIT:CONT OFF"  
'switches to single-sweep mode  
  
"INIT"  
'starts a sweep (without waiting for the sweep end!)  
  
"TRAC:IMM:RES?"  
'queries the X and Y values of the last measured measurement point
```

Characteristics: *RST value:
SCPI: conform

Mode: A

6.20.3 TRACe:IQ Subsystem

The commands of this subsystem are used for collection and output of measured IQ data. A special memory is therefore available in the instrument with 128k words for the I and Q data. The measurement is always performed in the time domain (span = 0 Hz) at the selected center frequency. The number of samples to be collected can be set. The sample rate can be set in the range from 15.625 kHz to 32 MHz; if channel filters are used, the sample rate is a function of the filter involved and can be determined by a separate command depending on the setting. Prior to being stored in memory or output via GPIB, the measurement data are corrected in terms of frequency response.

Depending on the sample rate, the following maximum bandwidths can be obtained during the measurement.

Sample rate	Max. bandwidth	Notes
32 MHz	9.6 MHz	
16 MHz	7.72 MHz	
8 MHz	4.8 MHz	Signals outside the given bandwidth are folded back into the useful band due to the anti-aliasing filter.
4 MHz	2.8 MHz	
2 MHz	1.6 MHz	max. bandwidth = 0.8 * sample rate for sample rate ≤ 2 MHz
1 MHz	800 kHz	
500 kHz	400 kHz	
250 kHz	200 kHz	
125 kHz	100 kHz	
62.5 kHz	50 kHz	
31.25 kHz	25 kHz	
15.625 kHz	12.5 kHz	

Due to the sampling concept (21.4 MHz IF, 32 MHz Sampling rate), the image frequency is suppressed only by the 10 MHz analog IF filter. When applying an input signal at the edge of the 10 MHz band (+5 MHz from center), the image frequency appears 800 kHz above the input signal.

The image frequency in MHz is calculated as follows:

$$f_{\text{image}} = 2 \times (f_{\text{center}} + 5.4 \text{ MHz}) - f_{\text{signal}}$$

where

f_{image} = image frequency in MHz

f_{center} = center frequency in MHz

f_{signal} = frequency of the signal to be measured in MHz

For correct operation the RF input signal shall be limited in bandwidth. Signals more than 5.4 MHz above the center frequency will be mirrored into the 10 MHz pass band.

For additional bandwidth limitation of the measurement data the analog filters (RBW ≥ 300 kHz) are available.

Fig. 6.2 shows the analyzer hardware from the IF section to the processor. The IF filter is the resolution filter of the R&S ESCI with bandwidths selectable from 300 kHz to 10 MHz. The A/D converter samples the IF signal (20.4 MHz) at a rate of 32 MHz.

The digital signal is down-converted to the complex baseband, lowpass-filtered, and the sampling rate is reduced, i.e. the output sampling rate is set between 15.625 kHz and 32 MHz by dividing the original sampling rate by powers of 2. This avoids unnecessary oversampling at narrower bandwidths, which saves processing time and increases the maximum recording time.

The I/Q data are written to separate memories of 128 k words each (512 k words with option R&S FSP-B70). The memories are hardware-triggered.

Fig. 6.2 Block diagram illustrating the R&S ESCI signal processing

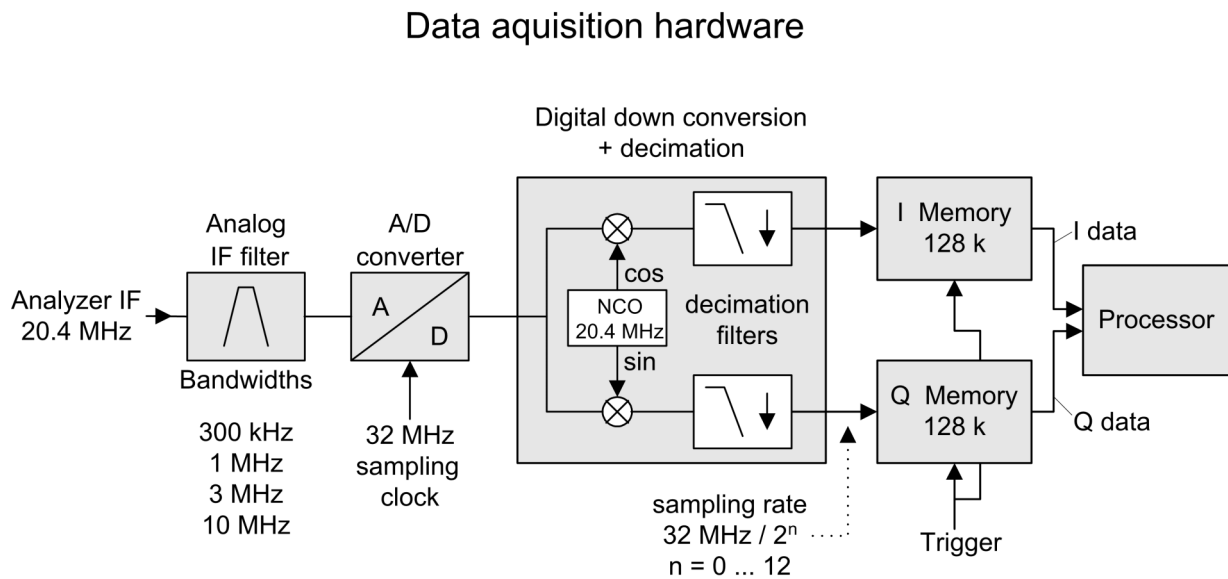

Maximum useful bandwidth		
Sample rate from	Sample rate to	Maximum bandwidth
> 81.6 MHz	<163.2 MHz	0.68 sample rate
163.2 MHz	326.4 MHz	120 MHz

TRACe<1|2>:IQ:AVERAge[:STATe] ON|OFF

The command enables averaging of the recorded I/Q data provided that I/Q data acquisition was previously enabled with TRAC:IQ ON and the sampling rate was set to 32 MHz.



Averaging is not supported at sampling rates \leq 32 MHz or for a trigger offset < 0 .

Example:

```
TRAC:IQ ON
'Switches on acquisition of I/Q data.

TRAC:IQ:SYNC ON
'Switches on synchronization of the acquisition of I/Q measurement data with the
trigger time.

TRAC:IQ:SET NORM,10MHz,32MHz,EXT,POS,0,2048
'Reads 2048 I/Q values starting at the time of trigger.
'Filter type: NORMAL (analogue)
'RBW: 10 MHz
'Sample Rate: 32 MHz
'Trigger: external
'Slope: positive

TRAC:IQ:AVER ON
'Enables averaging of the recorded I/Q data..

TRAC:IQ:AVER:COUN 10
'Selects averaging over 10 data sets..

TRAC:IQ:DATA?
'Starts the measurement and reads out the averaged data.
```

Characteristics: *RST value: OFF
SCPI: device-specific

Mode: A-T

This command is available from firmware version 1.36 or higher.

TRACe<1|2>:IQ:AVERAge:COUNT 0 .. 32767

This command defines the number of I/Q data sets that are to serve as a basis for averaging.

Example:

```
TRAC:IQ:ON
'Switches on acquisition of I/Q data.

TRAC:IQ:SYNC:ON
'Switches on synchronization of the acquisition of I/Q measurement data with the
trigger time.

TRAC:IQ:SET:NORM,10MHz,32MHz,EXT,POS,0,2048
'Reads 2048 I/Q values from the moment of triggering.
'Filter type: NORMAL (analogue)
'RBW: 10 MHz
'Sample Rate: 32 MHz
'Trigger: external
'Slope: positive

TRAC:IQ:AVER:ON
'Enables averaging of the I/Q measurement data

TRAC:IQ:AVER:COUN:10
'Selects averaging over 10 data sets

TRAC:IQ:DATA?
'Starts the measurement and reads out the averaged data.
```

Characteristics: *RST value: 0
SCPI: conform

Mode: A

This command is available from firmware version 1.36 or higher.

TRACe<1|2>:IQ:DATA?

This command starts a measurement with the settings defined via `TRACe:IQ:SET` and returns the list of measurement results immediately after they are corrected in terms of frequency response. The number of measurement results depends on the settings defined with `TRACe:IQ:SET`, the output format depends on the settings of the `FORMat` – subsystem.



The command requires that all response data are read out completely before the instrument accepts further commands.

Parameter: none

Example:

```
"TRAC:IQ:STAT ON"
'Enables acquisition of I/Q data

"TRAC:IQ:SET NORM,10MHz,32MHz,EXT,POS,0,4096"
'Measurement configuration:
'Filter type: Normal
'RBW: 10 MHz
'Sample Rate: 32 MHz
'Trigger Source: External
'Trigger Slope: Positive
'Pretrigger Samples: 0
'# of Samples: 4096

"FORMat REAL,32"
'Selects format of response data

"TRAC:IQ:DATA?"
'Starts measurement and reads results
```

Return value: The result values are scaled linear in unit *Volt* and correspond to the voltage at the RF input of the instrument.

ASCII Format (FORMat ASCII):

In this case the command returns a comma separated list of the measured voltage values in floating point format (Comma Separated Values = CSV). The number of values returned is $2 \times$ number of samples, the first half being the I-values, the second half the Q-values.



With $>512 \text{ k} \equiv 524288$ samples, the data is transmitted in logical blocks of 512k values. See below.

Binary Format (FORMat REAL,32):

In this case, the command returns binary data (Definite Length Block Data according to IEEE 488.2), with the lists of I- and Q-data being arranged one after the other in 32 Bit IEEE 754 floating point data. The scheme of the response string is as follows:

```
#41024<I-value1><I-value2>...<I-value128><Q-value1><Q-value2>...<Q-value128>
```

- #4: digits of the subsequent number of data bytes (4 in the example)
- 1024: number of subsequent data bytes (*# of DataBytes*, 1024 in the example)
- <I-value x>: 4-Byte-Floating Point I-value (max. 128k resp. 512k with option R&S FSP-B70)
- <Q-value y>: 4-Byte-Floating Point Q-value (max. 128k resp. 512k with option R&S FSP-B70)

The number of I- and Q-data can be calculated as follows:

of I-data = # of Q-data = (*# of DataBytes*) / 8

The offset of Q-data in the output buffer can be calculated as follows:

Q-data offset = (*# of DataBytes*) / 2 + *LengthIndicatorDigit*

with *LengthIndicatorDigits* being the number of digits of the length indicator including the '#'. In the example above (#41024...) this results in a value of 6 for *LengthIndicatorDigits* and the offset for the Q-data will result in $512 + 6 = 518$.

Characteristics: *RST value: --



Using the command with the *RST values for the TRAC:IQ:SET command, the following minimum buffer sizes for the response data are recommended:

ASCII format: 10 kBytes

Binary format: 2 kBytes

SCPI: device-specific

Mode: A-T

TRACe<1|2>:IQ:DATA:FORMat COMPatible | IQBLock | IQPair

Parameter: COMPatible: First, all I and then all Q data is transferred
 IQBLock: First, all I and then all Q data is transferred
 IQPair: I/Q data is transferred in pairs

Example: "TRAC:IQ:DATA:FORM IQP"

Characteristics: *RST value: COMP
 SCPI: device-specific

Mode: A

TRACe<1|2>:IQ:DATA:MEMory[:RF]? <offset samples>, <# of samples>

This command permits the readout of previously acquired (and frequency response corrected) I/Q data from the memory, with indication of the offset related to the start of measurement and with indication of the number of measurement values. Therefore a previously acquired data set can be read out in smaller portions. The maximum amount of available data depends on the settings of command TRACe:IQ:SET, the output format on the settings in the FORMat – subsystem.



The command requires that all requested measurement data be completely retrieved before the device accepts any further commands.

If no baseband IQ data is available in the memory because the associated measurement has not yet been started, the command generates a query error.

Parameter: <offset samples>: Offset of the values to be output, referenced to the start of the sampled data.
 Value range: 0 ... <# of samples> - 1, where <# of samples> is the value specified with the TRACe:IQ:SET command
 <# of samples>: Number of measurement values to be read.
 Value range: 1 ... <# of samples> - <offset samples> where <# of samples> is the value specified with the TRACe:IQ:SET command.

- Example:** "TRAC:IQ:STAT ON"
'activates the I/Q data sampling
- "TRAC:IQ:SET NORM,10MHz,32MHz,EXT,POS,100,4096"
'configures the measurement:
'Filter type: Normal
'RBW: 10 MHz
'Sample Rate: 32 MHz
'Trigger Source: External
'Trigger Slope: Positive
'Pretrigger Samples: 100
'# of Samples: 4096
- "INIT;*WAI"
'starts the measurement and waits for its end
- "FORMat REAL,32"
'specifies the format of the response data
- 'Reading the results:
- "TRAC:IQ:DATA:MEM? 0,2048"
'reads in 2048 I/Q values starting with the beginning of the sampling
- "TRAC:IQ:DATA:MEM? 2048,1024"
'reads in 2048 I/Q values starting with the beginning of the sampling
- "TRAC:IQ:DATA:MEM? 100,512"
'reads in 512 I/Q values starting with the trigger time (<Pretrigger Samples> was 100)
- Return value:** Irrespective of the output format selected, the data is scaled linearly with 'V' as the unit and corresponds to the voltage at the RF input of the device.
- The return buffer is similarly configured to the return buffer with the TRACe:IQ:DATA? command where all I data has the value 0.
- Characteristics:** *RST value: --
SCPI: device-specific
- Mode:** A-T

TRACe<1|2>:IQ:SET <filter type>,<rbw>,<sample rate>,<trigger source>,<trigger slope>,<pretrigger samples>,<# of samples>

This command defines the settings of the analyzer hardware for the measurement of I/Q data. This allows setting the bandwidth of the analog filters in front of the A/D converter as well as setting the sample rate, trigger conditions and the record length.



If this command is omitted, the current analyzer settings will be used for the corresponding parameters.

Parameter:

<filter type>: NORMAL

Selects the analog analyzer resolution filters as filter type. This is currently the only available filter type.

<rbw>: Bandwidth of the analog filters in front of the A/D converter.

<sample rate>: Sampling rate for the data acquisition.

Value range: 15.625 kHz, 31.25 kHz, 62.5 kHz, 125 kHz, 250 kHz, 500 kHz, 1 MHz, 2 MHz, 4 MHz, 8 MHz, 16 MHz, 32 MHz for <filter type> = NORMAL

<trigger mode>: Selection of the trigger source used for the measurement.

Values: IMMEDIATE | EXTERNAL | IFPOWER | RFPower



IFPower and RFPower are available as of model 03

of the detector board assembly. RFPower requires the TV and RF Trigger option R&S FSP-B6.

After selecting IFPower and RFPower, the trigger threshold can be set with command TRIG:LEV:IFP or TRIG:LEV:RFP.

<trigger slope>: Used trigger slope.

Values: POSITIVE | NEGATIVE

<pretrigger samples>: Number of measurement values to be recorded before the trigger point.

Range: -130559 (= -(128*1024-1-512)) to 130559 (= 128*1024-1-512)
(Negative values correspond to a trigger delay.)



For <trigger mode> = IMMEDIATE the value must be 0.

<# of samples>: Number of measurement values to record.

Value range: 1 to 130560 (= 128*1024 – 512)

Example: "TRAC:IQ:SET NORM,10MHz,32MHz,EXT,POS,0,2048"
 'Reads 2048 I/Q-values starting at the trigger point.
 'Filtertype: NORMAL (analog)
 'RBW: 10 MHz
 'Sample Rate: 32 MHz
 'Trigger: External
 'Slope: Positive

"TRAC:IQ:SET NORM,1MHz,4MHz,EXT,POS,1024,512"
 'Reads 512 I/Q-values from 1024 measurement points before the trigger point.
 'Filter type: NORMAL (analog)
 'RBW: 1 MHz
 'Sample Rate: 4 MHz
 'Trigger: External
 'Slope: Positive

Characteristics: *RST values: NORM,3MHz,32MHz,IMM,POS,0,128



For using these default settings with command TRAC:IQ:DATA? the following minimum buffer sizes for the response data are recommended:

ASCII format: 10 kBytes
 Binary format: 2 kBytes

SCPI: device-specific

Mode: A-T

TRACe<1|2>:IQ:SRATE 15.625 kHz to 32 MHz

This command sets the sampling rate for the I/Q data acquisition. Thus the sample rate can be modified without affecting the other settings.

Return value: 15.625 kHz, 31.25 kHz, 62.5 kHz, 125 kHz, 250 kHz, 500 kHz, 1 MHz, 2 MHz, 4 MHz, 8 MHz, 16 MHz, 32 MHz

Example: TRAC:IQ:SRAT 4MHZ

Characteristics: *RST value: 32 MHz
 SCPI: device-specific

Mode: A-T

TRACe<1|2>:IQ:STATe] ON | OFF

This command switches the I/Q data acquisition on or off.



The I/Q data acquisition is not compatible with other measurement functions. Therefore all other measurement functions will be switched off as soon as the I/Q measurement function is switched on. Additionally a trace display is not possible in this operating mode. Therefore all traces are set to "BLANK". Finally split screen operation will automatically be stopped.

Example: TRAC:IQ ON
'Switches on I/Q data acquisition

TRAC:IQ:ONL ON
'Switches the online output of the I/Q data on.

INIT:CONT ON
'Selects continuous measurement data output.

Characteristics: *RST value: OFF
SCPI: device-specific

Mode: A-T

TRACe<1|2>:IQ:SYNChronize[:STATe] ON | OFF

This command switches on or off the synchronization of the start of I/Q data acquisition to the trigger event. Prior to this command, I/Q data acquisition has to be switched. The synchronization is only active for sampling rate 32 MHz. It delays the internal trigger event up to 5us to ensure a phase relation between different I/Q data measurements. This is required for I/Q average.

For I/Q data measurements with exact trigger timing instead, turn off the synchronization. Otherwise, the R&S FSP produces a trigger jitter of up to 5 μ s.

By default, the synchronization is ON.



This command is not supported for sampling rates other than 32 MHz.

```
"TRAC:IQ ON"
'Switches on I/Q data acquisition

"TRAC:IQ:SYNC ON ON"
'Switches on synchronization of I/Q data acquisition to the trigger event

"TRAC:IQ:SET NORM,10MHz,32MHz,EXT,POS,0,2048"
'Reads 2048 I/Q-values starting at the trigger point.
'Filtertype: NORMAL (analog)
'RBW: 10 MHz
'Sample Rate: 32 MHz
'Trigger: External
'Slope: Positive

TRAC:IQ:AVER ON
'Enables averaging of the I/Q measurement data

TRAC:IQ:AVER:COUN 10
'Selects averaging over 10 data sets

TRAC:IQ:DATA?
'Starts the measurement and reads out the averaged data.
```

Characteristics: *RST value: ON
SCPI: device-specific

Mode: A-T

This command is available from firmware version 1.40 or higher.

TRACe<1|2>:POINTS LIMit, 1 to 10000

This command defines the maximum number of measurement points which are transferred in one block after the query command TRACe? SCAN. The total amount of bytes which is transferred depends on the number of active traces.

Example: "TRAC:POIN LIM, 8000"
'A maximum of 8000 measurement values per trace will be transferred with a single query

Characteristics: *RST value: 1000
SCPI: device-specific

Mode: R

6.21 TRIGger Subsystem

The TRIGger subsystem is used to synchronize instrument actions with events. It is thus possible to control and synchronize the start of a sweep. An external trigger signal can be applied to the connector at the rear panel of the instrument. A distinction is made between TRIGger1 (screen A) and TRIGger2 (screen B).

TRIGger<1|2>[:SEQuence]:SOURce IMMEDIATE | EXTERNAL | VIDEO | IFPOWER | RFPower | TV | AF | AM | FM | PM

This command selects the trigger source for the start of a sweep.



The trigger source selection has to be done with the command `TRIGger<1|2>[:SEQuence]:SYNChronize:ADJust`.

The selection RFPower or TV is only available with option R&S FSP-B6 (TV and RF Trigger).

The parameters AF, AM, FM and PM are only available if option FM Demodulator (R&S FS-K7) is enabled.

Parameter:

IMMEDIATE	Automatic triggering of the next measurement at the end of the previous one. The value IMMEDIATE corresponds to the FREE RUN setting.
EXTERNAL	The next measurement is triggered by the signal at the external trigger input.
VIDEO	The next measurement is triggered by the detection of a signal at the video filter output.
IFPOWER	The next measurement is triggered by the detection of a signal at the instrument IF (10 MHz bandwidth)
RFPower	The next measurement is triggered by the detection of a signal at the instrument RF (80 MHz bandwidth)
TV	The next measurement is triggered by the detection of a TV signal according to the settings of the <code>TRIGger:SEQuence:VIDeo</code> -subsystem (not available for FM demodulator mode)

Example: `"TRIG:SOUR EXT"`
 'Selects the external trigger input as source of the trigger signal

Characteristics: *RST value: IMMEDIATE
 SCPI: conform

Mode: R, A

TRIGger<1|2>[:SEQuence]:LEVel[:EXTERNAL] 0.5 to +3.5 V

This command sets the level of the external trigger source.

Example: `"TRIG:LEV 2V"`

Characteristics: *RST value: 1.4 V
 SCPI: device-specific

Mode: A

TRIGger<1|2>[:SEQUENCE]:LEVel:IFPower -30 to -10 dBm

This command sets the level of the IF power trigger source.

Example: "TRIG:LEV:IFP -20DBM"

Characteristics: *RST value: -20 dBm
SCPI: device-specific

Mode: R, A

TRIGger<1|2>[:SEQUENCE]:LEVel:RFPower -50 to -10 dBm

This command sets the level of the RF power trigger source.

Example: "TRIG:LEV:RFP -20DBM"

Characteristics: *RST value: -20 dBm
SCPI: device-specific

Mode: R, A

This command is only available with option R&S FSP-B6 (TV and RF Trigger).

TRIGger<1|2>[:SEQUENCE]:LEVel:VIDeo 0 to 100PCT

This command sets the level of the video trigger source.

Example: "TRIG:LEV:VID 50PCT"

Characteristics: *RST value: 50 PCT
SCPI: device-specific

Mode: R, A

TRIGger<1|2>[:SEQUENCE]:HOLDoff -100 to 100s

This command defines the length of the trigger delay.

A negative delay time (pretrigger) can be set in the time domain (span = 0 Hz) only.

Example: "TRIG:HOLD 500us"

Characteristics: *RST value: 0 s
SCPI: conform

Mode: R, A

TRIGger<1|2>[:SEQUENCE]:HOLDoff:ADJust:AUTO ON|OFF

This command defines whether the group delay of the bandwidth filters for the external trigger is compensated (ON) or not (OFF). If a burst signal is analyzed in the time domain mode, the rising edge will remain at the same time position if compensation is on and the bandwidth changes.

Example: "TRIG:HOLD:ADJ:AUTO ON"

Characteristics: *RST value: OFF
SCPI: device-specific

Mode: R, A

TRIGger<1|2>[:SEQUence]:SLOPe POSitive | NEGative

This command selects the slope of the trigger signal. The measurement starts on a positive or negative slope of the trigger signal. The selected trigger slope applies to all trigger signal sources.

Example: "TRIG:SLOP NEG"

Characteristics: *RST value: POSitive
SCPI: conform

Characteristics: SCPI: device-specific

Mode: R, A

TRIGger<1|2>[:SEQUence]:VIDeo:FORMat:LPFRame 525 | 625

This command defines the line system in use (525 or 625 lines) with active TV trigger.

Example: "TRIG:VID:FORM:LPFR 525"

Characteristics: *RST value: --
SCPI: conform

Mode: A-T

This command is only available with option R&S FSP-B6 (TV and RF Trigger).

TRIGger<1|2>[:SEQUence]:VIDeo:LINE:NUMBer <numeric_value>

With active TV trigger this command activates triggering at the horizontal sync signal of the indicated line number.

Example: "TRIG:VID:LINE:NUMB 17"

Characteristics: *RST value:
SCPI: conform

Mode: A-T

This command is only available with option R&S FSP-B6 (TV and RF Trigger).

TRIGger<1|2>[:SEQUence]:VIDeo:FIELD:SELect ALL | ODD | EVEN

With active TV trigger this command activates triggering at the vertical sync signal.

The measurement is triggered on both fields with selection ALL, on odd fields with selection ODD and on even fields with selection EVEN.

Example: "TRIG:VID:FIELD:SEL ALL"

Characteristics: *RST value:
SCPI: conform

Mode: A-T

This command is only available with option R&S FSP-B6 (TV and RF Trigger).

TRIGger<1|2>[:SEQuence]:VIDeo:SSIGnal:POLarity NEGative | POSitive

With active TV trigger this command selects the polarity of the video sync signal.

Example: "TRIG:VID:SSIG:POL NEG"

Characteristics: *RST value:
SCPI: conform

Mode: A-T

This command is only available with option R&S FSP-B6 (TV and RF Trigger).

6.22 UNIT Subsystem

The UNIT subsystem is used to switch the base unit of setting parameters.

The numeric suffix at UNIT<1|2> selects the measurement window.

UNIT<1|2>:POWer DBM | V | A | W | DB | PCT | UNITLESS | DBPW | WATT | DBUV | DBMV | VOLT |
DBUA | AMPere | DBPT | DBUV_M | DBUA_M

Example: This command selects the unit for power for the selected measurement window.
"UNIT:POW DBM"
'Sets the power unit for screen A to dBm.

Characteristics:

Characteristics: *RST value: DBUV
SCPI: conform

Mode: R, A

6.23 GPIB Commands of HP Models 856xE, 8566A/B, 8568A/B and 8594E

6.23.1 Introduction

The R&S FSP analyzer family supports a subset of the GPIB commands of HP models 8560E, 8561E, 8562E, 8563E, 8564E, 8565E, 8566A, 8566B, 8568A, 8568B and 8594E.

Despite the differences in system architecture and device features, the supported commands have been implemented in a way to ensure a sufficiently high degree of correspondence with the original.

This includes the support of syntax rules for not only newer device families (B and E models) but for the previous A family as well.

In many cases the selection of commands supported by the R&S ESCI is sufficient to run an existing GPIB program without adaptation.

The device model to be emulated is selected manually by means of the key sequence *SETUP - GENERAL SETUP - GPIB - GPIB LANGUAGE* via the GPIB using the *SYSTEM:LANGUage* command.

To make it possible to also emulate device models that are not part of the selection list of the GPIB LANGUAGE softkey, the identification string received in response to the ID command can be modified (key sequence *SETUP - GENERAL SETUP - GPIB - ID STRING USER*). This allows any device model to be emulated whose command set is compatible with one of the supported device models.

6.23.2 Command Set of Models 8560E, 8561E, 8562E, 8563E, 8564E, 8565E, 8566A/B, 8568A/B, 8591E, 8594E, 71100C, 71200C, and 71209A

As with the original units, the R&S ESCI includes the command set of the A models in the command set of the B models.



The HP model 8591E is compatible to HP model 8594E, the HP models 71100C, 71200C, and 71209A are compatible to HP models 8566A/B.

Command	Supported subset	Function	Corresponding HP-Models	Status
A1	A1	Clear/Write A	HP 8566A/ HP 8568A	available
A2	A2	Max Hold A	HP 8566A/ HP 8568A	available
A3	A3	View A	HP 8566A/ HP 8568A	available
A4	A4	Blank A	HP 8566A/ HP 8568A	available
ABORT ¹⁾	ABORT	Stop previous function	HP 856xE / HP 8566B / HP 8568B / HP 8594E	available
ADD		Add	HP 8566B / HP 8568B / HP 8594E	available in V4.1x and above

GPIB Commands of HP Models 856xE, 8566A/B, 8568A/B and 8594E

Command	Supported subset	Function	Corresponding HP-Models	Status
ADJALL	ADJALL	Adjust all	HP 856xE / HP 8566B / HP 8568B / HP 8594E	available in V3.2x and above
ADJCRT 2)	ADJCRT	Adjust CRT	HP 856xE / HP 8566B / HP 8568B / HP 8594E	available in V3.2x and above
ADJIF 2)	ADJIF	Auto adjust IF	HP 856xE / HP 8566B / HP 8568B / HP 8594E	available in V3.2x and above
AMB	AMB ON OFF AMB 1 0 AMB?	Trace A - B -> Trace A	HP 856xE / HP 8594E	available in V3.3x and above
AMBPL	AMBPL ON OFF AMBPL 1 0 AMBPL?		HP 856xE / HP 8566B / HP 8568B / HP 8594E	available
ANNOT	ANNOT ON OFF ANNOT 1 0 ANNOT?	Annotation	HP 856xE / HP 8566B / HP 8568B / HP 8594E	available
APB	APB	Trace A + B -> Trace A	HP 856xE / HP 8566B / HP 8568B / HP 8594E	available in V3.3x and above
AT	AT <numeric_value> DB DM AT DN AT UP AT AUTO AT?	Attenuation	HP 8566A/ HP 8568A/ HP 856xE / HP 8566B / HP 8568B / HP 8594E	available
AUNITS	AUNITS DBM DBMV DBUV AUNITS?	Amplitude Units	HP 856xE / HP 8566B / HP 8568B / HP 8594E	available
AUTOCP	AUTOCP	Coupling default	HP 856xE / HP 8566B / HP 8568B / HP 8594E	available in V3.2x and above
AXB	AXB	Exchange trace A and B	HP 856xE / HP 8566B / HP 8568B / HP 8594E	available in V3.2x and above
B1	B1	Clear/Write B	HP 8566A/ HP 8568A	available
B2	B2	Max Hold B	HP 8566A/ HP 8568A	available
B3	B3	View B	HP 8566A/ HP 8568A	available

GPIB Commands of HP Models 856xE, 8566A/B, 8568A/B and 8594E

Command	Supported subset	Function	Corresponding HP-Models	Status
B4	B4	Blank B	HP 8566A/ HP 8568A	available
BL	BL	Trace B - Display Line -> Trace B	HP 8566A/ HP 8568A	available in V3.3x and above
BML	BML	Trace B - Display Line -> Trace B	HP 856xE/ HP8594E	available in V3.3x and above
BTC	BTC	Transfer Trace B -> C	HP 856xE / HP 8566B / HP 8568B / HP 8594E	available in V3.3x and above
BXC	BXC	Exchange Trace B and C	HP 856xE / HP 8566B / HP 8568B / HP 8594E	available in V3.3x and above
BLANK	BLANK TRA TRB TRC	Blank Trace	HP 856xE / HP 8566B / HP 8568B / HP 8594E	available
C1	C1	A-B off	HP 8566A/ HP 8568A	available
C2	C2	A-B -> A	HP 8566A/ HP 8568A	available
CA	CA	Couple Attenuation	HP 8566A/ HP 8568A	available
CAL ¹⁾	CAL ALL CAL ON CAL OFF	Start analyzer self alignment	HP 856xE / HP 8566B / HP 8568B / HP 8594E	available
CF	CF <numeric_value> HZ KHZ MHZ GHZ CF UP CF DN CF?	Center Frequency	HP 8566A/ HP 8568A/ HP 856xE / HP 8566B / HP 8568B / HP 8594E	available
CHANPWR	CHANPWR TRA TRB, <numeric_value>,.?	Channel Power Measurement	HP 856xE / HP 8594E	available in V3.4x and above
CHPWRBW	CHPWRBW <numeric_value> HZ KHZ MHZ GHZ	Channel Power Bandwidth	HP 856xE / HP 8594E	available in V3.4x and above
CLRW	CLRW TRA TRB TRC	Clear/Write Trace	HP 856xE / HP 8566B / HP 8568B / HP 8594E	available
CLS ¹⁾	CLS	Clear all status bits	HP 856xE / HP 8566B / HP 8568B / HP 8594E	available

GPIB Commands of HP Models 856xE, 8566A/B, 8568A/B and 8594E

Command	Supported subset	Function	Corresponding HP-Models	Status
CONTS	CONTS		HP 856xE / HP 8566B / HP 8568B / HP 8594E	available
COUPLE	COUPLE AC DC	Input coupling	HP 856xE / HP 8566B / HP 8568B / HP 8594E	available in V3.2x and above
CR	CR	Couple RBW	HP 8566A/ HP 8568A	available
CS	CS	Couple Step Size	HP 8566A/ HP 8568A	available
CT	CT	Couple SWT	HP 8566A/ HP 8568A	available
CTA		Convert to absolute units	HP 8566B/ HP 8568B/ HP 8594E	available in V4.1x and above
CV	CV	Couple VBW	HP 8566A/ HP 8568A	available
D1 2)	D1	Display Size normal	HP 8566A/ HP 8568A	available in V3.3x and above
DA 2)	DA	Display address		available in V3.7x and above
DEMODO 1)	DEMODO ON OFF AM FM	AF Demodulator	HP 856xE / HP 8566B / HP 8568B / HP 8594E	available
DEMODAGC 2)	DEMODAGC ON OFF 1 0 DEMODAGC?	Demodulation AGC	HP 856xE / HP 8566B / HP 8568B / HP 8594E	available in V3.2x and above
DEMODT	DEMODT <numeric_value> S MS US SC DEMODT UP DN DEMODT?	Demodulation time	HP 856xE / HP 8566B / HP 8568B / HP 8594E	available in V3.3x and above
DET	DET POS SMP NEG DET?	Detector	HP 856xE / HP 8566B / HP 8568B / HP 8594E	available
DISPOSE2)	ONEOS TRMATH ONSWP ALL <numeric_value>			
DIV		Divide	HP 8566B / HP 8568B / HP 8594E	available in V4.1x and above
DL	DL <numeric_value> DB DM DL DN DL UP DL ON DL OFF DL?	Display Line	HP 856xE / HP 8566B / HP 8568B / HP 8594E	available

GPIB Commands of HP Models 856xE, 8566A/B, 8568A/B and 8594E

Command	Supported subset	Function	Corresponding HP-Models	Status
DLE	DLE ON OFF	Display Line enable	HP 856xE / HP 8566B / HP 8568B / HP 8594E	available in V3.3x and above
DONE	DONE DONE?	Done query	HP 856xE / HP 8566B / HP 8568B / HP 8594E	available
DW 2)	DW	Write to display and increment address		
E1	E1	Peak Search	HP 8566A/ HP 8568A	available
E2	E2	Marker to Center Freq.	HP 8566A/ HP 8568A	available
E3	E3	Deltamarker Step Size	HP 8566A/ HP 8568A	available
E4	E4	Marker to Ref. Level	available	available
EDITDONE		limit line edit done	HP 856xE	available in V4.3x and above
EDITLIML		edit limit line	HP 856xE	available in V4.3x and above
ERR	ERR 250 cal level error ERR 300 LO unlock ERR 472 cal error digital filter ERR 473 cal error analog filter ERR 552 cal error log amp ERR 902 unscale tracking generator ERR 906 oven cold ERR117 numeric unit error ERR112 Unrecognized Command	Now some FSx errors are mapped to HP errors.	HP8568A HP856xE	Available in V3.7x and above
ERR?	ERR?	Error queue query	HP 856xE / HP 8566B / HP 8568B / HP 8594E	available
EX	EX	Exchange trace A and B	HP 8566A / HP 8568A	available in V3.2x and above
FA	FA <numeric_value> HZ KHZ MHZ GHZ FA UP FA DN FA?	Start Frequency	HP 8566A/ HP 8568A/ HP 856xE / HP 8566B / HP 8568B / HP 8594E	available
FB	FB <numeric_value> HZ KHZ MHZ GHZ FB UP FB DN FB?	Stop Frequency	HP 8566A/ HP 8568A/ HP 856xE / HP 8566B / HP 8568B / HP 8594E	available

GPIB Commands of HP Models 856xE, 8566A/B, 8568A/B and 8594E

Command	Supported subset	Function	Corresponding HP-Models	Status
FOFFSET ¹⁾	FOFFSET <numeric_value> HZ KHZ MHZ GHZ FOFFSET?	Frequency Offset	HP 856xE / HP 8566B / HP 8568B / HP 8594E	available
FREF	FREF INT EXT	Reference Frequency	HP 856xE / HP 8566B / HP 8568B / HP 8594E	available in V3.2x and above
FS	FS	Full Span	HP 8566A/ HP 8568A	available
FUNCDEF		Define Function Function must be in one line between delimiters @	HP 8594E / HP 856xE / HP 8566B	available in V3.7x and above
GATE 1)	GATE ON OFF GATE 1 0		HP 856xE / HP 8566B / HP 8568B / HP 8594E	available
GATECTL 1)	GATECTL EDGE LEVEL GATECTL?		HP 856xE / HP 8566B / HP 8568B / HP 8594E	available
GD 1)	GD <numeric_value> US MS SC GD DN GD UP GD?		HP 856xE / HP 8566B / HP 8568B / HP 8594E	available
GL 1)	GL <numeric_value> US MS SC GL DN GL UP GL?		HP 856xE / HP 8566B / HP 8568B / HP 8594E	available
GP 1)	GP POS NEG GP?		HP 856xE / HP 8566B / HP 8568B / HP 8594E	available
GRAT 2)	GRAT ON OFF	Graticule	HP 856xE / HP 8566B / HP 8568B / HP 8594E	available in V3.2x and above
I1	I1		HP 8566A/ HP 8568A	available
I2	I2		HP 8566A/ HP 8568A	available
ID	ID ID?	Identify	HP 8566A/ HP 8568A/ HP 856xE / HP 8566B / HP 8568B / HP 8594E	available

GPIB Commands of HP Models 856xE, 8566A/B, 8568A/B and 8594E

Command	Supported subset	Function	Corresponding HP-Models	Status
INZ 1)	INZ 75 INZ 50 INZ?	Input Impedance	HP 856xE / HP 8566B / HP 8568B / HP 8594E	available
IP	IP	Instrument preset	HP 8566A/ HP 8568A	available
KEYDEF	KEYDEF	Key definition	HP 8566B/ HP 856xE / HP 859xE	available in V3.7x and above
KEYEXEC	KEYEXEC	Key execute	HP 8566B	available in V3.7x and above
KS=	KS= <numeric_value> HZ KHZ MHZ GHZ KS= DN KS= UP KS=?	Marker Frequency Counter Resolution	HP 8566A/ HP 8568A	available
KS/	KS/	Manual Peaking	HP 8566A/ HP 8568A	available in V3.2x and above
KS(KS(Lock register	HP 8566A/ HP 8568A	available in V3.4x and above
KS)	KS)	Unlock register	HP 8566A/ HP 8568A	available in V3.4x and above
KS91	KS91	Read Amplitude Error	HP 8566A/ HP 8568A	available in V3.4x and above
KSA	KSA	Amplitude Units in dBm	HP 8566A/ HP 8568A	available
KSB	KSB	Amplitude Units in dBmV	HP 8566A/ HP 8568A	available
KSC	KSC	Amplitude Units in dBuV	HP 8566A/ HP 8568A	available
KSD	KSD	Amplitude Units in V	HP 8566A/ HP 8568A	available
KSE	KSE <numeric_value> <char data>@	Title mode	HP 8566A/ HP 8568A	available
KSG	KSG KSG ON KSG <numeric_value>	Video Averaging on	HP 8566A/ HP 8568A	available
KSH	KSH	Video Averaging Off	HP 8566A/ HP 8568A	available
KSK		Marker to Next Peak	HP 8566A/ HP 8568A	available
KSL		Marker Noise off	HP 8566A/ HP 8568A	available
KSM		Marker Noise on	HP 8566A/ HP 8568A	available
KSO	KSO	Deltamarker to span	HP 8566A/ HP 8568A	available in V3.2x and above

GPIB Commands of HP Models 856xE, 8566A/B, 8568A/B and 8594E

Command	Supported subset	Function	Corresponding HP-Models	Status
KSP	KSP <numeric_value>	HPIB address	HP 8566A/ HP 8568A	available
KSQ ²⁾	KSQ	Band lock off	HP 8566A/ HP 8568A	available in V3.2x and above
KST	KST	Fast Preset	HP 8566A/ HP 8568A	available
KSV	KSV <numeric_value> HZ KHZ MHZ GHZ KSV?	Frequency Offset	HP 8566A/ HP 8568A	available
KSW	KSW	Error Correction Routine	HP 8566A/ HP 8568A	available
KSX	KSX	Correction Values On	HP 8566A/ HP 8568A	available
KSY	KSY	Correction Values Off	HP 8566A/ HP 8568A	available
KSZ	KSZ <numeric_value> DB KSZ?	Reference Value Offset	HP 8566A/ HP 8568A	available
KSa	KSa	Normal Detection	HP 8566A/ HP 8568A	available
KSb	KSb	Pos Peak Detection	HP 8566A/ HP 8568A	available
KSc	KSc	Neg Peak Detection	HP 8566A/ HP 8568A	available
KSe	KSe	Sample Detection	HP 8566A/ HP 8568A	available
KSg		CRT beam off		
KSh		CRT beam on		
KSj	KSj	View Trace C	HP 8566A/ HP 8568A	available
KSk	KSk	Blank Trace C	HP 8566A/ HP 8568A	available
KSl	KSl	Transfer B to C	HP 8566A/ HP 8568A	available
KSm	KSm	Graticule off	HP 8566A/ HP 8568A	available
KS _n ²⁾	KS _n	Grid on	HP 8566A/ HP 8568A	available in V3.2x and above
KSo	KS _n	Character display off	HP 8566A/ HP 8568A	available in V3.2x and above
KSp	KSp	Character display on	HP 8566A/ HP 8568A	available in V3.2x and above
KSr	KSr	Create service request	HP 8566A/ HP 8568A	available in V3.2x and above
KSt ²⁾	KSt	Band lock on	HP 8566A/ HP 8568A	available in V3.2x and above

GPIB Commands of HP Models 856xE, 8566A/B, 8568A/B and 8594E

Command	Supported subset	Function	Corresponding HP-Models	Status
KSv 2)	KSv	Signal ident on	HP 8566A/ HP 8568A	available in V3.2x and above
L0	L0	Display line off	HP 8566A/ HP 8568A	available in V3.2x and above
LB	LB <numeric_value> <char data>@	Label	HP 8566A/ HP 8568A	available in V3.2x and above
LF	LF	Low frequency band preset	HP 8566A/ HP 8568A	available in V3.2x and above
LIMD		limit line delta	HP 856xE	available in V4.3x and above
LIMF		limit line frequency	HP 856xE	available in V4.3x and above
LIMIFAIL		limit fail query	HP 856xE	available in V4.3x and above
LIMPURGE		purge limit line	HP 856xE	available in V4.3x and above
LIMIRCL		recall limit line	HP 856xE	available in V4.3x and above
LIMIREL		relative limit line	HP 856xE	available in V4.3x and above
LIMISAV		save limit line	HP 856xE	available in V4.3x and above
LIMITEST		limit line test	HP 856xE	available in V4.3x and above
LIML		lower limit line value	HP 856xE	available in V4.3x and above
LIMM		middle limit line value	HP 856xE	available in V4.3x and above
LIMTFL		flat limit line segment	HP 856xE	available in V4.3x and above
LIMTSL		slope limit line segment	HP 856xE	available in V4.3x and above
LIMU		upper limit line value	HP 856xE	available in V4.3x and above
LG	LG <numeric_value> DB DM LG?	Amplitude Scale Log	HP 856xE / HP 8566B / HP 8568B / HP 8594E	available
LL 2)	LL	Plot command	HP 8566A/ HP 8568A	available in V3.2x and above
LN	LN	Amplitude Scale Lin	HP 856xE / HP 8566B / HP 8568B / HP 8594E	available
M1	M1	Marker Off	HP 8566A/ HP 8568A	available

GPIB Commands of HP Models 856xE, 8566A/B, 8568A/B and 8594E

Command	Supported subset	Function	Corresponding HP-Models	Status
M2	M2 M2 <numeric_value> HZ KHZ MHZ GHZ M2 DN M2 UP M2?	Marker Normal	HP 8566A/ HP 8568A	available
M3	M3 M3 <numeric_value> HZ KHZ MHZ GHZ M3 DN M3 UP M3?	Delta Marker	HP 8566A/ HP 8568A	available
M4	M4 <numeric_value> HZ KHZ MHZ GHZ	Marker Zoom	HP 8566A/ HP 8568A	available
MA	MA	Marker Amplitude	HP 8566A/ HP 8568A	available
MC0	MC0	Marker Count off	HP 8566A/ HP 8568A	available
MC1	MC1	Marker Count on	HP 8566A/ HP 8568A	available
MDS	MDS	Measurement data size	HP 8566B	available in V3.7x and above
MEAS		Measurement status	HP 856xE	available in V4.3x and above
MF	MF MF?	Marker Frequency	HP 8566A/ HP 8568A/ HP 856xE / HP 8566B / HP 8568B / HP 8594E	available
MINH ¹⁾	MINH TRC	Minimum Hold	HP 856xE / HP 8566B / HP 8568B / HP 8594E	available
MKA	MKA <numeric_value> MKA?	Marker Amplitude	HP 856xE / HP 8566B / HP 8568B / HP 8594E	MKA <numeric_value> available in V3.4x and above query always available
MKACT	MKACT 1 MKACT?	Select the active marker	HP 856xE / HP 8566B / HP 8568B / HP 8594E	available
MKBW ¹⁾	MKBW <numeric_value> MKBW ON MKBW OFF	N dB Down	HP 856xE / HP 8566B / HP 8568B / HP 8594E	available

GPIB Commands of HP Models 856xE, 8566A/B, 8568A/B and 8594E

Command	Supported subset	Function	Corresponding HP-Models	Status
MKD	MKD MKD <numeric_value> HZ KHZ MHZ GHZ MKD DN MKD UP MKD ON MKD OFF MKD?	Delta Marker	HP 856xE / HP 8566B / HP 8568B / HP 8594E	available
MKDR	MKDR <numeric_value> HZ KHZ MHZ GHZ S SC MS MSEC USMKDR?	Delta Marker reverse	HP 856xE / HP 8566B / HP 8568B / HP 8594E	query available in V3.2x and above, completely available in V3.3x and above
MKDR?		Delta Marker reverse query		
MKF	MKF <numeric_value> HZ KHZ MHZ GHZ MKF?	Set Marker Frequency	HP 856xE / HP 8566B / HP 8568B / HP 8594E	available
		Marker On		hidden
MKFC	MKFC ON OFF	Frequency Counter on/off	HP 856xE / HP 8566B / HP 8568B / HP 8594E	available in V3.2x and above
MKFCR 1)	MKFCR <numeric_value> HZ KHZ MHZ GHZ MKFCR DN MKFCR UP MKFCR?	Frequency Counter Resolution	HP 856xE / HP 8566B / HP 8568B / HP 8594E	available
MKMIN	MKMIN	Marker -> Min	HP 856xE / HP 8566B / HP 8568B / HP 8594E	available
MKN	MKN MKN <numeric_value> HZ KHZ MHZ GHZ MKN DN MKN UP MKN ON MKN OFF MKN?	Normal Marker	HP 856xE / HP 8566B / HP 8568B / HP 8594E	available
MKNOISE	MKNOISE ON OFF MKNOISE 1 0 MKNOISE?	Noise Measurement	HP 856xE / HP 8566B / HP 8568B / HP 8594E	available
MKOFF	MKOFF MKOFF ALL	Marker off	HP 856xE / HP 8566B / HP 8568B / HP 8594E	available
MKP	MKP <numeric_value> MKP?	Marker position	HP 856xE / HP 8566B / HP 8568B / HP 8594E	available in V3.4x and above

GPIB Commands of HP Models 856xE, 8566A/B, 8568A/B and 8594E

Command	Supported subset	Function	Corresponding HP-Models	Status
MKPK	MKPK MKPK HI MKPK NH MKPK NR MKPK NL	Marker Search	HP 856xE / HP 8566B / HP 8568B / HP 8594E	available
MKPT	MKPT MKPT HI MKPT NH MKPT NR MKPT NL	Marker Peak Threshold	HP 856xE / HP 8566B / HP 8568B / HP 8594E	available
MKPX	MKPX <numeric_value> DB MKPX DN MKPX UP MKPX?	Peak Excursion	HP 856xE / HP 8566B / HP 8568B / HP 8594E	available
MKRL	MKRL	Ref Level = Marker Level	HP 856xE / HP 8566B / HP 8568B / HP 8594E	available
MKSP	MKSP	Deltamarker to span	HP 856xE / HP 8566B / HP 8568B / HP 8594E	available in V3.2x and above
MKSS	MKSS	CF Stepsize = Marker Freq	HP 856xE / HP 8566B / HP 8568B / HP 8594E	available
MKT	MKT <numeric_value> S MS US SC MKT?	MKF = fstart + MKT/ SWT*Span	HP 856xE / HP 8594E	available in V3.3x and above
MKTRACE	MKTRACE TRA TRB TRC	Marker to Trace	HP 856xE / HP 8566B / HP 8568B / HP 8594E	available
MKTRACK	MKTRACK ON OFF MKTRACK 1 0 MKTRACK?	Signal Track	HP 856xE / HP 8566B / HP 8568B / HP 8594E	available
MKTYPE	MKTYPE AMP MKTYPE?	Marker type	HP 856xE / HP 8566B / HP 8568B / HP 8594E	available in V3.4x and above
ML		Mixer level	HP 856xE	available in V4.3x and above
MOV	MOV TRA TRB TRC, TRA TRB TRC	Move Trace Contents	HP 856xE / HP 8566B / HP 8568B / HP 8594E	available
MPY		Multiply	HP 8566B / HP 8568B / HP 8594E	available in V4.1x and above
MT0	MT0	Marker Track Off	HP 8566A/ HP 8568A	available

GPIB Commands of HP Models 856xE, 8566A/B, 8568A/B and 8594E

Command	Supported subset	Function	Corresponding HP-Models	Status
MT1	MT1	Marker Track On	HP 8566A/ HP 8568A	available
MXMH	MXMH TRA TRB	Maximum Hold	HP 856xE / HP 8566B / HP 8568B / HP 8594E	available
NORMALIZE	NORMALIZE	Normalize trace	HP 856xE / HP 8566B / HP 8568B / HP 8594E	available in V4.1x and above available in V3.2x and above
NRL 1)	NRL <numeric_value> DB DM NRL?	Normalized Reference Level	HP 856xE / HP 8566B / HP 8568B / HP 8594E	available
NRPOS	NRPOS <numeric_value> NRL?	Normalize position	HP 856xE / HP 8566B / HP 8568B / HP 8594E	available in V3.2x and above
O1	O1	Format ASCII, Values 0 to 4095	HP 8566A/ HP 8568A	available
O2	O2	Format Binary, Values 0 to 4095	HP 8566A/ HP 8568A	available in V3.3x and above
O3	O3	Format ASCII	HP 8566A/ HP 8568A	available
OA	OA	Output All	HP 8566A/ HP 8568A	available
OL	OL <80 characters> OL?	Output Learn String	HP 8566A/ HP 8568A	available
OT	OT	Output Trace Annotations	HP 8566A/ HP 8568A	available
PA 2)	PA <numeric_value>, <numeric_value	Plot command	HP 8566A/ HP 8568A	available in V3.2x and above
PD 2)	PD <numeric_value>, <numeric_value	Plot command	HP 8566A/ HP 8568A	available in V3.2x and above
PLOTORG 2)	PLOTORG DSP GRT	Plot command	HP 856xE / HP 8566B / HP 8568B / HP 8594E	available in V3.2x and above
PLOTSRC 2)	PLOTSRC ANNT GRT TRB TRA ALLDSP GRT	Plot command	HP 856xE / HP 8566B / HP 8568B / HP 8594E	available in V3.2x and above
PP	PP	Preselector Peaking	HP 8566A/ HP 8568A	available

GPIB Commands of HP Models 856xE, 8566A/B, 8568A/B and 8594E

Command	Supported subset	Function	Corresponding HP-Models	Status
PRINT 1)	PRINT PRINT 1 0	Hardcopy	HP 856xE / HP 8566B / HP 8568B / HP 8594E	available
PSDAC 2)	PSDAC <numeric_value> PSDAC UP DN	Preselector DAC value	HP 856xE / HP 8566B / HP 8568B / HP 8594E	available in V3.2x and above
PSTATE 2)	PSTATE ON OFF 1 0	Protect State	HP 856xE / HP 8566B / HP 8568B / HP 8594E	available in V3.2x and above
PU 2)	PU	Pen Up	HP 8566A/ HP 8568A	available in V3.3x and above
PWRBW	PWRBW	Power Bandwidth	HP 8566B/ HP 859x/ HP 856xE	available in V3.7x and above
R1	R1	Set Status Bit Enable	HP 8566A/ HP 8568A	available
R2	R2	Set Status Bit Enable	HP 8566A/ HP 8568A	available
R3	R3	Set Status Bit Enable	HP 8566A/ HP 8568A	available
R4	R4	Set Status Bit Enable	HP 8566A/ HP 8568A	available
RB	RB <numeric_value> HZ KHZ MHZ GHZ RB DN RB UP RB AUTO RB?	Resolution Bandwidth	HP 856xE / HP 8566B / HP 8568B / HP 8594E	available
RBR	RBR <numeric_value> RBR DN RBR UP RBR?	Resolution Bandwidth Ratio	HP 856xE / HP 8566B / HP 8568B / HP 8594E	available in V3.2x and above
RC1...6	RC1...6	Recall Last State	HP 8566A/ HP 8568A	available
RCLS	RCLS <numeric_value>	Recall State Register	HP 856xE / HP 8566B / HP 8568B / HP 8594E	available
RCLT	RCLT TRA TRB,<number>	Recall Trace	HP856xE / HP8594E	available in V3.3x and above
RESET	RESET	Instrument preset	HP 856xE / HP 8566B / HP 8568B / HP 8594E	available
REV	REV REV?	Firmware revision	HP 856xE / HP 8566B / HP 8568B / HP 8594E	available

GPIB Commands of HP Models 856xE, 8566A/B, 8568A/B and 8594E

Command	Supported subset	Function	Corresponding HP-Models	Status
RL	RL <numeric_value> DB DM RL DN RL UP RL?	Reference Level	HP 856xE / HP 8566B / HP 8568B / HP 8594E	available
RLCAL	RLCAL <numeric_value> RL?	Reference Level Calibration	HP 856xE / HP 8566B / HP 8568B / HP 8594E	available in V3.2x and above
RCLOSCAL	RCLOSCAL	Recall Open/Short Average	HP 856xE / HP 8594E	available in V3.3x and above
RCLTHRU	RCLTHRU	Recall Thru	HP 856xE / HP 8594E	available in V3.3x and above
RLPOS 1)	RLPOS <numeric_value> RLPOS DN RLPOS UP RLPOS?	Reference Level Position	HP 856xE / HP 8566B / HP 8568B / HP 8594E	available
ROFFSET	ROFFSET <numeric_value> DB DM ROFFSET?	Reference Level Offset	HP 856xE / HP 8566B / HP 8568B / HP 8594E	available
RQS	RQS	Service Request Bit mask	HP 856xE / HP 8566B / HP 8568B / HP 8594E	available
S1	S1	Continuous Sweep	HP 8566A/ HP 8568A	available
S2	S2	Single Sweep	HP 8566A/ HP 8568A	available
SADD		add a limit line segment	HP 856xE	available in V4.3x and above
SAVES	SAVES <numeric_value>	Save State Register	HP 856xE / HP 8566B / HP 8568B / HP 8594E	available
SAVET	SAVET TRA TRB,<number>	Save Trace	HP856xE / HP8594E	available in V3.3x and above
SDEL		delete limit line segment	HP 856xE	available in V4.3x and above
SDON		limit line segment done	HP 856xE	available in V4.3x and above
SEDI		edit limit line segment	HP 856xE	available in V4.3x and above
SMOOTH	SMOOTH TRA TRB TRC, <number of points>	Smooth Trace	HP 856xE / HP 8566B / HP 8568B / HP 8594E	available in V3.4x and above
SNGLS	SNGLS	Single Sweep	HP 856xE / HP 8566B / HP 8568B / HP 8594E	available

GPIB Commands of HP Models 856xE, 8566A/B, 8568A/B and 8594E

Command	Supported subset	Function	Corresponding HP-Models	Status
SQUELCH 2)	SQUELCH <numeric_value> DM DB SQUELCH UP DN SQUELCH ON OFF	Squelch	HP 856xE / HP 8566B / HP 8568B / HP 8594E	available in V3.3x and above
SP	SP <numeric_value> HZ KHZ MHZ GHZ SP DN SP UP SP?	Span	HP 8566A/ HP 8568A/ HP 856xE / HP 8566B / HP 8568B / HP 8594E	available
SRCNORM 1)	SRCNORM ON OFF SRCNORM 1 0	Source Normalization	HP 856xE / HP 8566B / HP 8568B / HP 8594E	available
SRCPOFS 1)	SRCPOFS <numeric_value> DB DM SRCPOFS DN SRCPOFS UP SRCPOFS?	Source Power Offset	HP 856xE / HP 8566B / HP 8568B / HP 8594E	available
SRCPWR 1)	SRCPWR <numeric_value> DB DM SRCPWR DN SRCPWR UP SRCPWR ON SRCPWR OFF SRCPWR?	Source Power	HP 856xE / HP 8566B / HP 8568B / HP 8594E	available
SS	SS <numeric_value> HZ KHZ MHZ GHZ SS DN SS UP SS AUTO SS?	CF Step Size	HP 8566A/ HP 8568A/ HP 856xE / HP 8566B / HP 8568B / HP 8594E	available
ST	ST <numeric_value> US MS SC ST DN ST UP ST AUTO ST?	Sweep Time	HP 8566A/ HP 8568A/ HP 856xE / HP 8566B / HP 8568B / HP 8594E	available
STB	STB	Status byte query	HP 856xE / HP 8566B / HP 8568B / HP 8594E	available
STOREOPEN	STOREOPEN	Store Open	HP 856xE / HP 8594E	available in V3.3x and above
STORESHORT	STORESHORT	Store Short	HP 856xE / HP 8594E	available in V3.3x and above
STORETHRU	STORETHRU	Store Thru	HP 856xE / HP 8594E	available in V3.3x and above
SUB		Subtract	HP 8566B / HP 8568B / HP 8594E	available in V4.1x and above
SUM		sum of trace amplitudes	HP 8566B / HP 8568B / HP 8594E	available in V4.3x and above

GPIB Commands of HP Models 856xE, 8566A/B, 8568A/B and 8594E

Command	Supported subset	Function	Corresponding HP-Models	Status
SV1...6	SV1...6	Save State	HP 8566A/ HP 8568A	available
SWPCPL ²⁾	SWPCPL SA SR SWPCPL?	Sweep Couple	HP 856xE / HP 8566B / HP 8568B / HP 8594E	available in V3.3x and above
SWPOUT ²⁾	SWPOUT FAV FAVA RAMP SWPOUT?	Sweep Output	HP 856xE / HP 8566B / HP 8568B / HP 8594E	available in V3.2x and above
T0	T0	Threshold off	HP 8566A/ HP 8568A	available
T1	T1	Free Run Trigger	HP 8566A/ HP 8568A	available
T2 ²⁾	T2	Line Trigger	HP 8566A/ HP 8568A	available
T3	T3	External Trigger	HP 8566A/ HP 8568A	available
T4	T4	Video Trigger	HP 8566A/ HP 8568A	available
TA	TA	Transfer A	HP 8566A/ HP 8568A	available
TACL	TACL?	Returns instantaneous measurement results. See TRACe<trace #>:IMMediate: LEVel? for full description.		available in V3.7x and above
TBCL	TBCL?			
TCCL	TCCL?			
TACR	TACR?	Returns instantaneous measurement results. See TRACe<trace #>:IMMediate: LEVel? for full description.		available in V3.7x and above
TBCR	TBCR?			
TCCR	TCCR?			
TB	TB	Transfer B	HP 8566A/ HP 8568A	available
TDF	TDF P TDF M TDF B TDF A TDF I	Trace Data Format	HP 856xE / HP 8566B / HP 8568B / HP 8594E	available

GPIB Commands of HP Models 856xE, 8566A/B, 8568A/B and 8594E

Command	Supported subset	Function	Corresponding HP-Models	Status
TH	TH <numeric_value> DB DM TH DN TH UP TH ON TH OFF TH AUTO TH?	Threshold	HP 856xE / HP 8566B / HP 8568B / HP 8594E	available
THE	THE ON OFF	Threshold Line enable	HP 856xE / HP 8566B / HP 8568B / HP 8594E	available in V3.3x and above
TIMEDSP 1)	TIMEDSP ON OFF TIMEDSP 1 0 TIMEDSP?	Time Display	HP 856xE / HP 8566B / HP 8568B / HP 8594E	available
TM	TM FREE VID EXT LINE ²⁾ TM?	Trigger Mode	HP 856xE / HP 8566B / HP 8568B / HP 8594E	available
TM LINE ²⁾	TM LINE	Trigger Line	HP 8566B	available in V3.7x and above
TRA	TRA B TRA A TRA I	Transfer A	HP 856xE / HP 8566B / HP 8568B / HP 8594E	available
TRB	TRB B TRB A TRB I	Transfer B	HP 856xE / HP 8566B / HP 8568B / HP 8594E	available
TRSTAT	TRSTAT?	Trace State Query	HP 856xE / HP 8566B / HP 8568B / HP 8594E	available in V3.3x and above
TS	TS	Take Sweep	HP 856xE / HP 8566B / HP 8568B / HP 8594E	available
UR ²⁾	UR	Plot Command	HP 8566A/ HP 8568A	available in V3.2x and above
VARDEF	VARDEF	Variable definition, arrays are not supported	HP 8566B / HP 8568B / HP 8594E	available in V4.1x and above, ignored in earlier versions
VAVG	VAVG VAVG TRA TRB TRC	Video Averaging	HP 856xE / HP 8566B / HP 8568B / HP 8594E	available
VB	VB <numeric_value> HZ KHZ MHZ GHZ VB DN VB UP VB AUTO VB?	Video Bandwidth	HP 856xE / HP 8566B / HP 8568B / HP 8594E	available

GPIB Commands of HP Models 856xE, 8566A/B, 8568A/B and 8594E

Command	Supported subset	Function	Corresponding HP-Models	Status
VBR 1)	VBR <numeric_value> VBR DN VBR UP VBR?	Video Bandwidth Ratio	HP 856xE / HP 8566B / HP 8568B / HP 8594E	available
VIEW	VIEW TRA TRB TRC		HP 856xE / HP 8566B / HP 8568B / HP 8594E	available
VTL	VTL <numeric_value> DB DM VTL DN VTL UP VTL?	Video Trigger Level	HP 856xE / HP 8594E	available in V3.3x and above

1) HP 8594E only

2) Command will be accepted without error message, but will be ignored

6.23.3 Special Features of the Syntax Parsing Algorithms for 8566A and 8568A Models

The command syntax is very different for models A and B. Different names are assigned to identical instrument functions, and the command structure likewise differs considerably between models A and models B.

The command structure for models A is as follows:

<command> ::=

<command code>[<SPC>][<data>|<step>][<SPC>][<delimiter>][<command code>]...<delimiter>

<data> ::= <value>[<SPC>][<units code>][<SPC>][<delimiter>][<SPC>][<data>]...

<step> ::= UP|DN

where

<command code> = see Table "Supported Commands"

<value> = integer or floating-point numerical value

<units code> = DM | -DM | DB | HZ | KZ | MZ | GZ | MV | UV | SC | MS | US

<delimiter> = <CR> | <LF> | <,> | <;> | <ETX>

<SPC> = 32₁₀

<ETX> = 3₁₀

Command sections given in [] are optional.

The R&S ESCI GPIB hardware differs from that used in the HP analyzers. Therefore, the following constraint exists:

<LF>| <EOI> are still used as delimiters since the GPIB hardware is able to identify them. The other delimiters are identified and evaluated during syntax analysis.

6.23.4 856x: Emulation of the Spurious Response Measurement Utility 85672A

6.23.4.1 General commands for Spurious

Command	Supported subset	Function	Corresponding HP-Models	Status
SP_OK		A value of 1 denotes a successful measurement	HP 856xE	available in V4.1x and above
SP_RMT		A value of 1 means, that the instrument settings are saved to register 9	HP 856xE	available in V4.1x and above
SP_EXTREF		0: use internal reference; 1. use external reference	HP 856xE	available in V4.1x and above
SP_EXIT		Quits spurious	HP 856xE	available in V4.1x and above

6.23.4.2 Commands for TOI-Measurement

Command	Supported subset	Function	Corresponding HP-Models	Status
SP_TOI		Executes TOI measurement	HP 856xE	available in V4.1x and above
SP_TOIFA		Lower primary signal frequency in Hz	HP 856xE	available in V4.1x and above
SP_TOIFB		Upper primary signal frequency in Hz	HP 856xE	available in V4.1x and above
SP_TOIFS		Primary signal frequency spacing in Hz	HP 856xE	available in V4.1x and above
SP_TOI_SL		Lower signal amplitude in dBm	HP 856xE	available in V4.1x and above
SP_TOI_SU		Upper signal amplitude in dBm	HP 856xE	available in V4.1x and above
SP_TOI_PL		Lower distortion product amplitude in dBm	HP 856xE	available in V4.1x and above
SP_TOI_PU		Upper distortion product amplitude in dBm	HP 856xE	available in V4.1x and above
SP_TOI_A, SP_TOI_B		Third or intercept point in dBm	HP 856xE	available in V4.1x and above
SP_TOINA, SP_TOINB		The flag=0 indicates a good measurement	HP 856xE	available in V4.1x and above

6.23.4.3 Commands for Harmonic Distortion

Command	Supported subset	Function	Corresponding HP-Models	Status
SP_HARM		Executes harmonic distortion measurement	HP 856xE	available in V4.1x and above
SP_H_MAX		Maximum harmonic to be measured, range is from 2 to 10	HP 856xE	available in V4.1x and above

GPIB Commands of HP Models 856xE, 8566A/B, 8568A/B and 8594E

Command	Supported subset	Function	Corresponding HP-Models	Status
SP_H_FFLAG		Displays or hides harmonics	HP 856xE	available in V4.1x and above
SP_HPWWMIN		Minimum resolution bandwidth	HP 856xE	available in V4.1x and above
SP_H_LVL [1..10]		Array of amplitudes for each harmonic in dBc relative to the fundamental. SP_H_LVL[1] = 0 (the level of the fundamental in dBc). The index is the number of the harmonic	HP 856xE	available in V4.1x and above
SP_THD		Total harmonic distortion in percent	HP 856xE	available in V4.1x and above
SP_H_NS[1..10]		Array of flags corresponding to each measurement in the SP_H_LVL array. A value of 0 denotes a good measurement	HP 856xE	available in V4.1x and above
SP_H_FRQ		Frequency of the fundamental in Hz	HP 856xE	available in V4.1x and above
SP_H_AMP		Amplitude of the fundamental in dBm	HP 856xE	available in V4.1x and above

6.23.4.4 Commands for Spurious

Command	Supported subset	Function	Corresponding HP-Models	Status
SP_TIME		Calculates an estimated time for the spurious search	HP 856xE	available in V4.1x and above
SP_GEN		Executes the spurious search	HP 856xE	available in V4.1x and above
SP_SR_FL		Lower search limit in Hz	HP 856xE	available in V4.1x and above
SP_SR_FU		Upper search limit in Hz	HP 856xE	available in V4.1x and above
SP_DBCFLG		Values in dBm (SP_DBCFLG=0) or dBc (SP_DBCFLG=1)	HP 856xE	available in V4.1x and above
SP_SR_TH		Lower search amplitude limit in dBm or dBc	HP 856xE	available in V4.1x and above
SP_SR_TG		Upper search amplitude limit in dBm or dBc	HP 856xE	available in V4.1x and above
SP_SRTFLG		Sort flag, 0=sort output by frequencies, 1=sort output by amplitudes	HP 856xE	available in V4.1x and above
SP_SR_TM		Estimated search time in seconds	HP 856xE	available in V4.1x and above
SP_NUMSP		Number of spurious found	HP 856xE	available in V4.1x and above

GPIB Commands of HP Models 856xE, 8566A/B, 8568A/B and 8594E

Command	Supported subset	Function	Corresponding HP-Models	Status
SP_SR_F[1..50]		Array of frequencies in Hz for spurious signals found	HP 856xE	available in V4.1x and above
SP_SR_A[1..50]		Array of amplitudes of the spurious signals found in dBm or dBc	HP 856xE	available in V4.1x and above
SP_SR_CF		Reference frequency in Hz for dBc mode	HP 856xE	available in V4.1x and above
SP_SR_CP		Reference amplitude in dBm for dBc mode	HP 856xE	available in V4.1x and above

6.23.5 Special Behavior of Commands

Command	Known Differences
ABORT	Does not automatically set the command complete bit (bit 4) in the status byte. An additional DONE is required for that purpose.
ANNOT	Only frequency axis annotation is affected.
AT	AT DN/UP: Step size
CAL	The CAL commands do not automatically set the command complete bit (bit 4) in the status byte. An additional DONE command is required for that purpose.
CF	Default value, range, step size
CR	Default ratio Span / RBW
CT	Formula for coupled sweeptime
CV	Default ratio RBW / VBW
DET	DET? returns SAMP instead of SMP on the R&S ESCI. DET not automatically set the command complete bit (bit 4) in the status byte. An additional DONE is required for that purpose.
ERR?	Deletes the error bit in the status register but always returns a '0' in response.
FA	Default value, range, step size
FB	Default value, range, step size
ID	Query of instrument type. The instrument type entered with <i>SETUP - GENERAL SETUP - GPIB - ID STRING USER</i> will be returned.
M2	Default value, range, step size
M3	Default value, range, step size
MKACT	Only marker 1 is supported as the active marker.
MKBW	Default value
MKPT	Step size
MKPX	Step size
NRL	

GPIB Commands of HP Models 856xE, 8566A/B, 8568A/B and 8594E

Command	Known Differences
OL?	Storage of instrument settings: 80 characters are returned as information on the instrument settings. The contents of the 80 characters returned does not correspond to the original data contents of the 8566A / 8568A family.
OL	Readout of instrument settings: The 80 characters read by means of OL? are accepted as information on the corresponding instrument settings. The contents of the 80 characters read does not correspond to the original data contents of the 8566A / 8568A family.
RB	Default value, range, step size
RL	Default value, step size
RLPOS	Adapts the position of the reference level even if the tracking generator normalization is not active.
RQS	Supported bits: 1 (Units key pressed) 2 (End of Sweep) 3 (Device error) 4 (Command complete) 5 (Illegal command)
SRCNORM	
SRCPWR	
SP	Default value, range, step size
SS	Default value, range, step size
ST	Default value, range, step size
STB	The status bits are mapped as described with command RQS.



Bit 2 and 4 are always set in parallel if "Command Complete" or "End of Sweep" are recognized. The R&S ESCI cannot distinguish between these conditions. Additionally these bits are not suitable for synchronization on the end of sweep in continuous sweep operation.

TA	Output of 1001 trace points of trace A in O1 or O3 format.
TB	Output of 1001 trace points of trace B in O1 or O3 format.
TH	Default value
VB	Range
VBR	Default value

6.23.6 Model-Dependent Default Settings

If the GPIB language is switched over to an 85xx model, the GPIB address will automatically be switched over to 18 provided that the default address of the R&S ESCI (20) is still set. If a different value is set, this value will be maintained. Upon return to SCPI, this address will remain unchanged.

The following table shows the default settings obtained after a change of the GPIB language and for the commands IP, KST and RESET:

Model	# of Trace Points	Start Freq.	Stop Freq.	Ref Level	Input Coupling
8566A/B	1001	2 GHz	22 GHz	0 dBm	DC
8568A/B	1001	0 Hz	1.5 GHz	0 dBm	AC
8560E	601	0 Hz	2.9 GHz	0 dBm	AC
8561E	601	0 Hz	6.5 GHz	0 dBm	AC
8562E	601	0 Hz	13.2 GHz	0 dBm	AC
8563E	601	0 Hz	26.5 GHz	0 dBm	AC
8564E	601	0 Hz	40 GHz	0 dBm	AC
8565E	601	0 Hz	50 GHz	0 dBm	AC
8594E	401	0 Hz	3 GHz	0 dBm	AC



Notes regarding the set stop frequency:

- The stop frequency given in the table may be limited to the corresponding frequency range of the R&S FSUP.
- Command LF sets the stop frequency for 8566A/B to a maximum value of 2 GHz.



Note regarding the number of test points (trace points):

- The number of trace points is switched over only upon transition to the REMOTE state.

6.23.7 Data Output Formats

In the case of the SCPI and IEEE488.2 standards, the output formats for numerical data are flexible to a large extent. The output format for the HP units, by contrast, is accurately defined with respect to the number of digits. The memory areas for reading instrument data have therefore been adapted accordingly in the remote-control programs for instruments of this series.

Therefore, in response to a query, the R&S ESCI returns data of the same structure as that used by the original instruments; this applies in particular to the number of characters returned.

Two formats are currently supported when trace data is output: Display Units (command O1) and physical values (command O2, O3 or TDF P). As to the "Display Units" format, the level data of the R&S ESCI is converted to match the value range and the resolution of the 8566/8568 series. Upon transition to the REMOTE state, the R&S ESCI is reconfigured such that the number of test points (trace points) corresponds to that of the 85xx families (1001 for 8566A/B and 8568A/B, 601 for 8560E to 8565E, 401 for 8594E).

6.23.8 Trace Data Output Formats

All formats are supported for trace data output: display units (command O1), display units in two byte binary data (command O2 or TDF B and MDS W), display units in one byte binary data (command O4 or TDF B and MDS B) and physical values (commands O3 or TDF P). With format "display units" the level data will be converted into value range and resolution of the 8566/8568 models. On transition to REMOTE state the number of trace points will be reconfigured in order to be conform to the selected instrument model (1001 for 8566A/B and 8568 A/B, 601 for 8560E to 8565E, 401 for 8594E).

6.23.9 Trace Data Input Formats

Trace data input is only supported for binary date (TDF B, TDF A, TDF I, MDS W, MDS B).

6.23.10 GPIB Status Reporting

The assignment of status bits by commands R1, R2, R3, R4, RQS is supported starting at firmware version 1.8x.

The STB command and the serial poll respond with an 8-bit value having the following assignment:

Bit enabled by RQS	
0	not used (value 0)
1	Units key pressed
2	End of Sweep
3	Device Error
4	Command Complete
5	Illegal Command
6	Service Request
7	not used (value 0)

Bits 0 and 7 are not used and always have the value 0.

Please note that the R&S ESCI reports any key pressed on the front panel rather than only the unit keys if bit 1 was enabled.

Another difference is the behavior of bit 6 when using the STB? query. On the HP analyzers this bit monitors the state of the SRQ line on the bus. On the R&S ESCI this is not possible. Therefore this bit is set, as soon as one of the bits 1 to 5 is set. It won't be reset by performing a serial poll.

6.24 Differences in GPIB Behavior between the FSP and the FSE Families of Instruments

The following list of commands contains the differences in syntax and behavior between the GPIB command set of the FSP and the FSE families of instruments. Firmware options are not described in this operating manual as the related commands are not available in the basic instrument. FSE alone in column "Devices" denotes the instrument families FSE, FSIQ, FSET and ESIB, unless otherwise noted in column "Notes".

Devices		Command (<i>Sheet 1 of 47</i>)	Parameter	Notes
R&S ESCI	FSE	*CAL?		R&S ESCI: executes total calibration FSE: executes short calibration
R&S ESCI	FSE	*CLS		
R&S ESCI	FSE	*ESE		
R&S ESCI	FSE	*ESR?		
R&S ESCI	FSE	*IDN?		model indicator and version index is different for R&S ESCI and FSE
R&S ESCI	FSE	*IST?		
R&S ESCI	FSE	*OPC?		
R&S ESCI	FSE	*OPT?		list of available options is slightly different for R&S ESCI and FSE, but equally available options have equal names
R&S ESCI	FSE	*PCB		
R&S ESCI	FSE	*PRE		
R&S ESCI	FSE	*PSC		
R&S ESCI	FSE	*RST		instrument settings are slightly different for R&S ESCI and FSE due to different instrument specs
R&S ESCI	FSE	*SRE		
R&S ESCI	FSE	*STB?		

Differences in GPIB Behavior between the FSP and the FSE Families of Instruments

Devices		Command (<i>Sheet 2 of 47</i>)	Parameter	Notes
R&S ESCI	FSE	*TRG		R&S ESCI starts measurement in active screen FSE: starts measurement in both screens (split screen mode)
R&S ESCI	FSE	*TST?		
R&S ESCI	FSE	*WAI		
R&S ESCI	FSE	ABORT		
R&S ESCI		CALCulate:STATistics:APD[:STATe]	ON OFF	new function for R&S ESCI
R&S ESCI		CALCulate:STATistics:CCDF[:STATe]	ON OFF	new function for R&S ESCI
R&S ESCI		CALCulate:STATistics:NSAMples	100 to 1E9	new function for R&S ESCI
R&S ESCI		CALCulate:STATistics:PRESet		new function for R&S ESCI
R&S ESCI		CALCulate:STATistics:Result<1...3>?	MEAN PEAK CFACtor ALL	new function for R&S ESCI
R&S ESCI		CALCulate:STATistics:SCALE:AUTO	ONCE	new function for R&S ESCI
R&S ESCI		CALCulate:STATistics:X:RANGE	-10dB to 200dB	new function for R&S ESCI
R&S ESCI		CALCulate:STATistics:X:RLEVEL	-130dBm to 30dBm	new function for R&S ESCI
R&S ESCI		CALCulate:STATistics:Y:LOWer	-1E-9 to 0.1	new function for R&S ESCI
R&S ESCI		CALCulate:STATistics:Y:UPPer	-1E-8 to 1.0	new function for R&S ESCI
	FSE	CALCulate<1 2>:CTHReshold	MIN to MAX	not available in R&S ESCI
	FSE	CALCulate<1 2>:CTHReshold:STATe	ON OFF	not available in R&S ESCI
R&S ESCI		CALCulate<1 2>:DELTaMarker<1...4>:AOFF		markers 2...4 are either normal or delta markers; marker 1 always serves as the reference marker for all deltamarkers
	FSE	CALCulate<1 2>:DELTaMarker<1...4>:AOFF		there are 4 markers and 4 deltamarkers; the most recently used marker serves as the reference marker for all deltamarkers

Differences in GPIB Behavior between the FSP and the FSE Families of Instruments

Devices		Command (<i>Sheet 3 of 47</i>)	Parameter	Notes
R&S ESCI	FSE	CALCulate<1 2>:DELTamarker<1...4>:FUNctio: FIXed:RPOint:X	<numeric_value>	R&S ESCI: marker 1 can be moved independently from the reference point FSE: the marker and the reference point are linked to each other
R&S ESCI	FSE	CALCulate<1 2>:DELTamarker<1...4>:FUNctio: FIXed:RPOint:Y	<numeric_value>	R&S ESCI: marker 1 can be moved independently from the reference point; FSE: the marker and the reference point are linked to each other
R&S ESCI	FSE	CALCulate<1 2>:DELTamarker<1...4>:FUNctio: FIXed:RPOint:Y: OFFSet	<numeric_value>	
R&S ESCI		CALCulate<1 2>:DELTamarker<1...4>:FUNctio: FIXed:RPOint:MAX: PEAK		new function for R&S ESCI
R&S ESCI	FSE	CALCulate<1 2>:DELTamarker<1...4>:FUNctio: FIXed[:STATe]	ON OFF	
R&S ESCI	FSE	CALCulate<1 2>:DELTamarker<1...4>:FUNctio: PNOise:RESult?		
R&S ESCI	FSE	CALCulate<1 2>:DELTamarker<1...4>:FUNctio: PNOise[:STATe]	ON OFF	
	FSE	CALCulate<1 2>:DELTamarker<1...4>:MAXimum: APEak		not available for R&S ESCI
R&S ESCI	FSE	CALCulate<1 2>:DELTamarker<1...4>:MAXimum: LEFT		
R&S ESCI	FSE	CALCulate<1 2>:DELTamarker<1...4>:MAXimum: NEXT		
R&S ESCI	FSE	CALCulate<1 2>:DELTamarker<1...4>:MAXimum: RIGHT		
R&S ESCI	FSE	CALCulate<1 2>:DELTamarker<1...4>:MAXimum[: PEAK]		
R&S ESCI	FSE	CALCulate<1 2>:DELTamarker<1...4>:MINimum: LEFT		
R&S ESCI	FSE	CALCulate<1 2>:DELTamarker<1...4>:MINimum: NEXT		
R&S ESCI	FSE	CALCulate<1 2>:DELTamarker<1...4>:MINimum: RIGHT		
R&S ESCI	FSE	CALCulate<1 2>:DELTamarker<1...4>:MINimum[: PEAK]		
R&S ESCI	FSE	CALCulate<1 2>:DELTamarker<1...4>:MODE	ABSolute RELative	
	FSE	CALCulate<1 2>:DELTamarker<1...4>:STEP: AUTO	ON OFF	not available for R&S ESCI
	FSE	CALCulate<1 2>:DELTamarker<1...4>:STEP[: INCRement]	<numeric_value>	not available for R&S ESCI

Differences in GPIB Behavior between the FSP and the FSE Families of Instruments

Devices		Command (<i>Sheet 4 of 47</i>)	Parameter	Notes
R&S ESCI	FSE	CALCulate<1 2>:DELTamarker<1...4>:TRACe	1 to 3	R&S ESCI: 3 traces are available per screen; FSE: 4 traces are available in full screen mode and 2 traces per screen in split screen mode
R&S ESCI	FSE	CALCulate<1 2>:DELTamarker<1...4>:X	0 to MAX (frequency sweep time)	unit 'SYM' is not available for R&S ESCI
R&S ESCI	FSE	CALCulate<1 2>:DELTamarker<1...4>:X:RELative		
R&S ESCI	FSE	CALCulate<1 2>:DELTamarker<1...4>:Y?		
R&S ESCI	FSE	CALCulate<1 2>:DELTamarker<1...4>[:STATe]	ON OFF	
R&S ESCI	FSE	CALCulate<1 2>:DLINe<1 2>	MIN to MAX	
R&S ESCI	FSE	CALCulate<1 2>:DLINe<1 2>:STATe	ON OFF	
	FSE	CALCulate<1 2>:FEED	'XTIM:DDEM:MEAS' 'XTIM:DDEM:REF' 'XTIM:DDEM:ERR:MPH' 'XTIM:DDEM:ERR:VECT' 'XTIM:DDEM:SYMB' 'XTIM:AM' 'XTIM:FM' 'XTIM:PM' 'XTIM:AMSummary' 'XTIM:FMSummary' 'XTIM:PMSummary' 'TCAP'	not available for R&S ESCI
	FSET	CALCulate<1 2>:FEED	'XTIM:DDEM:MEAS' 'XTIM:DDEM:REF' 'XTIM:DDEM:ERR:MPH' 'XTIM:DDEM:ERR:VECT' 'XTIM:DDEM:SYMB' 'TCAP'	not available for R&S ESCI
R&S ESCI	FSE	CALCulate<1 2>:FLINe<1 2>	0 to f_{max}	
R&S ESCI	FSE	CALCulate<1 2>:FLINe<1 2>:STATe	ON OFF	
	FSE	CALCulate<1 2>:FORMat	MAGNitude PHASe UPHase RIMag FREQuency IEYE QEYE TEYE FEYE COMP CONS	not available for R&S ESCI
	FSE	CALCulate<1 2>:FSK:DEViation:REFerence	<numeric value>	not available for R&S ESCI
	FSE	CALCulate<1 2>:LIMit<1...8>:ACPoweR:ACHannel	0 to 100 DB, 0 to 100 DB	compatible to CALCulate<1 2>:LIMit<1...8>:ACPoweR:ACHannel[:RELative] of R&S ESCI not available for FSET

Differences in GPIB Behavior between the FSP and the FSE Families of Instruments

Devices		Command (<i>Sheet 5 of 47</i>)	Parameter	Notes
R&S ESCI		CALCulate<1 2>:LIMit<1...8>:ACPowEr: ACHannel:ABSolute	-200 to 200 DBM, -200 to 200 DBM	new function for R&S ESCI
R&S ESCI		CALCulate<1 2>:LIMit<1...8>:ACPowEr: ACHannel:ABSolute:STATe	ON OFF	new function for R&S ESCI
R&S ESCI	FSE	CALCulate<1 2>:LIMit<1...8>:ACPowEr: ACHannel:RESult?		
	FSE	CALCulate<1 2>:LIMit<1...8>:ACPowEr: ACHannel:STATe	ON OFF	compatible to CALCulate<1 2>: LIMit<1...8>:ACPowEr: ACHannel[:RELative]: STATe of R&S ESCI not available for FSET
R&S ESCI		CALCulate<1 2>:LIMit<1...8>:ACPowEr: ACHannel[:RELative]	0 to 100 DB, 0 to 100 DB	compatible to CALCulate<1 2>: LIMit<1...8>:ACPowEr: ACHannel of FSE
R&S ESCI		CALCulate<1 2>:LIMit<1...8>:ACPowEr: ACHannel[:RELative]:STATe	ON OFF	compatible to CALCulate<1 2>: LIMit<1...8>:ACPowEr: ACHannel:STATe of FSE
	FSE	CALCulate<1 2>:LIMit<1...8>:ACPowEr: ALternate<1 2>	0 to 100 DB, 0 to 100 DB	compatible to CALCulate<1 2>: LIMit<1...8>:ACPowEr: ALternate<1 2> [:RELative] of R&S ESCI not available for FSET
R&S ESCI		CALCulate<1 2>:LIMit<1...8>:ACPowEr: ALternate<1 2>:ABSolute	-200 to 200 DBM, -200 to 200 DBM	new function for R&S ESCI
R&S ESCI		CALCulate<1 2>:LIMit<1...8>:ACPowEr: ALternate<1 2>:ABSolute:STATe	ON OFF	new function for R&S ESCI
R&S ESCI	FSE	CALCulate<1 2>:LIMit<1...8>:ACPowEr: ALternate<1 2>:RESult?		
	FSE	CALCulate<1 2>:LIMit<1...8>:ACPowEr: ALternate<1 2>:STATe	ON OFF	compatible to CALCulate<1 2>: LIMit<1...8>:ACPowEr: ALternate<1 2> [:RELative]:STATe of R&S ESCI not available for FSET
R&S ESCI		CALCulate<1 2>:LIMit<1...8>:ACPowEr: ALternate<1 2>[:RELative]	0 to 100 DB, 0 to 100 DB	compatible to CALCulate<1 2>: LIMit<1...8>:ACPowEr: ALternate<1 2> of FSE
R&S ESCI		CALCulate<1 2>:LIMit<1...8>:ACPowEr: ALternate<1 2>[:RELative]:STATe	ON OFF	compatible to CALCulate<1 2>: LIMit<1...8>:ACPowEr: ALternate<1 2>: STATe of FSE
R&S ESCI	FSE	CALCulate<1 2>:LIMit<1...8>:ACPowEr[:STATe]	ON OFF	

Differences in GPIB Behavior between the FSP and the FSE Families of Instruments

Devices		Command (<i>Sheet 6 of 47</i>)	Parameter	Notes
	FSE	CALCulate<1 2>:LIMit<1...8>:BURSt:POWer?		not available for R&S ESCI, FSET and ESIB
	FSE	CALCulate<1 2>:LIMit<1...8>:BURSt:PTEMplate?		not available for R&S ESCI, FSET and ESIB
	FSE	CALCulate:LIMit:CATalog?		not available in R&S ESCI
R&S ESCI	FSE	CALCulate<1 2>:LIMit<1...8>:CLEar[:IMMediate]		
R&S ESCI	FSE	CALCulate<1 2>:LIMit<1...8>:COMMent	<string>	
R&S ESCI	FSE	CALCulate<1 2>:LIMit<1...8>:CONTRol:DOMain	FREQuency TIME	
R&S ESCI	FSE	CALCulate<1 2>:LIMit<1...8>:CONTRol:MODE	RELative ABSolute	
R&S ESCI	FSE	CALCulate<1 2>:LIMit<1...8>:CONTRol:OFFset	<numeric value>	
R&S ESCI	FSE	CALCulate<1 2>:LIMit<1...8>:CONTRol:SHIFt	<numeric_value>	
R&S ESCI	FSE	CALCulate<1 2>:LIMit<1...8>:CONTRol:SPACing	LINear LOGarithmic	
	FSE	CALCulate<1 2>:LIMit<1...8>:CONTRol:UNIT[:TIME]	S SYM	not available for R&S ESCI
R&S ESCI	FSE	CALCulate<1 2>:LIMit<1...8>:CONTRol[:DATA]	<numeric value>, <numeric value>	
R&S ESCI	FSE	CALCulate<1 2>:LIMit<1...8>:COPY	1 to 8 <name>	
R&S ESCI	FSE	CALCulate<1 2>:LIMit<1...8>:DELeTe		
R&S ESCI	FSE	CALCulate<1 2>:LIMit<1...8>:FAIL?		
R&S ESCI	FSE	CALCulate<1 2>:LIMit<1...8>:LOWer:MARGin	<numeric value>	
R&S ESCI	FSE	CALCulate<1 2>:LIMit<1...8>:LOWer:MODE	RELative ABSolute	
R&S ESCI	FSE	CALCulate<1 2>:LIMit<1...8>:LOWer:OFFset	<numeric value>	
R&S ESCI	FSE	CALCulate<1 2>:LIMit<1...8>:LOWer:SHIFt	<numeric_value>	
R&S ESCI	FSE	CALCulate<1 2>:LIMit<1...8>:LOWer:SPACing	LINear LOGarithmic	
R&S ESCI	FSE	CALCulate<1 2>:LIMit<1...8>:LOWer:STATe	ON OFF	
		CALCulate<1 2>:LIMit<1...8>:LOWer:THReshold	<numeric value>	new function for R&S ESCI

Differences in GPIB Behavior between the FSP and the FSE Families of Instruments

Devices		Command (<i>Sheet 7 of 47</i>)	Parameter	Notes
R&S ESCI	FSE	CALCulate<1 2>:LIMit<1...8>:LOWer[:DATA]	<numeric value>	
	FSE	CALCulate<1 2>:LIMit<1...8>:MARGin	0 to 100DB	not available for R&S ESCI, FSET and ESIB
R&S ESCI	FSE	CALCulate<1 2>:LIMit<1...8>:NAME	1 to 8 <string>	
	FSE	CALCulate<1 2>:LIMit<1...8>:SPECTrum: MODulation:EXCeptions?	ARFCn TXBand RXBand COMBined DCSRx1800	not available for R&S ESCI, FSET and ESIB
	FSE	CALCulate<1 2>:LIMit<1...8>:SPECTrum: MODulation:FAILs?	ARFCn TXBand RXBand COMBined DCSRx1800	not available for R&S ESCI, FSET and ESIB
	FSE	CALCulate<1 2>:LIMit<1...8>:SPECTrum: MODulation?	ARFCn TXBand RXBand COMBined DCSRx1800	not available for R&S ESCI, FSET and ESIB
	FSE	CALCulate<1 2>:LIMit<1...8>:SPECTrum: SWITChing:FAILs?		not available for R&S ESCI, FSET and ESIB
	FSE	CALCulate<1 2>:LIMit<1...8>:SPECTrum: SWITChing?		not available for R&S ESCI, FSET and ESIB
	FSE	CALCulate<1 2>:LIMit<1...8>:SPURious:FAILs?	TXBand OTXBand RXBand IDLeband	not available for R&S ESCI, FSET and ESIB
	FSE	CALCulate<1 2>:LIMit<1...8>:SPURious?	TXBand OTXBand RXBand IDLeband	not available for R&S ESCI, FSET and ESIB
R&S ESCI	FSE	CALCulate<1 2>:LIMit<1...8>:STATe	ON OFF	
R&S ESCI	FSE	CALCulate<1 2>:LIMit<1...8>:TRACe	1 to 3	R&S ESCI: 3 traces are available per screen FSE: 4 traces are available in full screen mode and 2 traces per screen in split screen mode
R&S ESCI		CALCulate<1 2>:LIMit<1...8>:UNIT	DBM DBPW WATT DBUV DBMV VOLT DBUA AMPere DB DBUV_M DBUA_M DEG RAD S HZ PCT UNITLESS	Available units are compatible to the FSE
	FSE/ FSIQ	CALCulate<1 2>:LIMit<1...8>:UNIT	DBM DBPW WATT DBUV DBMV VOLT DBUA AMPere DB DBUV_MHZ DBMV_MHZ DBUA_MHZ DBUV_M DBUA_M DBUV_MHZ DBUA_MHZ DEG RAD S HZ PCT UNITLESS	only the following units are available for the R&S ESCI:DBM DBPW WATT DBUV DBMV VOLT DBUA AMPere DB DBUV_M DBUA_M DEG RAD S HZ PCT UNITLESS

Differences in GPIB Behavior between the FSP and the FSE Families of Instruments

Devices		Command (Sheet 8 of 47)	Parameter	Notes
	FSET/ ESIB	CALCulate<1 2>:LIMit<1...8>:UNIT	DBM DBPW WATT DBUV DBMV VOLT DBUA AMPere DB DBUV_MHZ DBMV_MHZ DBUA_MHZ DBUV_M DBUA_M DBUV_MHZ DBUA_MHZ DEG RAD S HZ PCT UNITLESS	only the following units are available for the R&S ESCI: DBM DBPW WATT DBUV DBMV VOLT DBUA AMPere DB DBUV_M DBUA_M DEG RAD S HZ PCT UNITLESS
R&S ESCI	FSE	CALCulate<1 2>:LIMit<1...8>:UPPer:MARGin	<numeric value>	
R&S ESCI	FSE	CALCulate<1 2>:LIMit<1...8>:UPPer:MODE	RELative ABSolute	
R&S ESCI	FSE	CALCulate<1 2>:LIMit<1...8>:UPPer:OFFset	<numeric value>	
R&S ESCI	FSE	CALCulate<1 2>:LIMit<1...8>:UPPer:SHIFt	<numeric_value>	
R&S ESCI	FSE	CALCulate<1 2>:LIMit<1...8>:UPPer:SPACing	LINear LOGarithmic	
R&S ESCI	FSE	CALCulate<1 2>:LIMit<1...8>:UPPer:STATe	ON OFF	
R&S ESCI		CALCulate<1 2>:LIMit<1...8>:UPPer:THReshold	<numeric value>	new function for R&S ESCI
R&S ESCI	FSE	CALCulate<1 2>:LIMit<1...8>:UPPer[:DATA]	<numeric value>	
R&S ESCI	FSE	CALCulate<1 2>:MARKer<1...4>:AOFF		
R&S ESCI	FSE	CALCulate<1 2>:MARKer<1...4>:COUNT	ON OFF	
R&S ESCI	FSE	CALCulate<1 2>:MARKer<1...4>:COUNT: FREQUency?		
R&S ESCI	FSE	CALCulate<1 2>:MARKer<1...4>:COUNT: RESolution	0.1 1 10 100 1000 10000 Hz	
	FSE	CALCulate<1 2>:MARKer<1...4>: COUPLed[STATe]	ON OFF	not available for R&S ESCI
	FSE	CALCulate<1 2>:MARKer<1...4>:FUNCTION: ADEMod:AFRequency[:RESult]?		not available for R&S ESCI and FSET
	FSE	CALCulate<1 2>:MARKer<1...4>:FUNCTION: ADEMod:AM[:RESult]?	PPEak MPEak MIDDLE RMS	not available for R&S ESCI and FSET
	FSE	CALCulate<1 2>:MARKer<1...4>:FUNCTION: ADEMod:CARRier[:RESult]?		not available for R&S ESCI and FSET
	FSE	CALCulate<1 2>:MARKer<1...4>:FUNCTION: ADEMod:FERRor[:RESult]?		not available for R&S ESCI and FSET
	FSE	CALCulate<1 2>:MARKer<1...4>:FUNCTION: ADEMod:FM[:RESult]?	PPEak MPEak MIDDLE RMS RDEV	not available for R&S ESCI and FSET
	FSE	CALCulate<1 2>:MARKer<1...4>:FUNCTION: ADEMod:PM[:RESult]?	PPEak MPEak MIDDLE RMS	not available for R&S ESCI and FSET

Differences in GPIB Behavior between the FSP and the FSE Families of Instruments

Devices		Command (<i>Sheet 9 of 47</i>)	Parameter	Notes
	FSE	CALCulate<1 2>:MARKer<1...4>:FUNctioN: ADEMod:SINad:RESult?		not available for R&S ESCI and FSET
	FSE	CALCulate<1 2>:MARKer<1...4>:FUNctioN: ADEMod:SINad[:STATe]	ON OFF	not available for R&S ESCI and FSET
R&S ESCI	FSE	CALCulate<1 2>:MARKer<1...4>:FUNctioN: CENTer		
R&S ESCI	FSE	CALCulate<1 2>:MARKer<1...4>:FUNctioN: CSTep		
	FSE	CALCulate<1 2>:MARKer<1...4>:FUNctioN: DDEMod:RESult?	MERM MEPK MEPS PERM PEPK PEPS EVRM EVPK EVPS IQOF IQIM ADR FERR FEPK RHO DEV FSRM R&S ESCIK R&S ESCIS DTTS	not available for R&S ESCI
R&S ESCI		CALCulate<1 2>:MARKer<1...4>:FUNctioN: DEModulation: CONTinuous		new function for R&S ESCI
R&S ESCI	FSE	CALCulate<1 2>:MARKer<1...4>:FUNctioN: DEModulation:HOLDoff	10ms to 1000s	
R&S ESCI	FSE	CALCulate<1 2>:MARKer<1...4>:FUNctioN: DEModulation:SElect	AM FM	
R&S ESCI	FSE	CALCulate<1 2>:MARKer<1...4>:FUNctioN: DEModulation[:STATe]	ON OFF	
R&S ESCI		CALCulate<1 2>:MARKer<1...4>:FUNctioN: FPEaks[:IMMediate]	<numeric value>	new function for R&S ESCI
R&S ESCI		CALCulate<1 2>:MARKer<1...4>:FUNctioN: FPEaks:COUNT?		new function for R&S ESCI
R&S ESCI		CALCulate<1 2>:MARKer<1...4>:FUNctioN: FPEaks:X?		new function for R&S ESCI
R&S ESCI		CALCulate<1 2>:MARKer<1...4>:FUNctioN: FPEaks:Y?		new function for R&S ESCI
R&S ESCI		CALCulate<1 2>:MARKer<1...4>:FUNctioN: FPEaks:SORT	X Y	new function for R&S ESCI
R&S ESCI		CALCulate<1 2>:MARKer<1...4>:FUNctioN: MDEPth:RESult?		new function for R&S ESCI
R&S ESCI		CALCulate<1 2>:MARKer<1...4>:FUNctioN: MDEPth[:STATe]		new function for R&S ESCI
R&S ESCI		CALCulate<1 2>:MARKer<1...4>:FUNctioN: MSUMmary?	<numeric_value>, <numeric_value>, <numeric_value>, <numeric_value>	new function for R&S ESCI
	FSE	CALCulate<1 2>:MARKer<1...4>:FUNctioN: MSTep		not available for R&S ESCI
R&S ESCI	FSE	CALCulate<1 2>:MARKer<1...4>:FUNctioN: NDBDown	<numeric_value>	
R&S ESCI	FSE	CALCulate<1 2>:MARKer<1...4>:FUNctioN: NDBDown:FREQuency?		

Differences in GPIB Behavior between the FSP and the FSE Families of Instruments

Devices		Command (Sheet 10 of 47)	Parameter	Notes
R&S ESCI	FSE	CALCulate<1 2>:MARKer<1...4>:FUNction:NDBDown:RESult?		
R&S ESCI	FSE	CALCulate<1 2>:MARKer<1...4>:FUNction:NDBDown:STATe	ON OFF	
R&S ESCI	FSE	CALCulate<1 2>:MARKer<1...4>:FUNction:NOISe:RESult?		
R&S ESCI	FSE	CALCulate<1 2>:MARKer<1...4>:FUNction:NOISe:STATe	ON OFF	
	FSE	CALCulate<1 2>:MARKer<1...4>:FUNction:POWer:CFILter	ON OFF	not available for R&S ESCI
R&S ESCI	FSE	CALCulate<1 2>:MARKer<1...4>:FUNction:POWer:PRESet	NADC TETRA PDC PHS CDPD FWCDma RWCDma F8CDma R8CDma F19Cdma R19Cdma FW3Gppcdma RW3Gppcdma D2CDma S2CDma M2CDma NONE	available standards are compatible to the FSE
R&S ESCI		CALCulate<1 2>:MARKer<1...4>:FUNction:POWer:RESult:PHZ	ON OFF	new function for R&S ESCI
R&S ESCI	FSE	CALCulate<1 2>:MARKer<1...4>:FUNction:POWer:RESult?	ACPower CPOWer OBANdwidth OBWidth MCACpower	MCACpower is not available on the FSE MCACpower, ACPower and CPOWer are not available on the FSET
R&S ESCI	FSE	CALCulate<1 2>:MARKer<1...4>:FUNction:POWer:SElect?	ACPower CPOWer OBANdwidth OBWidth CN CN0 MCACpower	MCACpower is not available on the FSE MCACpower, ACPower and CPOWer are not available on the FSET
R&S ESCI	FSE	CALCulate<1 2>:MARKer<1...4>:FUNction:POWer[:STATe]	OFF	
R&S ESCI	FSE	CALCulate<1 2>:MARKer<1...4>:FUNction:REFerence		
	FSE	CALCulate<1 2>:MARKer<1...4>:FUNction:SFACTOR	(60dB/3dB) (60dB/6dB)	not available for R&S ESCI
	FSE	CALCulate<1 2>:MARKer<1...4>:FUNction:SFACTOR:FREQuency?		not available for R&S ESCI
	FSE	CALCulate<1 2>:MARKer<1...4>:FUNction:SFACTOR:RESult?		not available for R&S ESCI
	FSE	CALCulate<1 2>:MARKer<1...4>:FUNction:SFACTOR:STATe	ON OFF	not available for R&S ESCI
	FSE	CALCulate<1 2>:MARKer<1...4>:FUNction:STARt		not available for R&S ESCI
	FSE	CALCulate<1 2>:MARKer<1...4>:FUNction:STOP		not available for R&S ESCI
R&S ESCI		CALCulate<1 2>:MARKer<1...4>:FUNction:STRack: BANDwidth BWIDTH	10 Hz to MAX(span)	new function for R&S ESCI. Replaces DISP:FLINE of the FSE.

Differences in GPIB Behavior between the FSP and the FSE Families of Instruments

Devices		Command (Sheet 11 of 47)	Parameter	Notes
R&S ESCI		CALCulate<1 2>:MARKer<1...4>:FUNctio:n: STRack:THReshold	-330 to +30 dBm	new function for R&S ESCI
R&S ESCI		CALCulate<1 2>:MARKer<1...4>:FUNctio:n: STRack:TRACe	1 to 3	new function for R&S ESCI
R&S ESCI	FSE	CALCulate<1 2>:MARKer<1...4>:FUNctio:n: STRack[:STATe]	ON OFF	
R&S ESCI	FSE	CALCulate<1 2>:MARKer<1...4>:FUNctio:n: SUMMary:AOff		
R&S ESCI	FSE	CALCulate<1 2>:MARKer<1...4>:FUNctio:n: SUMMary:AVERage	ON OFF	
	FSE	CALCulate<1 2>:MARKer<1...4>:FUNctio:n: SUMMary:MAXimum: AVERage:RESult?		not available for R&S ESCI
	FSE	CALCulate<1 2>:MARKer<1...4>:FUNctio:n: SUMMary:MAXimum: PHOLd:RESult?		not available for R&S ESCI
	FSE	CALCulate<1 2>:MARKer<1...4>:FUNctio:n: SUMMary:MAXimum: RESult?		not available for R&S ESCI
	FSE	CALCulate<1 2>:MARKer<1...4>:FUNctio:n: SUMMary:MAXimum [:STATe]	ON OFF	not available for R&S ESCI
R&S ESCI	FSE	CALCulate<1 2>:MARKer<1...4>:FUNctio:n: SUMMary:MEAN: AVERage:RESult?		
R&S ESCI	FSE	CALCulate<1 2>:MARKer<1...4>:FUNctio:n: SUMMary:MEAN: PHOLd:RESult?		
R&S ESCI	FSE	CALCulate<1 2>:MARKer<1...4>:FUNctio:n: SUMMary:MEAN: RESult?		
R&S ESCI	FSE	CALCulate<1 2>:MARKer<1...4>:FUNctio:n: SUMMary:MEAN[:STATe]	ON OFF	
	FSE	CALCulate<1 2>:MARKer<1...4>:FUNctio:n: SUMMary:MIDdle: AVERage:RESult?		not available for R&S ESCI
	FSE	CALCulate<1 2>:MARKer<1...4>:FUNctio:n: SUMMary:MIDdle: PHOLd:RESult?		not available for R&S ESCI
	FSE	CALCulate<1 2>:MARKer<1...4>:FUNctio:n: SUMMary:MIDdle: RESult?		not available for R&S ESCI
	FSE	CALCulate<1 2>:MARKer<1...4>:FUNctio:n: SUMMary:MIDdle [:STATe]	ON OFF	not available for R&S ESCI
R&S ESCI		CALCulate<1 2>:MARKer<1...4>:FUNctio:n: SUMMary:MODE	ABSolute RELative	new function for R&S ESCI
	FSE	CALCulate<1 2>:MARKer<1...4>:FUNctio:n: SUMMary:MPEak: AVERage:RESult?		not available for R&S ESCI
	FSE	CALCulate<1 2>:MARKer<1...4>:FUNctio:n: SUMMary:MPEak: PHOLd:RESult?		not available for R&S ESCI
	FSE	CALCulate<1 2>:MARKer<1...4>:FUNctio:n: SUMMary:MPEak: RESult?		not available for R&S ESCI
	FSE	CALCulate<1 2>:MARKer<1...4>:FUNctio:n: SUMMary:MPEak [:STATe]	ON OFF	not available for R&S ESCI
R&S ESCI	FSE	CALCulate<1 2>:MARKer<1...4>:FUNctio:n: SUMMary:PHOLd	ON OFF	

Differences in GPIB Behavior between the FSP and the FSE Families of Instruments

Devices		Command (<i>Sheet 12 of 47</i>)	Parameter	Notes
R&S ESCI	FSE	CALCulate<1 2>:MARKer<1...4>:FUNction: SUMMary:PPEak: AVERage:RESult?		
R&S ESCI	FSE	CALCulate<1 2>:MARKer<1...4>:FUNction: SUMMary:PPEak:PHOLd:RESult?		
R&S ESCI	FSE	CALCulate<1 2>:MARKer<1...4>:FUNction: SUMMary:PPEak:RESult?		
R&S ESCI	FSE	CALCulate<1 2>:MARKer<1...4>:FUNction: SUMMary:PPEak[:STATe]	ON OFF	
R&S ESCI		CALCulate<1 2>:MARKer<1...4>:FUNction: SUMMary:REFerence: AUTO	ONCE	new function for R&S ESCI
R&S ESCI	FSE	CALCulate<1 2>:MARKer<1...4>:FUNction: SUMMary:RMS:AVERage:RESult?		
R&S ESCI	FSE	CALCulate<1 2>:MARKer<1...4>:FUNction: SUMMary:RMS:PHOLd: RESult?		
R&S ESCI	FSE	CALCulate<1 2>:MARKer<1...4>:FUNction: SUMMary:RMS:RESult?		
R&S ESCI	FSE	CALCulate<1 2>:MARKer<1...4>:FUNction: SUMMary:RMS[:STATe]	ON OFF	
R&S ESCI		CALCulate<1 2>:MARKer<1...4>:FUNction: SUMMary:SDEVIation: RESult?		new function for R&S ESCI
R&S ESCI		CALCulate<1 2>:MARKer<1...4>:FUNction: SUMMary:SDEVIation: AVERage:RESult?		new function for R&S ESCI
R&S ESCI		CALCulate<1 2>:MARKer<1...4>:FUNction: SUMMary:SDEVIation: PHOLd:RESult?		new function for R&S ESCI
R&S ESCI		CALCulate<1 2>:MARKer<1...4>:FUNction: SUMMary:SDEVIation [:STATe]	ON OFF	new function for R&S ESCI
R&S ESCI	FSE	CALCulate<1 2>:MARKer<1...4>:FUNction: SUMMary[:STATe]	ON OFF	
R&S ESCI		CALCulate<1 2>:MARKer<1...4>:FUNction:TOI: RESult?		new function for R&S ESCI
R&S ESCI		CALCulate<1 2>:MARKer<1...4>:FUNction:TOI[: STATe]	ON OFF	new function for R&S ESCI
R&S ESCI	FSE	CALCulate<1 2>:MARKer<1...4>:FUNction: ZOOM	<numeric_value>	R&S ESCI: function uses always marker 1 as its reference marker; FSE: all available markers can be used as a reference marker
R&S ESCI	FSE	CALCulate<1 2>:MARKer<1...4>:LOEXclude	ON OFF	
	FSE	CALCulate<1 2>:MARKer<1...4>:MAXimum: APEak		not available for R&S ESCI
R&S ESCI	FSE	CALCulate<1 2>:MARKer<1...4>:MAXimum:LEFT		
R&S ESCI	FSE	CALCulate<1 2>:MARKer<1...4>:MAXimum: NEXT		

Differences in GPIB Behavior between the FSP and the FSE Families of Instruments

Devices		Command (<i>Sheet 13 of 47</i>)	Parameter	Notes
R&S ESCI	FSE	CALCulate<1 2>:MARKer<1...4>:MAXimum:RIGHT		
R&S ESCI	FSE	CALCulate<1 2>:MARKer<1...4>:MAXimum[:PEAK]		
R&S ESCI	FSE	CALCulate<1 2>:MARKer<1...4>:MINimum:LEFT		
R&S ESCI	FSE	CALCulate<1 2>:MARKer<1...4>:MINimum:NEXT		
R&S ESCI	FSE	CALCulate<1 2>:MARKer<1...4>:MINimum:RIGHT		
R&S ESCI	FSE	CALCulate<1 2>:MARKer<1...4>:MINimum[:PEAK]		
R&S ESCI	FSE	CALCulate<1 2>:MARKer<1...4>:PEXCursion	<numeric_value>	
	FSE	CALCulate<1 2>:MARKer<1...4>:READout	MPHase RIMaginary	not available for R&S ESCI
	FSE	CALCulate<1 2>:MARKer<1...4>:SCOupled[STATe]	ON OFF	not available for R&S ESCI
	FSE	CALCulate<1 2>:MARKer<1...4>:STEP:AUTO	ON OFF	not available for R&S ESCI
	FSE	CALCulate<1 2>:MARKer<1...4>:STEP[:INCRement]	<numeric_value>	not available for R&S ESCI
R&S ESCI	FSE	CALCulate<1 2>:MARKer<1...4>:TRACe	1 to 3	R&S ESCI: 3 traces are available per screen FSE: 4 traces are available in full screen mode and 2 traces per screen in split screen mode
R&S ESCI	FSE	CALCulate<1 2>:MARKer<1...4>:X	0 to MAX (frequency sweep time)	additional unit SYM is available for FSE
R&S ESCI		CALCulate<1 2>:MARKer<1...4>:X:SLIMits:LEFT	0 to MAX (frequency sweep time)	new function for R&S ESCI. Replaces DISP:FLIN and DISP:TLIN commands of the FSE
R&S ESCI		CALCulate<1 2>:MARKer<1...4>:X:SLIMits:RIGHT	0 to MAX (frequency sweep time)	new function for R&S ESCI. Replaces DISP:FLIN and DISP:TLIN commands of the FSE
R&S ESCI	FSE	CALCulate<1 2>:MARKer<1...4>:X:SLIMits[:STATe]	ON OFF	
R&S ESCI	FSE	CALCulate<1 2>:MARKer<1...4>:Y?		
R&S ESCI		CALCulate<1 2>:MARKer<1...4>:Y:PERCent	<numeric_value>	new function for R&S ESCI
R&S ESCI	FSE	CALCulate<1 2>:MARKer<1...4>[:STATe]	ON OFF	

Differences in GPIB Behavior between the FSP and the FSE Families of Instruments

Devices		Command (Sheet 14 of 47)	Parameter	Notes
R&S ESCI		CALCulate<1 2>:MATH:MODE	LINear LOGarithmic	affects all traces on the R&S ESCI; therefore the numeric suffix : MATH<1...4> is not allowed for the R&S ESCI
	FSE	CALCulate<1 2>:MATH<1...4>:MODE	LINear LOGarithmic	for FSE, only the trace indicated by a numeric suffix is affected
R&S ESCI		CALCulate<1 2>:MATH:POS	-100PCT to 200PCT	new function for R&S ESCI; replacement for CALC:RLINE of the FSE
R&S ESCI	FSE	CALCulate<1 2>:MATH:STATe	ON OFF	for R&S ESCI, traces can only be subtracted from trace 1; therefore there is no numeric suffix behind :MATH
R&S ESCI	FSE	CALCulate<1 2>:MATH[:EXPRession][:DEFine]	<expr>	for R&S ESCI, traces can only be subtracted from trace 1; therefore there is no numeric suffix behind :MATH and <expr> may only consist of (TRACE1-TRACE2) or (TRACE1-TRACE3)
	FSE	CALCulate<1 2>:RLINe	MIN to MAX	not available for R&S ESCI (replaced by CALC:MATH:POS)
	FSE	CALCulate<1 2>:RLINe:STATe	ON OFF	not available for R&S ESCI (replaced by CALC:MATH:POS)
R&S ESCI	FSE	CALCulate<1 2>:THReshold	MIN to MAX	
R&S ESCI	FSE	CALCulate<1 2>:THReshold:STATe	ON OFF	
	FSE	CALCulate<1 2>:TLINe<1 2>	0 to 1000s	not available on the R&S ESCI; replaced by CALC:SLIMits:LEFT and CALC:SLIMits:RIGHT
	FSE	CALCulate<1 2>:TLINe<1 2>:STATe	ON OFF	not available on the R&S ESCI; replaced by CALC:SLIMits:LEFT and CALC:SLIMits:RIGHT
	FSE	CALCulate<1 2>:UNIT:ANGLe	DEG RAD	not available for R&S ESCI
R&S ESCI		CALCulate<1 2>:UNIT:POWER	DBM V A W DBPW WATT DBUV DBMV VOLT DBUA AMPere	available units are compatible to the FSE

Differences in GPIB Behavior between the FSP and the FSE Families of Instruments

Devices		Command (<i>Sheet 15 of 47</i>)	Parameter	Notes
	FSET/ ESIB	CALCulate<1 2>:UNIT:POWer	DBM V W DB PCT UNITLESS DBPW WATT DBUV DBMV VOLT DBUA AMPere DBPT DBUV_MHZ DBMV_MHZ DBUA_MHZ DBUV_M DBUA_M DBUV_MMHZ DBUA_MMHZ	the R&S ESCI supports the following units:DBM V A W DBPW WATT DBUV DBMV VOLT DBUA AMPere
	FSE/ FSIQ	CALCulate<1 2>:UNIT:POWer	DBM V W DB PCT UNITLESS DBPW WATT DBUV DBMV VOLT DBUA AMPere DBUV_MHZ DBMV_MHZ DBUA_MHZ DBUV_M DBUA_M DBUV_MMHZ DBUA_MMHZ	the R&S ESCI supports the following units:DBM V A W DBPW WATT DBUV DBMV VOLT DBUA AMPere
	FSE	CALCulate<1 2>:X:UNIT:TIME	S SYM	not available for R&S ESCI
R&S ESCI		CALibration:ABORt		new function for R&S ESCI
	FSE	CALibration:BANDwidth BWIDth[:RESolution]?		not available for R&S ESCI
	FSE	CALibration:IQ?		not available for R&S ESCI
	FSE	CALibration:LDEtector?		not available for R&S ESCI
	FSE	CALibration:LOSuppression?		not available for R&S ESCI
	FSE	CALibration:PPEak?		not available for R&S ESCI
	ESIB	CALibration:PRESelector?		not available for R&S ESCI
		CALibration:RESult?		new function for R&S ESCI
	FSE	CALibration:SHORT?		not available for R&S ESCI
R&S ESCI	FSE	CALibration:STATE	ON OFF	
R&S ESCI	FSE	CALibration[:ALL]?		
	FSE	CONFigure:BURSt:PFERror:COUNT	1 to 1000	not available for R&S ESCI and FSET
	FSE	CONFigure:BURSt:PFERror[IMMediate]		not available for R&S ESCI and FSET
	FSE	CONFigure:BURSt:POWer:CONDition	NORMal EXTReMe	not available for R&S ESCI and FSET

Differences in GPIB Behavior between the FSP and the FSE Families of Instruments

Devices	Command (<i>Sheet 16 of 47</i>)	Parameter	Notes
FSE	CONFigure:BURSt:POWer:COUNT	1 to 1000	not available for R&S ESCI and FSET
FSE	CONFigure:BURSt:POWer[IMMEDIATE]		not available for R&S ESCI and FSET
FSE	CONFigure:BURSt:PTEMplate:[IMMEDIATE]		not available for R&S ESCI and FSET
FSE	CONFigure:BURSt:PTEMplate:COUNT	1 to 1000	not available for R&S ESCI and FSET
FSE	CONFigure:BURSt:PTEMplate:SElect	FULL TOP RISing FALLing	not available for R&S ESCI and FSET
FSE	CONFigure:BURSt:REFerence:AUTO	ON OFF	not available for R&S ESCI and FSET
FSE	CONFigure:SPECtrum:MODulation:COUNT	1 to 1000	not available for R&S ESCI and FSET
FSE	CONFigure:SPECtrum:MODulation:RANGe	ARFCn TXBand RXBand COMBined DCSRx1800	not available for R&S ESCI and FSET
FSE	CONFigure:SPECtrum:MODulation:TGATe	ON OFF	not available for R&S ESCI and FSET
FSE	CONFigure:SPECtrum:MODulation[:IMMEDIATE]		not available for R&S ESCI and FSET
FSE	CONFigure:SPECtrum:SWITChing:COUNT	1 to 1000	not available for R&S ESCI and FSET
FSE	CONFigure:SPECtrum:SWITChing[:IMMEDIATE]		not available for R&S ESCI and FSET
FSE	CONFigure:SPURious:ANTenna	CONDUCTed RADiated	not available for R&S ESCI and FSET
FSE	CONFigure:SPURious:COUN:RXBandt	1 to 1000	not available for R&S ESCI and FSET
FSE	CONFigure:SPURious:COUNT	1 to 1000	not available for R&S ESCI and FSET
FSE	CONFigure:SPURious:RANGe	TXBand OTXBand RXBand IDLeband COMBined	not available for R&S ESCI and FSET
FSE	CONFigure:SPURious:STEP:COUNT?		not available for R&S ESCI and FSET
FSE	CONFigure:SPURious:STEP<1..26>	ON OFF	not available for R&S ESCI and FSET
FSE	CONFigure:SPURious[:IMMEDIATE]		not available for R&S ESCI and FSET
FSE	CONFigure[:BTS]:ARFCn	<numeric_value>	not available for R&S ESCI and FSET
FSE	CONFigure[:BTS]:ARFCn:AUTO	ONCE	not available for R&S ESCI and FSET
FSE	CONFigure[:BTS]:CHANnel:SFH	ON OFF	not available for R&S ESCI and FSET

Differences in GPIB Behavior between the FSP and the FSE Families of Instruments

Devices		Command (<i>Sheet 17 of 47</i>)	Parameter	Notes
	FSE	CONFigure[:BTS]:CHANnel:SLOT	0 to 7	not available for R&S ESCI and FSET
	FSE	CONFigure[:BTS]:CHANnel:SLOT:AUTO	ONCE	not available for R&S ESCI and FSET
	FSE	CONFigure[:BTS]:CHANnel:TSC	0 to 7	not available for R&S ESCI and FSET
	FSE	CONFigure[:BTS]:CHANnel:TSC:AUTO	ON OFF	not available for R&S ESCI and FSET
	FSE	CONFigure[:BTS]:COSiting	ON OFF	not available for R&S ESCI and FSET
	FSE	CONFigure[:BTS]:LIMit:FREqency	<numeric_value>	not available for R&S ESCI and FSET
	FSE	CONFigure[:BTS]:LIMit:PPEak	<numeric_value>	not available for R&S ESCI and FSET
	FSE	CONFigure[:BTS]:LIMit:PRMS	<numeric_value>	not available for R&S ESCI and FSET
	FSE	CONFigure[:BTS]:LIMit:STANdard	ON OFF	not available for R&S ESCI and FSET
	FSE	CONFigure[:BTS]:NETWork:PHASe	1 2[,PLUS]	not available for R&S ESCI and FSET
	FSE	CONFigure[:BTS]:NETWork[:TYPE]	PGSM PGSM900 EGSM EGSM900 DCS GSM1800 PCS GSM1900 RGSM RGSM900	not available for R&S ESCI and FSET
	FSE	CONFigure[:BTS]:POWer:CLASs	1 to 8 1 to 4 M1 M2 M3	not available for R&S ESCI and FSET
	FSE	CONFigure[:BTS]:POWer:COUPled	ON OFF	not available for R&S ESCI and FSET
	FSE	CONFigure[:BTS]:POWer:DYNamic	0 to 15	not available for R&S ESCI and FSET
	FSE	CONFigure[:BTS]:POWer:EXPEcted	<numeric_value>	not available for R&S ESCI and FSET
	FSE	CONFigure[:BTS]:POWer:LIMit	<numeric_value>	not available for R&S ESCI and FSET
	FSE	CONFigure[:BTS]:POWer:SINGLE:CLEar		not available for R&S ESCI and FSET
	FSE	CONFigure[:BTS]:POWer:SINGLE[:STATE]	ON OFF	not available for R&S ESCI and FSET
	FSE	CONFigure[:BTS]:POWer:STATic	0 to 6	not available for R&S ESCI and FSET
	FSE	CONFigure[:BTS]:PRESet		not available for R&S ESCI and FSET
	FSE	CONFigure[:BTS]:SWEeptime	STANdard AUTO	not available for R&S ESCI and FSET
	FSE	CONFigure[:BTS]:TXSupp	ON OFF	not available for R&S ESCI and FSET

Differences in GPIB Behavior between the FSP and the FSE Families of Instruments

Devices	Command (<i>Sheet 18 of 47</i>)	Parameter	Notes
FSE	CONFigure[:BTS]MEASurement?		not available for R&S ESCI and FSET
FSE	CONFigure[:MS]:ARFCn	<numeric_value>	not available for R&S ESCI and FSET
FSE	CONFigure[:MS]:ARFCn:AUTO	ONCE	not available for R&S ESCI and FSET
FSE	CONFigure[:MS]:CHANnel:SFH	ON OFF	not available for R&S ESCI and FSET
FSE	CONFigure[:MS]:CHANnel:TSC	0 to 7	not available for R&S ESCI and FSET
FSE	CONFigure[:MS]:LIMit:FREQuency	<numeric_value>	not available for R&S ESCI and FSET
FSE	CONFigure[:MS]:LIMit:PPEak	<numeric_value>	not available for R&S ESCI and FSET
FSE	CONFigure[:MS]:LIMit:PRMS	<numeric_value>	not available for R&S ESCI and FSET
FSE	CONFigure[:MS]:LIMit:STANdard	ON OFF	not available for R&S ESCI and FSET
FSE	CONFigure[:MS]:NETWork:PHASe	1 2[,PLUS]	not available for R&S ESCI and FSET
FSE	CONFigure[:MS]:NETWork[:TYPE]	PGSM PGSM900 EGSM EGSM900 DCS GSM1800 PCS GSM1900 RGSM RGSM900	not available for R&S ESCI and FSET
FSE	CONFigure[:MS]:POWer:CLASs	<numeric_value>	not available for R&S ESCI and FSET
FSE	CONFigure[:MS]:POWer:COUPled	ON OFF	not available for R&S ESCI and FSET
FSE	CONFigure[:MS]:POWer:EXPEcted	<numeric_value>	not available for R&S ESCI and FSET
FSE	CONFigure[:MS]:POWer:LEVel	0 to 31	not available for R&S ESCI and FSET
FSE	CONFigure[:MS]:POWer:LIMit	<numeric_value>	not available for R&S ESCI and FSET
FSE	CONFigure[:MS]:POWer:SINGLE:CLEar		not available for R&S ESCI and FSET
FSE	CONFigure[:MS]:POWer:SINGLE[:STATe]	ON OFF	not available for R&S ESCI and FSET
FSE	CONFigure[:MS]:POWer:SMALI	ON OFF	not available for R&S ESCI and FSET
FSE	CONFigure[:MS]:PRESet		not available for R&S ESCI and FSET
FSE	CONFigure[:MS]:SWEeptime	STANdard AUTO	not available for R&S ESCI and FSET
FSE	CONFigure[:MS]:TXSupp	ON OFF	not available for R&S ESCI and FSET

Differences in GPIB Behavior between the FSP and the FSE Families of Instruments

Devices		Command (<i>Sheet 19 of 47</i>)	Parameter	Notes
	FSE	CONFigure[:MS]MEASurement?		not available for R&S ESCI and FSET
	FSET	DIAGnostic:INFO:CCOunt:ATTenuation?		not available for R&S ESCI
	FSE	DIAGnostic:INFO:CCOunt:ATTenuation<1 10>?		not available for R&S ESCI
	FSIQ	DIAGnostic:INFO:CCOunt:ATTenuation<1 2 3>?		not available for R&S ESCI
	ESIB	DIAGnostic:INFO:CCOunt:ATTenuation<1 2 4>?		not available for R&S ESCI
	FSE	DIAGnostic:INFO:CCOunt:PRESelector<1..6>?		not available for R&S ESCI
R&S ESCI		DIAGnostic:SERvice:CSOource[:POWer]	<numeric_value>	new function for R&S ESCI
	FSE	DIAGnostic:SERvice:FUNCTion	<numeric_value>, <numeric_value> to	not available for R&S ESCI. Replaced by DIAG:SERV:SFUNCTion
	FSET	DIAGnostic:SERvice:HGENerator	OFF 10 kHz 100 kHz BALanced	not available for R&S ESCI
R&S ESCI		DIAGnostic:SERvice:HWINFO?		new function for R&S ESCI
R&S ESCI	FSE	DIAGnostic:SERvice:INPut[:SElect]	CALibration RF	
R&S ESCI		DIAGnostic:SERvice:INPut:PULSed[:STATe]	ON OFF	new command for R&S ESCI
R&S ESCI		DIAGnostic:SERvice:INPut:PULSed:PRATe	<numeric_value>	new command for R&S ESCI
R&S ESCI	FSE	DIAGnostic:SERvice:NSOource	ON OFF	
R&S ESCI		DIAGnostic:SERvice:SFUNCTion	<string> to	replacement for DIAG:SERV:FUNC of R&S ESCI; necessary due to different parameter formats needed on the R&S ESCI
R&S ESCI		DIAGnostic:SERvice:STESt:RESult?		new function for R&S ESCI
R&S ESCI	FSE	DISPlay:ANNOtation:FREQuency	ON OFF	
		DISPlay:BARGraph:LEVel:LOWer		not available for R&S ESCI
		DISPlay:BARGraph:LEVel:UPPer		not available for R&S ESCI
R&S ESCI	FSE	DISPlay:CMAP<1...26>:DEFault<1 2>		larger selection of independently configurable items (1 to 26)

Differences in GPIB Behavior between the FSP and the FSE Families of Instruments

Devices		Command (<i>Sheet 20 of 47</i>)	Parameter	Notes
R&S ESCI	FSE	DISPlay:CMAP<1...26>:HSL	0 to 1,0 to 1,0 to 1	larger selection of independently configurable items (1 to 26)
R&S ESCI	FSE	DISPlay:CMAP<1...26>:PDEFined	<color>	larger selection of independently configurable items (1 to 26)
R&S ESCI	FSE	DISPlay:FORmat	SINGLE SPLit	
R&S ESCI	FSE	DISPlay:LOGO	ON OFF	
	FSE	DISPlay:PROGram[:MODE]	ON OFF	not available for R&S ESCI
R&S ESCI	FSE	DISPlay:PSAVe:HOLDoff	0 to 60	
R&S ESCI	FSE	DISPlay:PSAVe[:STATe]	ON OFF	
	FSE	DISPlay[:WINDow<1 2>]:FEED	'AF' 'VIDeo'	not available for R&S ESCI
	FSE	DISPlay[:WINDow<1 2>]:MINFo	ON OFF	not available for R&S ESCI
R&S ESCI		DISPlay[:WINDow<1 2>]:SElect		new function for R&S ESCI
R&S ESCI		DISPlay[:WINDow<1 2>]:SIZE	LARGE SMALL	new function for R&S ESCI
R&S ESCI	FSE	DISPlay[:WINDow<1 2>]:TEXT:STATe	ON OFF	
R&S ESCI	FSE	DISPlay[:WINDow<1 2>]:TEXT[:DATA]	<string>	
R&S ESCI	FSE	DISPlay[:WINDow<1 2>]:TIME	ON OFF	
R&S ESCI	FSE	DISPlay[:WINDow<1 2>]:TRACe<1...3>:MODE	WRITE VIEW AVERAge MAXHold MINHold	R&S ESCI: 3 traces are available per screen FSE: 4 traces are available in full screen mode and 2 traces per screen in split screen mode
	FSE	DISPlay[:WINDow<1 2>]:TRACe<1...4>:EYE:COUNT	1 to Result Length	not available for R&S ESCI
	FSE	DISPlay[:WINDow<1 2>]:TRACe<1...4>:MODE:ANALog	ON OFF	not available for R&S ESCI
	FSE	DISPlay[:WINDow<1 2>]:TRACe<1...4>:MODE:CWRite	ON OFF	not available for R&S ESCI
	FSE	DISPlay[:WINDow<1 2>]:TRACe<1...3>:MODE:HCONtinuous	ON OFF	not available for R&S ESCI
	FSE	DISPlay[:WINDow<1 2>]:TRACe<1...4>:SYMBOL	DOTS BARS OFF	not available for R&S ESCI

Differences in GPIB Behavior between the FSP and the FSE Families of Instruments

Devices		Command (<i>Sheet 21 of 47</i>)	Parameter	Notes
	FSE	DISPlay[:WINDow<1 2>]:TRACe<1...4>:X:SPACing	LINear LOGarithmic	not available for R&S ESCI
	FSE	DISPlay[:WINDow<1 2>]:TRACe<1...4>:X[:SCALe]:RVALue	<numeric_value>	not available for R&S ESCI
	FSE	DISPlay[:WINDow<1 2>]:TRACe<1...4>:X[:SCALe]:ZOOM	ON OFF	not available for R&S ESCI
	FSE	DISPlay[:WINDow<1 2>]:TRACe<1...4>:X[:SCALe]:ZOOM[:FREQuency]:CENTer	<numeric_value>	not available for R&S ESCI
	FSE	DISPlay[:WINDow<1 2>]:TRACe<1...4>:X[:SCALe]:ZOOM[:FREQuency]:START	<numeric_value>	not available for R&S ESCI
	FSE	DISPlay[:WINDow<1 2>]:TRACe<1...4>:X[:SCALe]:ZOOM[:FREQuency]:STOP	<numeric_value>	not available for R&S ESCI
R&S ESCI		DISPlay[:WINDow<1 2>]:TRACe<1...3>:Y:SPACing	LINear LOGarithmic LDB	R&S ESCI: TRACe<1...3> LDB is not available for FSE
	FSE	DISPlay[:WINDow<1 2>]:TRACe<1...4>:Y:SPACing	LINear LOGarithmic PERCent	PERCent is not available for R&S ESCI FSE: TRACE<1...4>
R&S ESCI	FSE	DISPlay[:WINDow<1 2>]:TRACe<1...3>:Y[:SCALe]	10dB to 200dB	R&S ESCI: TRACe<1...3> FSE: TRACE<1...4>
	FSET/ESIB	DISPlay[:WINDow<1 2>]:TRACe<1...4>:Y[:SCALe]:BOTTom	<numeric_value>	not available for R&S ESCI
R&S ESCI	FSE	DISPlay[:WINDow<1 2>]:TRACe<1...3>:Y[:SCALe]:MODE	ABSolute RELative	R&S ESCI: TRACe<1...3> FSE: TRACE<1...4>
	FSE	DISPlay[:WINDow<1 2>]:TRACe<1...4>:Y[:SCALe]:PDIVision		not available for R&S ESCI
R&S ESCI	FSE	DISPlay[:WINDow<1 2>]:TRACe<1...3>:Y[:SCALe]:RLEVel	-130dBm to 30dBm	R&S ESCI: TRACe<1...3> FSE: TRACE<1...4>
R&S ESCI	FSE	DISPlay[:WINDow<1 2>]:TRACe<1...3>:Y[:SCALe]:RLEVel:OFFSet	-200dB to 200dB	R&S ESCI: TRACe<1...3> FSE: TRACE<1...4>
R&S ESCI	FSE	DISPlay[:WINDow<1 2>]:TRACe<1...3>:Y[:SCALe]:RPOStion	0 to 100 PCT	R&S ESCI: TRACe<1...3> FSE: TRACE<1...4>
R&S ESCI	FSE	DISPlay[:WINDow<1 2>]:TRACe<1...3>:Y[:SCALe]:RVALue	<numeric_value>	R&S ESCI: TRACe<1...3> FSE: TRACE<1...4>
	FSE	DISPlay[:WINDow<1 2>]:TRACe<1...4>:Y[:SCALe]:RVALue:AUTO	ON OFF	not available for R&S ESCI
	FSET/ESIB	DISPlay[:WINDow<1 2>]:TRACe<1...4>:Y[:SCALe]:TOP	<numeric_value>	not available for R&S ESCI

Differences in GPIB Behavior between the FSP and the FSE Families of Instruments

Devices		Command (<i>Sheet 22 of 47</i>)	Parameter	Notes
R&S ESCI		DISPlay[:WINDow<1 2>]:TRACe<1...3>[:STATe]	ON OFF	R&S ESCI: TRACe<1...3> FSE: TRACE<1...4>
	FSE	FETCh:BURSt:FERRor:AVERage?		not available for R&S ESCI and FSET
	FSE	FETCh:BURSt:FERRor:MAXimum?		not available for R&S ESCI and FSET
	FSE	FETCh:BURSt:FERRor:STATus?		not available for R&S ESCI and FSET
	FSE	FETCh:BURSt:PERRor:PEAK:AVERage?		not available for R&S ESCI and FSET
	FSE	FETCh:BURSt:PERRor:PEAK:MAXimum?		not available for R&S ESCI and FSET
	FSE	FETCh:BURSt:PERRor:PEAK:STATus?		not available for R&S ESCI and FSET
	FSE	FETCh:BURSt:PERRor:RMS:AVERage?		not available for R&S ESCI and FSET
	FSE	FETCh:BURSt:PERRor:RMS:MAXimum?		not available for R&S ESCI and FSET
	FSE	FETCh:BURSt:PERRor:RMS:STATus?		not available for R&S ESCI and FSET
	FSE	FETCh:BURSt:POWer[:IMMediate]?		not available for R&S ESCI and FSET
	FSE	FETCh:MODulation[:ALL]?	ARFCn TXBand RXBand COMBined DCSRx1800	not available for R&S ESCI and FSET
	FSE	FETCh:PTEMplate:REFerence?	TXBand	not available for R&S ESCI and FSET
	FSE	FETCh:SPECTrum:MODulation:REFerence?	TXBand	not available for R&S ESCI and FSET
	FSE	FETCh:SPECTrum:SWITChing:REFerence?	TXBand	not available for R&S ESCI and FSET
	FSE	FETCh:SPECTrum:SWITChing[:ALL]?		not available for R&S ESCI and FSET
	FSE	FETCh:SPURious:STEP?		not available for R&S ESCI and FSET
	FSE	FETCh:SPURious[:ALL]?	TXBand OTXBand RXBand IDLeband	not available for R&S ESCI and FSET
	FSE	FORMat:DEXPort:APPend[:STATe] ON OFF[,32]		not available for R&S ESCI
R&S ESCI	FSE	FORMat:DEXPort:DSEParator	POINT COMMa	
	FSE	FORMat:DEXPort:HEADer[:STATe] ON OFF[,32]		not available for R&S ESCI
R&S ESCI		FORMat[:DATA]	ASCIi REAL[,32]	

Differences in GPIB Behavior between the FSP and the FSE Families of Instruments

Devices		Command (<i>Sheet 23 of 47</i>)	Parameter	Notes
	FSE	FORMat[:DATA]	ASCIi REAL UINT [,32]	UINT is not available for R&S ESCI
R&S ESCI	FSE	HCOPY:ABORt		
R&S ESCI		HCOPY:CMAP:DEFault		new function for R&S ESCI
R&S ESCI		HCOPY:CMAP:HSL	<numeric_value>, <numeric_value>, <numeric_value>	new function for R&S ESCI
R&S ESCI		HCOPY:CMAP:PDEFined	<char data>	new function for R&S ESCI
R&S ESCI		HCOPY:DESTination<1 2>	'MMEM' 'SYST:COMM: PRIN' 'SYST:COMM: CLIP'	
	FSE/ FSET	HCOPY:DESTination<1 2>	'SYST:COMM:GPIB' 'SYST:COMM:SER1' 'SYST:COMM:SER2' 'SYST:COMM:CENT' 'MMEM' 'SYST:COMM: PRIN' 'SYST:COMM: CLIP'	SYST:COMM:GPIB/ SER1/SER2 is not available for R&S ESCI
	FSIQ/ ESIB	HCOPY:DESTination<1 2>	'MMEM' 'SYST:COMM: PRIN' 'SYST:COMM: CLIP'	
R&S ESCI	FSE	HCOPY:DEVIce:COLor	ON OFF	
R&S ESCI		HCOPY:DEVIce:LANGUage<1 2>	GDI WMF EWMF BMP	
	FSE/ FSET	HCOPY:DEVIce:LANGUage<1 2>	HPGL PCL4 PCL5 POSTscript ESCP WMF PCX HP7470 to	
	FSIQ/ ESIB	HCOPY:DEVIce:LANGUage<1 2>	WMF GDI EWMF BMP to	
	FSE/ FSET	HCOPY:DEVIce:PRESet<1 2>	ON OFF	not available for R&S ESCI
	FSE/ FSET	HCOPY:DEVIce:RESolution<1 2>	150 300	not available for R&S ESCI
R&S ESCI	FSE	HCOPY:ITEM:ALL		
	FSE	HCOPY:ITEM:FFEed<1 2>:STATe	ON OFF	not available for R&S ESCI
	FSE	HCOPY:ITEM:LABel:TEXT	<string>	not available for R&S ESCI
	FSE	HCOPY:ITEM:PFEed<1 2>:STATe	ON OFF	not available for R&S ESCI
R&S ESCI	FSE	HCOPY:ITEM:WINDow<1 2>:TABLe:STATe	ON OFF	
R&S ESCI	FSE	HCOPY:ITEM:WINDow<1 2>:TEXT	<string>	

Differences in GPIB Behavior between the FSP and the FSE Families of Instruments

Devices		Command (<i>Sheet 24 of 47</i>)	Parameter	Notes
	FSE	HCOPY:ITEM:WINDow<1 2>:TRACe:CAINcrement	ON OFF	not available for R&S ESCI
R&S ESCI	FSE	HCOPY:ITEM:WINDow<1 2>:TRACe:STATe	ON OFF	
	FSE	HCOPY:PAGE:DIMensions:FULL		not available for R&S ESCI
	FSE	HCOPY:PAGE:DIMensions:QUADrant<1...4>		not available for R&S ESCI
R&S ESCI	FSE	HCOPY:PAGE:ORIENTATION<1 2>	LANDscape PORTRait	
R&S ESCI	FSE	HCOPY[:IMMEDIATE]		
	FSET/ ESIB	HOLD		not available for R&S ESCI
R&S ESCI	FSE	INITiate<1 2>:CONMeas	ON OFF	
R&S ESCI	FSE	INITiate<1 2>:CONTInuous	ON OFF	
R&S ESCI	FSE	INITiate<1 2>:DISPlay	ON OFF	
R&S ESCI	FSE	INITiate<1 2>[:IMMEDIATE]		
	FSET	INPut:PRESelection:CATalog?		not available for R&S ESCI
	FSET	INPut:PRESelection:USET:NAME	'name of user defined preselector set (to edit existing set or to create new set)'	not available for R&S ESCI
	FSET	INPut:PRESelection:USET:CLEar		not available for R&S ESCI
	FSET	INPut:PRESelection:USET:COMMeNt	'comment for preselector-set'	not available for R&S ESCI
	FSET	INPut:PRESelection:USET:LRANge[:DATA]	<numeric_value>, <numeric_value>, <numeric_value>	not available for R&S ESCI
	FSET	INPut:PRESelection:USET:MRANge[:DATA]	<numeric_value>, <numeric_value>, <numeric_value>	not available for R&S ESCI
R&S ESCI	FSE	INPut<1 2>:ATTenuation	0 to 70dB	
	FSET	INPut<1 2>:ATTenuation	0 to 70 80dB	80 dB not available for R&S ESCI
R&S ESCI	FSE	INPut<1 2>:ATTenuation:AUTO	ON OFF	

Differences in GPIB Behavior between the FSP and the FSE Families of Instruments

Devices		Command (<i>Sheet 25 of 47</i>)	Parameter	Notes
R&S ESCI	FSE	INPut<1 2>:ATTenuation:AUTO:MODE	NORMal LNOise LDIStorsion	not available for models 3 and 7; not available for R&S ESCI
	FSET/ ESIB	INPut<1 2>:ATTenuation:PROTection	ON OFF	not available for R&S ESCI
R&S ESCI		INPut<1 2>:ATTenuation:PROTection:PRESet		new function for R&S ESCI
	FSET	INPut<1 2>:ATTenuation:STEPsize	1dB 10dB	not available for R&S ESCI
	FSET	INPut<1 2>:BIMPedance	150OHM 600OHM 10kOHM	not available for R&S ESCI
	FSET	INPut<1 2>:COUPling	AC DC	only available for R&S ESCI models 3, 8, 26
		INPut<1 2>:EATT	0 to 30dB	new function for R&S ESCI
		INPut<1 2>:EATT:AUTO	ON OFF	new function for R&S ESCI
		INPut<1 2>:EATT:STATe	ON OFF	new function for R&S ESCI
	FSET	INPut<1 2>:GAIN	0 to 30dB	not available for R&S ESCI
	FSET/ ESIB	INPut<1 2>:GAIN:AUTO	ON OFF	not available for R&S ESCI
R&S ESCI	FSE	INPut<1 2>:GAIN:STATe	ON OFF	
R&S ESCI	FSE	INPut<1 2>:IMPedance	50 75	
	FSE	INPut<1 2>:IMPedance:CORRection	RAM RAZ	not available for R&S ESCI
	FSET	INPut<1 2>:LISN:PEARth	GROunded FLOating	not available for R&S ESCI
	FSET	INPut<1 2>:LISN:PHASe	L1 L2 L3 N	not available for R&S ESCI
	FSET	INPut<1 2>:LISN[:TYPE]	TWOphase FOURphase OFF	not available for R&S ESCI
R&S ESCI	FSE	INPut<1 2>:MIXer	<numeric_value>	not available for R&S ESCI
	FSET	INPut<1 2>:PRESelection:COUPling	ON OFF	not available for R&S ESCI
	FSET	INPut<1 2>:PRESelection:COUPling:HIGH: FREQUency	5MHz to 500MHz	not available for R&S ESCI
	FSET	INPut<1 2>:PRESelection:COUPling:HIGH:SET	'name of preselector set for high RBW'	not available for R&S ESCI

Differences in GPIB Behavior between the FSP and the FSE Families of Instruments

Devices		Command (<i>Sheet 26 of 47</i>)	Parameter	Notes
	FSET	INPut<1 2>:PRESelection:COUPling:LOW:FREQUency	10Hz to 5MHz	not available for R&S ESCI
	FSET	INPut<1 2>:PRESelection:COUPling:LOW:SET	'name of preselector set for low RBW'	not available for R&S ESCI
	FSET	INPut<1 2>:PRESelection:COUPling:MID:SET	'name of preselector set for medium RBW'	not available for R&S ESCI
	FSET	INPut<1 2>:PRESelection:FILTer:HPASS[:FREQUency]	100Hz to 5MHz	not available for R&S ESCI
	FSET	INPut<1 2>:PRESelection:FILTer:LPASS[:FREQUency]	20KHz to 40MHz	not available for R&S ESCI
	FSET	INPut<1 2>:PRESelection:FILTer[:STATe]	ON OFF	not available for R&S ESCI
	FSET	INPut<1 2>:PRESelection:SET	NARRow NORMal WIDE	not available for R&S ESCI
	FSET	INPut<1 2>:PRESelection:USET[:SElect]	'name of user defined preselector set'	not available for R&S ESCI
	FSET	INPut<1 2>:PRESelection[:STATe]	ON OFF	not available for R&S ESCI
	FSET	INPut<1 2>:TYPE	RF BALanced	not available for R&S ESCI
	ESIB	INPut<1 2>:TYPE	INPUT1 INPUT2	not available for R&S ESCI
	FSE	INPut<1 2>:UPORt<1 2>:STATe	ON OFF	not available for R&S ESCI
	FSE	INPut<1 2>:UPORt<1 2>[:VALue]?		not available for R&S ESCI
	ESIB	INPut2:COUPling	AC DC	not available for R&S ESCI
		INSTRument:COUPlE	NONE RLeVel CF_B CF_A	available coupling modes between Screen A and Screen B have been changed between FSE and R&S ESCI
	FSE	INSTRument:COUPlE	NONE MODE X Y CONTRol XY XCONTRol YCONTRol ALL	Available coupling modes between screen A and screen B have been changed between FSE and R&S ESCI
		INSTRument<1 2>:NSElect	1	currently only parameter value 1 available
	ESIB	INSTRument<1 2>:NSElect	1 to 3 6	4 parameter values are available
	FSE/ FSIQ	INSTRument<1 2>:NSElect	1 to 5	5 parameter values are available
	FSET	INSTRument<1 2>:NSElect	1 2 6	3 parameter values are available
		INSTRument<1 2>[:SElect]	SANalyzer	Currently only SANalyzer available

Differences in GPIB Behavior between the FSP and the FSE Families of Instruments

Devices		Command (<i>Sheet 27 of 47</i>)	Parameter	Notes
	FSE/ FSIQ	INSTrument<1 2>[:SElect]	SANalyzer DDEMod ADEMod BGSM MGSM	5 parameters are available.
	ESIB	INSTrument<1 2>[:SElect]	RECeiver SANalyzer DDEMod ADEMod	4 parameters are available.
	FSET	INSTrument<1 2>[:SElect]	ANalyzer DDEMod RECeiver	3 parameters are available.
R&S ESCI	FSE	MMEMory:CATalog?	string	
R&S ESCI	FSE	MMEMory:CDIRectory	directory name	
R&S ESCI	FSE	MMEMory:CLear:ALL		
R&S ESCI	FSE	MMEMory:CLear:STATe	1,path	
R&S ESCI	FSE	MMEMory:COMMent	<string>	
R&S ESCI	FSE	MMEMory:COpy	path\file, path\file	
R&S ESCI	FSE	MMEMory:DATA	filename[, <block data>]	
R&S ESCI	FSE	MMEMory:DELeTe	path\filename	
R&S ESCI	FSE	MMEMory:LOAD:AUTO	1,path	
R&S ESCI	FSE	MMEMory:LOAD:STATe	1,path	
R&S ESCI	FSE	MMEMory:MDIRectory	path	
R&S ESCI	FSE	MMEMory:MOVE	path	
R&S ESCI	FSE	MMEMory:NAME	path\filename	
R&S ESCI	FSE	MMEMory:RDIRectory	directory	
R&S ESCI	FSE	MMEMory:SElect[:ITEM]:ALL		
	FSE	MMEMory:SElect[:ITEM]:CSEtUp	ON OFF	not available for R&S ESCI (default setting on the R&S ESCI)
	FSE	MMEMory:SElect[:ITEM]:CVL:ALL	ON OFF	not available for R&S ESCI and FSET
	FSE	MMEMory:SElect[:ITEM]:CVL[:ACTive]	ON OFF	not available for R&S ESCI and FSET
R&S ESCI	FSE	MMEMory:SElect[:ITEM]:DEFault		

Differences in GPIB Behavior between the FSP and the FSE Families of Instruments

Devices		Command (<i>Sheet 28 of 47</i>)	Parameter	Notes
	FSE	MMEMory:SElect[:ITEM]:GSEtUp	ON OFF	not available for R&S ESCI (default setting on the R&S ESCI)
	FSE	MMEMory:SElect[:ITEM]:HCOPy	ON OFF	not available for R&S ESCI (default setting on the R&S ESCI)
R&S ESCI	FSE	MMEMory:SElect[:ITEM]:HWSettings	ON OFF	
R&S ESCI	FSE	MMEMory:SElect[:ITEM]:LINes:ALL	ON OFF	
	FSE	MMEMory:SElect[:ITEM]:LINes:ALL	ON OFF	
	FSE	MMEMory:SElect[:ITEM]:LINes[:ACTive]	ON OFF	not available for R&S ESCI (default setting on the R&S ESCI)
	FSE	MMEMory:SElect[:ITEM]:MACROs	ON OFF	not available for R&S ESCI
R&S ESCI	FSE	MMEMory:SElect[:ITEM]:NONE		
R&S ESCI	FSE	MMEMory:SElect[:ITEM]:SCData	ON OFF	
R&S ESCI		MMEMory:SElect[:ITEM]:TRACe[:ACTive]	ON OFF	no numeric suffixes behind TRACe
	FSE	MMEMory:SElect[:ITEM]:TRACe<1...4>	ON OFF	numeric suffixes behind TRACe
	FSE	MMEMory:SElect[:ITEM]:TRANsducer:ALL	ON OFF	not available for R&S ESCI
	FSE	MMEMory:SElect[:ITEM]:TRANsducer[:ACTive]	ON OFF	not available for R&S ESCI
R&S ESCI	FSE	MMEMory:STORe:STATe	1,path	
R&S ESCI	FSE	MMEMory:STORe:TRACe	1 to 3,path	
	FSE	OUTPut:AF:SENSitivity	<numeric_value>	not available for R&S ESCI and FSET
	FSE	OUTPut:UPOrt<1 2>:STATe	ON OFF	not available for R&S ESCI
	FSE	OUTPut:UPOrt<1 2>[:VALue]	#B00000000 to #B11111111	not available for R&S ESCI
R&S ESCI	FSE	OUTPut<1 2>[:STATe]	ON OFF	
	FSE	READ:BURSt:FERRor:AVERAge?		not available for R&S ESCI and FSET
	FSE	READ:BURSt:FERRor:MAXimum?		not available for R&S ESCI and FSET

Differences in GPIB Behavior between the FSP and the FSE Families of Instruments

Devices		Command (<i>Sheet 29 of 47</i>)	Parameter	Notes
	FSE	READ:BURSt:FERRor:STATus?		not available for R&S ESCI and FSET
	FSE	READ:BURSt:PERRor:PEAK:AVERAge?		not available for R&S ESCI and FSET
	FSE	READ:BURSt:PERRor:PEAK:MAXimum?		not available for R&S ESCI and FSET
	FSE	READ:BURSt:PERRor:PEAK:STATus?		not available for R&S ESCI and FSET
	FSE	READ:BURSt:PERRor:RMS:AVERAge?		not available for R&S ESCI and FSET
	FSE	READ:BURSt:PERRor:RMS:MAXimum?		not available for R&S ESCI and FSET
	FSE	READ:BURSt:PERRor:RMS:STATus?		not available for R&S ESCI and FSET
	FSE	READ:BURSt:POWer:DYNamic?		not available for R&S ESCI and FSET
	FSE	READ:BURSt:POWer:LEVel?		not available for R&S ESCI and FSET
	FSE	READ:BURSt:POWer:STATic?		not available for R&S ESCI and FSET
	FSE	READ:BURSt:POWer?		not available for R&S ESCI and FSET
	FSE	READ:BURSt:REFerence[:IMMediate?]		not available for R&S ESCI and FSET
	FSE	READ:SPECTrum:MODulation[:ALL]?		not available for R&S ESCI and FSET
	FSE	READ:SPECTrum:SWITChing[:ALL]?		not available for R&S ESCI and FSET
	FSE	READ:SPURious:STEP?		not available for R&S ESCI and FSET
	FSE	READ:SPURious[:ALL]?		not available for R&S ESCI and FSET
	FSE	[SENSe<1 2>:]ADEMod:AF:COUPling	AC DC	not available for R&S ESCI and FSET
	FSE	[SENSe<1 2>:]ADEMod:RTIME	ON OFF	not available for R&S ESCI and FSET
	FSE	[SENSe<1 2>:]ADEMod:SBANd	NORMal INVerse	not available for R&S ESCI and FSET
	FSE	[SENSe<1 2>:]ADEMod:SQUelch:LEVel	30 to 150 dBm	not available for R&S ESCI and FSET
	FSE	[SENSe<1 2>:]ADEMod:SQUelch[:STATE]	ON OFF	not available for R&S ESCI and FSET
	FSET	[SENSe<1 2>:]AM:RANGe[:UPPer]	3PCT 10 PCT 100PCT	not available for R&S ESCI
	FSE	[SENSe<1 2>:]AVERAge:AUTO	ON OFF	not available for R&S ESCI

Differences in GPIB Behavior between the FSP and the FSE Families of Instruments

Devices		Command (<i>Sheet 30 of 47</i>)	Parameter	Notes
R&S ESCI	FSE	[SENSe<1 2>:]AVERAge:COUNT	0 to 32767	
	FSE	[SENSe<1 2>:]AVERAge:COUNT	0 to 32767	
R&S ESCI		[SENSe<1 2>:]AVERAge:TYPE	VIDeo LINear	command is used to select logarithmic or linear averaging on the R&S ESCI; therefore parameters are incompatible to the FSE
	FSE	[SENSe<1 2>:]AVERAge:TYPE	MAXimum MINimum SCALar	command is used to select logarithmic or linear averaging on the R&S ESCI; therefore parameters are incompatible to the FSE
R&S ESCI	FSE	[SENSe<1 2>:]AVERAge[:STATe<1...3>]	ON OFF	
	FSE	[SENSe<1 2>:]BANDwidth BWIDth:DEMod	<numeric_value>	not available for R&S ESCI and FSET
	FSE	[SENSe<1 2>:]BANDwidth BWIDth:PLL	AUTO HIGH MEDium LOW	not available for R&S ESCI
R&S ESCI	FSE	[SENSe<1 2>:]BANDwidth BWIDth:VIDeo	1Hz to 10MHz	
	FSET	[SENSe<1 2>:]BANDwidth BWIDth:VIDeo	1Hz to 500MHz	
R&S ESCI	FSE	[SENSe<1 2>:]BANDwidth BWIDth:VIDeo:AUTO	ON OFF	
	FSET	[SENSe<1 2>:]BANDwidth BWIDth:VIDeo:EXTernal[:STATe]	ON OFF	not available for R&S ESCI
R&S ESCI		[SENSe<1 2>:]BANDwidth BWIDth:VIDeo:RATio	0.0001 to 1	only numeric values available. Parameter ranges differ between R&S ESCI and FSE
	FSE	[SENSe<1 2>:]BANDwidth BWIDth:VIDeo:RATio	0.001 to 1000 SINE PULSE NOISE	also text parameters are available. Parameter ranges differ between R&S ESCI and FSE not available for FSET
R&S ESCI	FSE	[SENSe<1 2>:]BANDwidth BWIDth[:RESolution]	10Hz to 10MHz (anal. filter) 1Hz to 10MHz (FFT filter)	FSE: 10Hz to 10MHz (models 20) 1Hz to 10MHz (models 30)
	FSET	[SENSe<1 2>:]BANDwidth BWIDth[:RESolution]	10 Hz to 500MHz	
R&S ESCI	FSE	[SENSe<1 2>:]BANDwidth BWIDth[:RESolution]:AUTO	ON OFF	
	FSE	[SENSe<1 2>:]BANDwidth BWIDth[:RESolution]:MODE	ANALog DIGital	not available for R&S ESCI and FSET

Differences in GPIB Behavior between the FSP and the FSE Families of Instruments

Devices		Command (<i>Sheet 31 of 47</i>)	Parameter	Notes
R&S ESCI	FSE	[SENSe<1 2>:]BANDwidth BWIDth[:RESolution]: MODE:FFT	ON OFF	old command that is still supported, but has been replaced on the R&S ESCI by [SENSe<1 2>:]BANDwidth BWIDth[:RESolution]:TYPE
R&S ESCI	FSE	[SENSe<1 2>:]BANDwidth BWIDth[:RESolution]: RATio	0.0001 to 1	
R&S ESCI		[SENSe<1 2>:]BANDwidth BWIDth[:RESolution]: TYPE	NORMal FFT CFILter RRC	new function for R&S ESCI
R&S ESCI		[SENSe<1 2>:]BANDwidth BWIDth:VIDeo:TYPE	LINear LOGarithmic	new function for R&S ESCI
R&S ESCI	FSE	[SENSe<1 2>:]CORRection:COLLect[:ACQuire]	THRough OPEN	
	FSE	[SENSe<1 2>:]CORRection:CVL:BAND	A Q U V E W F D G Y J	not available for R&S ESCI and FSET
	FSE	[SENSe<1 2>:]CORRection:CVL:BIAS	<numeric_value>	not available for R&S ESCI and FSET
	FSE	[SENSe<1 2>:]CORRection:CVL:CATalog?		not available for R&S ESCI and FSET
	FSE	[SENSe<1 2>:]CORRection:CVL:CLear		not available for R&S ESCI and FSET
	FSE	[SENSe<1 2>:]CORRection:CVL:COMMeNt	<string>	not available for R&S ESCI and FSET
	FSE	[SENSe<1 2>:]CORRection:CVL:DATA	<freq>, <level> to	not available for R&S ESCI and FSET
	FSE	[SENSe<1 2>:]CORRection:CVL:MIXer	<string>	not available for R&S ESCI and FSET
	FSE	[SENSe<1 2>:]CORRection:CVL:PORTs	2 3	not available for R&S ESCI and FSET
	FSE	[SENSe<1 2>:]CORRection:CVL:SELeCt	<file_name>	not available for R&S ESCI and FSET
	FSE	[SENSe<1 2>:]CORRection:CVL:SNUMber	<string>	not available for R&S ESCI and FSET
	FSE	[SENSe<1 2>:]CORRection:CVL:TYPE	ODD EVEN EODD	not available for R&S ESCI and FSET
	FSE/ FSIQ	[SENSe<1 2>:]CORRection:LOSS:INPut[: MAGNitude]	<numeric_value>	not available for R&S ESCI
R&S ESCI	FSE	[SENSe<1 2>:]CORRection:METhod	TRANsmission REFLeXion	
R&S ESCI	FSE	[SENSe<1 2>:]CORRection:RECall		
	FSE	[SENSe<1 2>:]CORRection:RXGain:INPut[: MAGNitude]	<numeric_value>	not available for R&S ESCI, FSET and ESIB
R&S ESCI	FSE	[SENSe<1 2>:]CORRection[::STATe]	ON OFF	

Differences in GPIB Behavior between the FSP and the FSE Families of Instruments

Devices		Command (<i>Sheet 32 of 47</i>)	Parameter	Notes
R&S ESCI	FSE	[SENSe<1 2>:]CORRection:TRANsducer:ACTive?		
R&S ESCI	FSE	[SENSe<1 2>:]CORRection:TRANsducer: CATalog?		
R&S ESCI	FSE	[SENSe<1 2>:]CORRection:TRANsducer: COMMeNt	<string>	
R&S ESCI	FSE	[SENSe<1 2>:]CORRection:TRANsducer:DATA	<freq>,<level> to	
R&S ESCI	FSE	[SENSe<1 2>:]CORRection:TRANsducer:DELeTe		
R&S ESCI	FSE	[SENSe<1 2>:]CORRection:TRANsducer: SCALing	LINear LOGarithmic	
R&S ESCI	FSE	[SENSe<1 2>:]CORRection:TRANsducer:SELeCt	<name>	
R&S ESCI	FSE	[SENSe<1 2>:]CORRection:TRANsducer:UNIT	<string>	
R&S ESCI	FSE	[SENSe<1 2>:]CORRection:TRANsducer[:STATe]	ON OFF	
	FSE	[SENSe<1 2>:]CORRection:TSET:ACTive?		not available for R&S ESCI
	FSE	[SENSe<1 2>:]CORRection:TSET:BReAk	ON OFF	not available for R&S ESCI
	FSE	[SENSe<1 2>:]CORRection:TSET:CATalog?		not available for R&S ESCI
	FSE	[SENSe<1 2>:]CORRection:TSET:COMMeNt	<string>	not available for R&S ESCI
	FSE	[SENSe<1 2>:]CORRection:TSET:DELeTe		not available for R&S ESCI
	FSE	[SENSe<1 2>:]CORRection:TSET: RANGe<1...10>	<freq>,<freq>,<name> to	not available for R&S ESCI
	FSE	[SENSe<1 2>:]CORRection:TSET:SELeCt	<name>	not available for R&S ESCI
	FSE	[SENSe<1 2>:]CORRection:TSET:UNIT	<string>	not available for R&S ESCI
	FSE	[SENSe<1 2>:]CORRection:TSET[:STATe]	ON OFF	not available for R&S ESCI
R&S ESCI	FSE	[SENSe<1 2>:]CORRection:YIG:TEMPeRature: AUTO	ON OFF	new function for R&S ESCI
	FSE	[SENSe<1 2>:]DDEMod:FiLTeR:ALPHa	0.2 to 1	not available for R&S ESCI
	FSE	[SENSe<1 2>:]DDEMod:FiLTeR:MEASurement	OFF RCOSine RRCosine GAUSSian B22 B25 B44 QFM QFR QRM QRR A25Fm EMES EREF	not available for R&S ESCI

Differences in GPIB Behavior between the FSP and the FSE Families of Instruments

Devices		Command (<i>Sheet 33 of 47</i>)	Parameter	Notes
	FSE	[SENSe<1 2>:]DDEMod:FiLTeR:REFEreNce	RCOSine RRCosine GAUSSian B22 B25 B44 QFM QFR QRM QRR A25Fm EMES EREF	not available for R&S ESCI
	FSE	[SENSe<1 2>:]DDEMod:FORMat	QPSK PSK MSK QAM FSK	not available for R&S ESCI
	FSE	[SENSe<1 2>:]DDEMod:FSK:NSTate	2 4	not available for R&S ESCI
	FSE	[SENSe<1 2>:]DDEMod:MSK:FORMat	TYPE1 TYPE2 NORMAl DiFFerential	not available for R&S ESCI
	FSE	[SENSe<1 2>:]DDEMod:NORMAlize	ON OFF	not available for R&S ESCI
	FSE	[SENSe<1 2>:]DDEMod:PRATe	1 2 4 8 16	not available for R&S ESCI
	FSE/ ESIB	[SENSe<1 2>:]DDEMod:PRESet	GSM EDGe NADC TETRa DCS1800 PCS1900 PHS PDCup PDCDown APCO25CQPSK APCO25C4FM CDPD DECT CT2 ERMes MODacom PWT TFTS F16 F322 F324 F64 FQCDma RQCDma FNADc RNADc BPSK18 GMSK18 QPSK18 GMSK36	not available for R&S ESCI
	FSIQ	[SENSe<1 2>:]DDEMod:PRESet	GSM EDGe NADC TETRa PHS PDCup PDCDown APCO25CQPSK APCO25C4FM CDPD DECT CT2 ERMes MODacom PWT TFTS F16 F322 F324 F64 FWCDma RWCDma FW3Gppcdma RW3Gppcdma BPSK18 GMSK18 QPSK18 GMSK36	not available for R&S ESCI
	FSET	[SENSe<1 2>:]DDEMod:PRESet	GSM EDGe NADC TETRa DCS1800 PCS1900 PHS PDCup PDCDown APCO25CQPSK APCO25C4FM CDPD DECT CT2 ERMes MODacom PWT TFTS F16 F322 F324 F64 FQCDma RQCDma FNADc RNADc BPSK18 GMSK18 QPSK18 GMSK36	not available for R&S ESCI
	FSE	[SENSe<1 2>:]DDEMod:PSK:FORMat	NORMAl DiFFerential N3Pi8	not available for R&S ESCI

Differences in GPIB Behavior between the FSP and the FSE Families of Instruments

Devices		Command (<i>Sheet 34 of 47</i>)	Parameter	Notes
	FSE	[SENSe<1 2>:]DDEMod:PSK:NState	2 8	not available for R&S ESCI
	FSE	[SENSe<1 2>:]DDEMod:QAM:NState	16	not available for R&S ESCI
	FSE	[SENSe<1 2>:]DDEMod:QPSK:FORMat	NORMal DIFFerential OFFSet DPI4	not available for R&S ESCI
	FSE	[SENSe<1 2>:]DDEMod:SBANd	NORMal INVerse	not available for R&S ESCI
	FSE	[SENSe<1 2>:]DDEMod:SEARch:PULSe:STATe	ON OFF	not available for R&S ESCI
	FSE	[SENSe<1 2>:]DDEMod:SEARch:SYNC:CATalog?		not available for R&S ESCI
	FSE	[SENSe<1 2>:]DDEMod:SEARch:SYNC:COMMeNt	<string>	not available for R&S ESCI
	FSE	[SENSe<1 2>:]DDEMod:SEARch:SYNC:DATA	<string>	not available for R&S ESCI
	FSE	[SENSe<1 2>:]DDEMod:SEARch:SYNC:NAME	<string>	not available for R&S ESCI
	FSE	[SENSe<1 2>:]DDEMod:SEARch:SYNC:OFFSet	<numeric_value>	not available for R&S ESCI
	FSE	[SENSe<1 2>:]DDEMod:SEARch:SYNC:PATTeRn	<string>	not available for R&S ESCI
	FSE	[SENSe<1 2>:]DDEMod:SEARch:SYNC:SElect	<string>	not available for R&S ESCI
	FSE	[SENSe<1 2>:]DDEMod:SEARch:SYNC:STATe	ON OFF	not available for R&S ESCI
	FSE	[SENSe<1 2>:]DDEMod:SEARch:TIME	100 to 1600	not available for R&S ESCI
	FSE	[SENSe<1 2>:]DDEMod:SRATe	160 Hz to 1,6 MHz	not available for R&S ESCI
	FSIQ	[SENSe<1 2>:]DDEMod:SRATe	160 Hz to 7 MHz	not available for R&S ESCI
		[SENSe<1 2>:]DDEMod:TIME	1 to Frame Length	not available for R&S ESCI
	FSET	[SENSe<1 2>:]DEMod	OFF AM AMVideo FM PM	not available for R&S ESCI
	ESIB	[SENSe<1 2>:]DEMod	OFF AM FM	not available for R&S ESCI
	FSET	[SENSe<1 2>:]DEMod:FiLTeR:HPASs:FREQuency	0 Hz 10 Hz 100 Hz 1 kHz	not available for R&S ESCI
	FSET	[SENSe<1 2>:]DEMod:FiLTeR[.LPASs]:AUTo	ON OFF	not available for R&S ESCI
	FSET	[SENSe<1 2>:]DEMod:FiLTeR[.LPASs]:FREQuency	<numeric_value>	not available for R&S ESCI
	FSE	[SENSe<1 2>:]DETeCtoR<1...4>:CMEM[:STATe]	ON OFF	not available for R&S ESCI

Differences in GPIB Behavior between the FSP and the FSE Families of Instruments

Devices		Command (<i>Sheet 35 of 47</i>)	Parameter	Notes
R&S ESCI		[SENSe<1 2>:]DETEctor<1...3>[:FUNctioN]	APEak NEGative POSitive SAMPlE RMS AVERAge QPEak	R&S ESCI: number of traces restricted to 3; detector settings correspond to selected screen FSE: Qpeak not available
	ESIB	[SENSe<1 2>:]DETEctor<1...4>[:FUNctioN]	APEak NEGative POSitive SAMPlE RMS AVERAge QPEak	
R&S ESCI	FSE	[SENSe<1 2>:]DETEctor<1...3>[:FUNctioN]:AUTO	ON OFF	number of traces restricted to 3
	FSET	[SENSe<1 2>:]DETEctor<1...4>:PSTRetch:AUTO	ON OFF	not available for R&S ESCI
	FSET	[SENSe<1 2>:]DETEcto<1...4>:PSTRetch[: STATe]	ON OFF	not available for R&S ESCI
	ESIB	[SENSe<1 2>:]DETEctor<1...4>:RECEiver[: FUNctioN]	POSitive NEGative RMS AVERAge QPEak	not available for R&S ESCI
	FSET	[SENSe<1 2>:]DETEctor<1...4>:RECEiver[: FUNctioN]	POSitive NEGative RMS AVERAge	not available for R&S ESCI
	FSE	[SENSe<1 2>:]FILTEr:CCIT[:STATe]	ON OFF	not available for R&S ESCI and FSET
	FSE	[SENSe<1 2>:]FILTEr:CMESsage[:STATe]	ON OFF	not available for R&S ESCI and FSET
	FSE	[SENSe<1 2>:]FILTEr:DEMPhasis:LINK	DISPlay AUDio	not available for R&S ESCI and FSET
	FSE	[SENSe<1 2>:]FILTEr:DEMPhasis:TCONstant	<numeric_value>	not available for R&S ESCI and FSET
	FSE	[SENSe<1 2>:]FILTEr:DEMPhasis[:STATe]	ON OFF	not available for R&S ESCI and FSET
	FSE	[SENSe<1 2>:]FILTEr:HPASs:FREQuency	30 Hz 300 HZ	not available for R&S ESCI and FSET
	FSET	[SENSe<1 2>:]FILTEr:HPASs:FREQuency	10 kHz 1 kHz 100 Hz	not available for R&S ESCI
	FSE	[SENSe<1 2>:]FILTEr:HPASs[:STATe]	ON OFF	not available for R&S ESCI
	FSE	[SENSe<1 2>:]FILTEr:LPASs:FREQuency	3 kHz 15 kHz	not available for R&S ESCI and FSET
	FSE	[SENSe<1 2>:]FILTEr:LPASs[:STATe]	ON OFF	not available for R&S ESCI and FSET
	FSET	[SENSe<1 2>:]FILTEr:NOTCh[:STATe]	ON OFF	not available for R&S ESCI
	FSET	[SENSe<1 2>:]FM[:DEViatioN]:RANGe:UPPer	ON OFF	not available for R&S ESCI
	FSET	[SENSe<1 2>:]FM[:DEViatioN]:RANGe[:UPPer]	<numeric_value>	not available for R&S ESCI

Differences in GPIB Behavior between the FSP and the FSE Families of Instruments

Devices		Command (<i>Sheet 36 of 47</i>)	Parameter	Notes
R&S ESCI	FSE	[SENSe<1 2>:]FREQuency:CENTer	0 to f_{max}	frequency ranges are different for R&S ESCI and FSE
	FSE	[SENSe<1 2>:]FREQuency:CENTer:LINK	START STOP SPAN	not available for R&S ESCI
R&S ESCI	FSE	[SENSe<1 2>:]FREQuency:CENTer:STEP	0 to f_{max}	frequency ranges are different for R&S ESCI and FSE
R&S ESCI	FSE	[SENSe<1 2>:]FREQuency:CENTer:STEP:LINK	SPAN RBW OFF	
R&S ESCI	FSE	[SENSe<1 2>:]FREQuency:CENTer:STEP:LINK:FACTor	1 to 100 PCT	
R&S ESCI	FSE	[SENSe<1 2>:]FREQuency:MODE	CW FIXed SWEep	
R&S ESCI	FSE	[SENSe<1 2>:]FREQuency:OFFSet	<numeric_value>	
	FSET	[SENSe<1 2>:]FREQuency:RANGe	2 GHz 22 GHz	not available for R&S ESCI
R&S ESCI	FSE	[SENSe<1 2>:]FREQuency:SPAN	0 to f_{max}	frequency ranges are different for R&S ESCI and FSE
R&S ESCI	FSE	[SENSe<1 2>:]FREQuency:SPAN:FULL		
	FSE	[SENSe<1 2>:]FREQuency:SPAN:LINK	CENTer STOP SPAN	not available for R&S ESCI
R&S ESCI	FSE	[SENSe<1 2>:]FREQuency:START	0 to f_{max}	frequency ranges are different for R&S ESCI and FSE
	FSET	[SENSe<1 2>:]FREQuency:START:FLINe[:STATe]	ON OFF	not available for R&S ESCI. Replaced by CALC:MARK:FUNC:SLIMits
	FSE	[SENSe<1 2>:]FREQuency:START:LINK	CENTer STOP SPAN	not available for R&S ESCI
R&S ESCI	FSE	[SENSe<1 2>:]FREQuency:STOP	0 to f_{max}	frequency ranges are different for R&S ESCI and FSE
	FSET	[SENSe<1 2>:]FREQuency:STOP:FLINe[:STATe]	ON OFF	not available for R&S ESCI; replaced by CALC:MARK:FUNC:SLIMits.
	FSE	[SENSe<1 2>:]FREQuency:STOP:LINK	CENTer START SPAN	not available for R&S ESCI
	FSET/ESIB	[SENSe<1 2>:]FREQuency[:CW]:FIXed]	f_{min} to f_{max}	not available for R&S ESCI
	FSET/ESIB	[SENSe<1 2>:]FREQuency[:CW]:FIXed]:STEP	f_{min} to f_{max}	not available for R&S ESCI
R&S ESCI		[SENSe<1 2>:]LIST:POWer:RESult?		new function for R&S ESCI

Differences in GPIB Behavior between the FSP and the FSE Families of Instruments

Devices		Command (<i>Sheet 37 of 47</i>)	Parameter	Notes
R&S ESCI		[SENSe<1 2>:]LIST:POWer[:SEQuence]	<analyzer freq>, <ref level>, <rf att>, <el att>, <filter type>, <rbw>, <vbw>, <meas time>, <trigger level>,...	new function for R&S ESCI
R&S ESCI		[SENSe<1 2>:]LIST:POWer:SET	<PEAK meas>, <RMS meas>, <AVG meas>, <trigger mode>, <trigger slope>, <trigger offset>, <gate length>	new function for R&S ESCI
R&S ESCI		[SENSe<1 2>:]LIST:POWer:STATe	ON OFF	new function for R&S ESCI
	FSE	[SENSe<1 2>:]MIXer:BIAS	<numeric_value>	not available for R&S ESCI
	FSE	[SENSe<1 2>:]MIXer:BIAS:LIMit:MIN	<numeric_value>	not available for R&S ESCI
	FSE	[SENSe<1 2>:]MIXer:BIAS:LIMit[:MAX]	<numeric_value>	not available for R&S ESCI
	FSE	[SENSe<1 2>:]MIXer:BLOCK	ON OFF	not available for R&S ESCI
	FSE	[SENSe<1 2>:]MIXer:HARMonic	<numeric_value>	not available for R&S ESCI
	FSE	[SENSe<1 2>:]MIXer:HARMonic:BAND	A Q U V E W F D G Y J	not available for R&S ESCI
	FSE	[SENSe<1 2>:]MIXer:HARMonic:TYPE	ODD EVEN EODD	not available for R&S ESCI
	FSE	[SENSe<1 2>:]MIXer:LOSS:HIGH	<numeric_value>	not available for R&S ESCI
	FSE	[SENSe<1 2>:]MIXer:LOSS:TABLE	<file_name>	not available for R&S ESCI
	FSE	[SENSe<1 2>:]MIXer:LOSS[:LOW]	<numeric_value>	not available for R&S ESCI
	FSE	[SENSe<1 2>:]MIXer:PORTs	2 3	not available for R&S ESCI
	FSE	[SENSe<1 2>:]MIXer:SIGNal	2 3	not available for R&S ESCI
	FSE	[SENSe<1 2>:]MIXer:THReshold	0.1 to 100 dB	not available for R&S ESCI
	FSE	[SENSe<1 2>:]MIXer[:STATe]	ON OFF	not available for R&S ESCI

Differences in GPIB Behavior between the FSP and the FSE Families of Instruments

Devices		Command (<i>Sheet 38 of 47</i>)	Parameter	Notes
R&S ESCI		[SENSe<1 2>:]MPOWer[:SEQuence]	<analyzer freq>, <rbw>, <meas time>, <trigger source>, <trigger level>, <trigger offset>, <type of meas>, <# of meas>	new function for R&S ESCI
R&S ESCI		[SENSe<1 2>:]MPOWer:RESult[:LIST]?		new function for R&S ESCI
R&S ESCI		[SENSe<1 2>:]MPOWer:RESult:MIN?		new function for R&S ESCI
	FSE	[SENSe<1 2>:]MSUMmary:AHOLd[:STATe]	ON OFF	not available for R&S ESCI and FSET
	FSE	[SENSe<1 2>:]MSUMmary:MODE	ABSolute RELative	not available for R&S ESCI and FSET
	FSE	[SENSe<1 2>:]MSUMmary:MTIME	0.1S 1S	not available for R&S ESCI and FSET
	FSE	[SENSe<1 2>:]MSUMmary:REFerence	<numeric_value>	not available for R&S ESCI and FSET
	FSE	[SENSe<1 2>:]MSUMmary:REFerence:AUTO	ONCE	not available for R&S ESCI and FSET
	FSE	[SENSe<1 2>:]MSUMmary:RUNit	PCT DB	not available for R&S ESCI and FSET
	FSET	[SENSe<1 2>:]PM[:DEViation]:RANGe[:UPPer]	<numeric_value>	not available for R&S ESCI
R&S ESCI	FSE	[SENSe<1 2>:]POWer:ACHannel:ACPairs	0 to 3	R&S ESCI: new parameter value 0 for channel power measurement
R&S ESCI	FSE	[SENSe<1 2>:]POWer:ACHannel: BANDwidth BWIDth:ACHannel	100 to 1000MHz	R&S ESCI: parameter range starts at 100Hz FSE: parameter range starts at 0 Hz
R&S ESCI	FSE	[SENSe<1 2>:]POWer:ACHannel: BANDwidth BWIDth:ALTErnate<1 2>	100 to 1000MHz	R&S ESCI: parameter range starts at 100Hz FSE: parameter range starts at 0 Hz
R&S ESCI	FSE	[SENSe<1 2>:]POWer:ACHannel: BANDwidth BWIDth[:CHANnel]	100 to 1000MHz	R&S ESCI: parameter range starts at 100Hz FSE: parameter range starts at 0 Hz
R&S ESCI	FSE	[SENSe<1 2>:]POWer:ACHannel:MODE	ABSolute RELative	
R&S ESCI	FSE	[SENSe<1 2>:]POWer:ACHannel:PRESet	ACPowEr CPOWEr OBANDwidth OBWidth CN CN0 MCACpower	MCACpower not available for FSE
R&S ESCI		[SENSe<1 2>:]POWer:ACHannel:PRESet:RLEVel		new function for R&S ESCI

Differences in GPIB Behavior between the FSP and the FSE Families of Instruments

Devices		Command (<i>Sheet 39 of 47</i>)	Parameter	Notes
R&S ESCI	FSE	[SENSe<1 2>:]POWer:ACHannel:REFeRence:AUTO	ONCE	
R&S ESCI	FSE	[SENSe<1 2>:]POWer:ACHannel:SPACing[:ACHannel]	100Hz to 2000MHz	different parameter range
R&S ESCI		[SENSe<1 2>:]POWer:CHannel:SPACing:CHANnel	100Hz to 2000MHz	new function for R&S ESCI
	FSE	[SENSe<1 2>:]POWer:ACHannel:SPACing[:UPPer]	0 to 1000MHz	not available for R&S ESCI and FSET
R&S ESCI	FSE	[SENSe<1 2>:]POWer:ACHannel:SPACing:ALTeRnate<1 2>	100Hz to 2000MHz	different parameter range
R&S ESCI		[SENSe<1 2>:]POWer:ACHannel:TXCHannel:COUnT	1 2 3 4	new function for R&S ESCI
R&S ESCI		[SENSe<1 2>:]POWer:ACHannel:REFeRence:TXCHannel:AUTO	MINimum MAXimum LHIGhest	new function for R&S ESCI
R&S ESCI		[SENSe<1 2>:]POWer:ACHannel:REFeRence:TXCHannel:MANual	1 to 12	new function for R&S ESCI
R&S ESCI	FSE	[SENSe<1 2>:]POWer:BANDwidth BWiDth	10 to 99.9PCT	different parameter range
R&S ESCI		[SENSe<1 2>:]POWer:HSPeed	ON OFF	new function for R&S ESCI
R&S ESCI		[SENSe<1 2>:]POWer:NCORrection	ON OFF	new function for R&S ESCI
R&S ESCI		[SENSe<1 2>:]POWer:TRACe	1 to 3	new function for R&S ESCI
R&S ESCI	FSE	[SENSe<1 2>:]ROSCillator:[INTeRnal:]TUNe	0 to 4095	
R&S ESCI	FSE	[SENSe<1 2>:]ROSCillator:[INTeRnal:]TUNe:SAVe		
	FSE	[SENSe<1 2>:]ROSCillator:EXTeRnal:FREQUency	1MHz to 16MHz	not available for R&S ESCI
R&S ESCI	FSE	[SENSe<1 2>:]ROSCillator:SOURce	INTeRnal EXTeRnal	
	FSET/ESIB	[SENSe<1 2>:]SCAN<1...10>:RANGes[COUnT]	1 to 10	not available for R&S ESCI
	FSE/ESIB	[SENSe<1 2>:]SCAN<1...10>:BANDwidth:RESolution	f_{min} to f_{max}	not available for R&S ESCI
	FSET/ESIB	[SENSe<1 2>:]SCAN<1...10>:INPut:ATTenuation	dB_{min} to dB_{max}	not available for R&S ESCI
	FSET/ESIB	[SENSe<1 2>:]SCAN<1...10>:INPut:ATTenuation:AUTO	ON OFF	not available for R&S ESCI
	FSET	[SENSe<1 2>:]SCAN<1...10>:INPut:BIMPedance	150OHM 600OHM 10kOHM	not available for R&S ESCI
	FSET	[SENSe<1 2>:]SCAN<1...10>:INPut:GAIN	0dB to 30dB	not available for R&S ESCI
	FSET/ESIB	[SENSe<1 2>:]SCAN<1...10>:INPut:GAIN:AUTO	ON OFF	not available for R&S ESCI

Differences in GPIB Behavior between the FSP and the FSE Families of Instruments

Devices		Command (<i>Sheet 40 of 47</i>)	Parameter	Notes
	ESIB	[SENSe<1 2>:]SCAN<1...10>:INPut:GAIN[:STATE]	ON OFF	not available for R&S ESCI
	ESIB	[SENSe<1 2>:]SCAN<1...10>:INPut:TYPE	INPUT1 INPUT2	not available for R&S ESCI
	FSET	[SENSe<1 2>:]SCAN<1...10>:INPut:TYPE	RF BALanced	not available for R&S ESCI
	FSET/ ESIB	[SENSe<1 2>:]SCAN<1...10>:STARt	f_{min} to f_{max}	not available for R&S ESCI
	FSET/ ESIB	[SENSe<1 2>:]SCAN<1...10>:STEP	f_{min} to f_{max}	not available for R&S ESCI
	FSET/ ESIB	[SENSe<1 2>:]SCAN<1...10>:STOP	f_{min} to f_{max}	not available for R&S ESCI
	FSET/ ESIB	[SENSe<1 2>:]SCAN<1...10>:TIME	100 μ s to 100 s	not available for R&S ESCI
R&S ESCI	FSE	[SENSe<1 2>:]SWEep:COUNT	0 to 32767	
R&S ESCI	FSE	[SENSe<1 2>:]SWEep:EGATe	ON OFF	
R&S ESCI	FSE	[SENSe<1 2>:]SWEep:EGATe:HOLDoff	0 to 100s	
R&S ESCI	FSE	[SENSe<1 2>:]SWEep:EGATe:LENGth	0 to 100s	
	FSE	[SENSe<1 2>:]SWEep:EGATe:LENGth	0 to 100s	
	FSE	[SENSe<1 2>:]SWEep:EGATe:LEVel	-5V to +5V	not available for R&S ESCI
R&S ESCI	FSE	[SENSe<1 2>:]SWEep:EGATe:POLarity	POSitive NEGative	
R&S ESCI	FSE	[SENSe<1 2>:]SWEep:EGATe:SOURce	EXTernal IFPower RFPower	
R&S ESCI	FSE	[SENSe<1 2>:]SWEep:EGATe:TYPE	LEVel EDGE	
	FSE	[SENSe<1 2>:]SWEep:GAP	ON OFF	not available for R&S ESCI
	FSE	[SENSe<1 2>:]SWEep:GAP:LENGth	0 to 100s	not available for R&S ESCI
	FSE	[SENSe<1 2>:]SWEep:GAP:PRETrigger	0 to 100s	not available for R&S ESCI
	FSE	[SENSe<1 2>:]SWEep:GAP:TRGTogap	0 to 100s	not available for R&S ESCI
R&S ESCI		[SENSe<1 2>:]SWEep:POINts	<numeric_value>	not available for FSE
	FSET/ ESIB	[SENSe<1 2>:]SWEep:SPACing	LINear LOGarithmic AUTO	not available for R&S ESCI
	FSE/ FSIQ	[SENSe<1 2>:]SWEep:SPACing	LINear LOGarithmic	not available for R&S ESCI

Differences in GPIB Behavior between the FSP and the FSE Families of Instruments

Devices		Command (<i>Sheet 41 of 47</i>)	Parameter	Notes
R&S ESCI	FSE	[SENSe<1 2>:]SWEp:TIME	2.5ms to 1000s 1µs to 16000s	different parameter ranges for R&S ESCI and FSE
R&S ESCI	FSE	[SENSe<1 2>:]SWEp:TIME:AUTO	ON OFF	
	FSE	[SENSe<1 2>:]TCAPture:LENGth	1024 2048 4096 8192 16384	not available for R&S ESCI
	FSE	[SENSe<1 2>:]TV:PSOffset	0 to 6.5 MHz	not available for R&S ESCI and FSET
R&S ESCI		[SENSe<1 2>:]TV:CCVS	INternal EXternal	new function for R&S ESCI
R&S ESCI	FSE	[SENSe<1 2>:]TV[::STATe]	ON OFF	
R&S ESCI	FSE	SOURce:AM:STATe	ON OFF	
R&S ESCI	FSE	SOURce:DM:STATe	ON OFF	
R&S ESCI		SOURce:EXternal[::STATe]	ON OFF	new command for R&S ESCI
R&S ESCI		SOURce:EXternal:FREQuency:OFFset	<numeric_value>	new command for R&S ESCI
R&S ESCI		SOURce:EXternal:FREQuency[::FACTor]:NUMerator	<numeric_value>	new command for R&S ESCI
R&S ESCI		SOURce:EXternal:FREQuency[::FACTor]:DENominator	<numeric_value>	new command for R&S ESCI
R&S ESCI		SOURce:EXternal:FREQuency:SWEp[::STATe]	ON OFF	new command for R&S ESCI
R&S ESCI		SOURce:EXternal:POWER[::LEVel]	<numeric_value>	new command for R&S ESCI
R&S ESCI	FSE	SOURce:FM:STATe	ON OFF	
R&S ESCI	FSE	SOURce:FREQuency:OFFSet	-150Hz to 150MHz	different value ranges for R&S ESCI and FSE
	FSE	SOURce:POWER:ALC:SOURce	INternal EXternal	not available for R&S ESCI and FSET
R&S ESCI	FSE	SOURce:POWER[::LEVel][::IMMediate]:OFFSet	-200dB to +200dB	
R&S ESCI	FSE	SOURce:POWER[::LEVel][::IMMediate][::AMPLitude]	-30dBm to 0dBm	different value ranges for R&S ESCI and FSE
R&S ESCI	FSE	STATus:OPERation:CONDition?		
	FSE	STATus:OPERation:CONDition?		
R&S ESCI	FSE	STATus:OPERation:ENABLE	0 to 65535	
R&S ESCI	FSE	STATus:OPERation:NTRansition	0 to 65535	

Differences in GPIB Behavior between the FSP and the FSE Families of Instruments

Devices		Command (<i>Sheet 42 of 47</i>)	Parameter	Notes
R&S ESCI	FSE	STATus:OPERation:PTRansition	0 to 65535	
R&S ESCI	FSE	STATus:OPERation[:EVENT?]		
R&S ESCI	FSE	STATus:PRESet		
R&S ESCI	FSE	STATus:QUEStionable:ACPLimit:CONDition?		
R&S ESCI	FSE	STATus:QUEStionable:ACPLimit:ENABle	0 to 65535	
R&S ESCI	FSE	STATus:QUEStionable:ACPLimit:NTRansition	0 to 65535	
R&S ESCI	FSE	STATus:QUEStionable:ACPLimit:PTRansition	0 to 65535	
R&S ESCI	FSE	STATus:QUEStionable:ACPLimit[:EVENT?]		
R&S ESCI	FSE	STATus:QUEStionable:CONDition?		
R&S ESCI	FSE	STATus:QUEStionable:ENABle	0 to 65535	
R&S ESCI	FSE	STATus:QUEStionable:FREQuency:CONDition?		
R&S ESCI	FSE	STATus:QUEStionable:FREQuency:ENABle	0 to 65535	
R&S ESCI	FSE	STATus:QUEStionable:FREQuency:NTRansition	0 to 65535	
R&S ESCI	FSE	STATus:QUEStionable:FREQuency:PTRansition	0 to 65535	
R&S ESCI	FSE	STATus:QUEStionable:FREQuency[:EVENT?]		
R&S ESCI	FSE	STATus:QUEStionable:LIMit<1 2>:CONDition?		R&S ESCI: individual registers for screen A and B
R&S ESCI	FSE	STATus:QUEStionable:LIMit<1 2>:ENABle	0 to 65535	R&S ESCI: individual registers for screen A and B
R&S ESCI	FSE	STATus:QUEStionable:LIMit<1 2>:NTRansition	0 to 65535	R&S ESCI: individual registers for screen A and B
R&S ESCI	FSE	STATus:QUEStionable:LIMit<1 2>:PTRansition	0 to 65535	R&S ESCI: individual registers for screen A and B
R&S ESCI	FSE	STATus:QUEStionable:LIMit<1 2>[:EVENT?]		R&S ESCI: individual registers for screen A and B
R&S ESCI	FSE	STATus:QUEStionable:LMARgin<1 2>:CONDition?		R&S ESCI: individual registers for screen A and B

Differences in GPIB Behavior between the FSP and the FSE Families of Instruments

Devices		Command (<i>Sheet 43 of 47</i>)	Parameter	Notes
R&S ESCI	FSE	STATus:QUEStionable:LMARgin<1 2>:ENABLE	0 to 65535	R&S ESCI: individual registers for screen A and B
R&S ESCI	FSE	STATus:QUEStionable:LMARgin<1 2>:NTRansition	0 to 65535	R&S ESCI: individual registers for screen A and B
R&S ESCI	FSE	STATus:QUEStionable:LMARgin<1 2>:PTRansition	0 to 65535	R&S ESCI: individual registers for screen A and B
R&S ESCI	FSE	STATus:QUEStionable:LMARgin<1 2>[:EVENT]?		R&S ESCI: individual registers for screen A and B
R&S ESCI	FSE	STATus:QUEStionable:NTRansition	0 to 65535	
R&S ESCI	FSE	STATus:QUEStionable:POWer:CONDition?		
R&S ESCI	FSE	STATus:QUEStionable:POWer:ENABLE	0 to 65535	
R&S ESCI	FSE	STATus:QUEStionable:POWer:NTRansition	0 to 65535	
R&S ESCI	FSE	STATus:QUEStionable:POWer:PTRansition	0 to 65535	
R&S ESCI	FSE	STATus:QUEStionable:POWer[:EVENT]?		
R&S ESCI	FSE	STATus:QUEStionable:PTRansition	0 to 65535	
R&S ESCI	FSE	STATus:QUEStionable:SYNC:CONDition?		
R&S ESCI	FSE	STATus:QUEStionable:SYNC:ENABLE	0 to 65535	
R&S ESCI	FSE	STATus:QUEStionable:SYNC:NTRansition	0 to 65535	
R&S ESCI	FSE	STATus:QUEStionable:SYNC:PTRansition	0 to 65535	
R&S ESCI	FSE	STATus:QUEStionable:SYNC[:EVENT]?		
	FSE	STATus:QUEStionable:TRANsdncer:CONDition?		not available for R&S ESCI
	FSE	STATus:QUEStionable:TRANsdncer:ENABLE	0 to 65535	not available for R&S ESCI
	FSE	STATus:QUEStionable:TRANsdncer:NTRansition	0 to 65535	not available for R&S ESCI
	FSE	STATus:QUEStionable:TRANsdncer:PTRansition	0 to 65535	not available for R&S ESCI
	FSE	STATus:QUEStionable:TRANsdncer[:EVENT]?		not available for R&S ESCI
R&S ESCI	FSE	STATus:QUEStionable[:EVENT]?		

Differences in GPIB Behavior between the FSP and the FSE Families of Instruments

Devices		Command (<i>Sheet 44 of 47</i>)	Parameter	Notes
R&S ESCI	FSE	STATus:QUEue[:NEXT?]		
	FSE	SYSTem:BINFo?		not available for R&S ESCI
R&S ESCI		SYSTem:COMMunicate:GPIB:RDEvice:GENerator<1 2>:ADDRess	0 to 30	new command for R&S ESCI
	FSE	SYSTem:COMMunicate:GPIB:RDEvice<1 2>:ADDRess	0 to 30	not available for R&S ESCI
R&S ESCI	FSE	SYSTem:COMMunicate:GPIB[:SELF]:ADDRess	0 to 30	
R&S ESCI	FSE	SYSTem:COMMunicate:GPIB[:SELF]:RTERminator	LFEOI EOI	
R&S ESCI	FSE	SYSTem:COMMunicate:PRINter:ENUMerate:FIRSt?		
R&S ESCI	FSE	SYSTem:COMMunicate:PRINter:ENUMerate:NEXT?		
R&S ESCI		SYSTem:COMMunicate:PRINter:SElect<1 2>	<printer_name>	numeric suffix behind SElect
	FSIQ/ESIB	SYSTem:COMMunicate:PRINter<1 2>:SElect	<printer_name>	numeric suffix behind PRINters
R&S ESCI		SYSTem:COMMunicate:RDEvice:GENerator<1 2>:LINK	GPIB TTL	new function for R&S ESCI
R&S ESCI		SYSTem:COMMunicate:RDEvice:GENerator<1 2>:TYPE	<name>	new function for R&S ESCI
R&S ESCI	FSE	SYSTem:COMMunicate:SERial:CONTRol:DTR	IBFull OFF	only SERial1 available for R&S ESCI
R&S ESCI	FSE	SYSTem:COMMunicate:SERial:CONTRol:RTS	IBFull OFF	only SERial1 available for R&S ESCI
R&S ESCI	FSE	SYSTem:COMMunicate:SERial[:RECeive]:BAUD	110 300 600 1200 2400 9600 19200 38400 57600 115200 128000	only SERial1 available for R&S ESCI
R&S ESCI	FSE	SYSTem:COMMunicate:SERial[:RECeive]:BITS	7 8	only SERial1 available for R&S ESCI
R&S ESCI	FSE	SYSTem:COMMunicate:SERial[:RECeive]:PACE	XON NONE	only SERial1 available for R&S ESCI
R&S ESCI	FSE	SYSTem:COMMunicate:SERial[:RECeive]:PARity[:TYPE]	EVEN ODD NONE	only SERial1 available for R&S ESCI
R&S ESCI	FSE	SYSTem:COMMunicate:SERial[:RECeive]:SBITS	1 2	only SERial1 available for R&S ESCI
R&S ESCI	FSE	SYSTem:DATE	1980 to 2099, 1 to 12, 1 to 31	
R&S ESCI		SYSTem:DISPlay:FPANel	ON OFF	new function for R&S ESCI
R&S ESCI	FSE	SYSTem:DISPlay:UPDate	ON OFF	

Differences in GPIB Behavior between the FSP and the FSE Families of Instruments

Devices		Command (<i>Sheet 45 of 47</i>)	Parameter	Notes
R&S ESCI	FSE	SYSTem:ERRor[:NEXT]?		new function for R&S ESCI, but compatible to SYSTem:ERRor? on the FSE
R&S ESCI		SYSTem:ERRor:LIST?		new function for R&S ESCI
R&S ESCI		SYSTem:ERRor:CLEar:ALL		new command for R&S ESCI
R&S ESCI	FSE	SYSTem:FIRMware:UPDate	<path>	
R&S ESCI		SYSTem:LANGuage	'SCPI' '8560E' '8561E' '8562E' '8563E' '8564E' '8565E' '8566A' '8566B' '8568A' '8568B' '8594E'	new command for R&S ESCI
R&S ESCI	FSE	SYSTem:PASSword[:CENable]	'pass word'	
R&S ESCI	FSE	SYSTem:PRESet		
	ESIB/ FSIQ	SYSTem:PRESet:COMPAtible	FSE OFF	not available for R&S ESCI
R&S ESCI	FSE	SYSTem:SET		
R&S ESCI	FSE	SYSTem:SPEaker:VOLume	0 to 1	
R&S ESCI	FSE	SYSTem:TIME	0 to 23, 0 to 59, 0 to 59	
R&S ESCI	FSE	SYSTem:VERSion?		
R&S ESCI	FSE	TRACe:COPI	TRACE1 TRACE2 TRACE3 , TRACE1 TRACE2 TRACE3	only TRACE1...TRACE3 available for R&S ESCI
	FSET/ ESIB	TRACe:FEED:CONTRol<1...4>	ALWays NEVer	not available for R&S ESCI
R&S ESCI	FSE	TRACe[:DATA]	TRACE1 TRACE2 TRACE3 , <block> <numeric_value>	only TRACE1...TRACE3 available for R&S ESCI
	FSET/ ESIB	TRACe[:DATA]	TRACE1 TRACE2 TRACE3 TRACE4 SINGle SCAN STATus, <block> <numeric_value>	
R&S ESCI		TRACe:IQ:DATA?		new function for R&S ESCI

Differences in GPIB Behavior between the FSP and the FSE Families of Instruments

Devices		Command (Sheet 46 of 47)	Parameter	Notes
R&S ESCI		TRACe:IQ:SET	<filter type>, <rbw>, <sample rate>, <trigger source>, <trigger slope>, <pretrigger samples>, <# of samples>	new function for R&S ESCI
R&S ESCI		TRACe:IQ:AVERAge[:STATe]	ON OFF	new function for R&S ESCI
R&S ESCI		TRACe:IQ:AVERAge:COUNT	<numeric_value>	new function for R&S ESCI
R&S ESCI		TRACe:IQ:SRATe	16kHz to 32MHz	new function for R&S ESCI
R&S ESCI		TRACe:IQ[:STATe]	ON OFF	new function for R&S ESCI
R&S ESCI	FSE	TRIGger<1 2>[:SEQuence]:HOLDoff	0 to 100s	
	FSE	TRIGger<1 2>[:SEQuence]:LEVel:AF	-120 to +120PCT	not available for R&S ESCI
	FSE	TRIGger<1 2>[:SEQuence]:LEVel:VIDeo	0 to 100PCT	not available for R&S ESCI; replaced by TRIGger:SEQuence: SOURce:VIDeo
	FSE	TRIGger<1 2>[:SEQuence]:LEVel[:EXTernal]	-5.0 to +5.0V	not available for R&S ESCI
R&S ESCI		TRIGger<1 2>[:SEQuence]:LEVel:IFPower	<numeric_value>	new command for R&S ESCI
R&S ESCI	FSE	TRIGger<1 2>[:SEQuence]:SLOPe	POSitive NEGative	
R&S ESCI		TRIGger<1 2>[:SEQuence]:SOURce	IMMediate LINE EXTernal VIDeo IFPower	
	FSE/ ESIB	TRIGger<1 2>[:SEQuence]:SOURce	IMMediate LINE EXTernal VIDeo RFPower TV AF	
	FSIQ	TRIGger<1 2>[:SEQuence]:SOURce	IMMediate LINE EXTernal VIDeo RFPower AF	
	FSET	TRIGger<1 2>[:SEQuence]:SOURce	IMMediate LINE EXTernal VIDeo	
R&S ESCI	FSE	TRIGger<1 2>[:SEQuence]:SOURce:VIDeo: FORMat:LPFrame	525 625	requires option B6 on FSP
R&S ESCI	FSE	TRIGger<1 2>[:SEQuence]:SOURce:VIDeo: FIEld:SElect	ALL ODD EVEN	requires option B6 on FSP
R&S ESCI	FSE	TRIGger<1 2>[:SEQuence]:SOURce:VIDeo:LINE: NUMBer	<numeric_value>	requires option B6 on FSP
R&S ESCI	FSE	TRIGger<1 2>[:SEQuence]:SOURce:VIDeo: SSIGnal:POLarity	NEGative POSitive	requires option B6 on FSP

Differences in GPIB Behavior between the FSP and the FSE Families of Instruments

Devices		Command (<i>Sheet 47 of 47</i>)	Parameter	Notes
	FSE/ ESIB	TRIGger<1 2>[:SEQuence]:SYNChronize:ADJust: FRAMe	0 to 100s	not available for R&S ESCI
	FSE	TRIGger<1 2>[:SEQuence]:SYNChronize:ADJust: FRAMe:AUTO	ONCE	not available for R&S ESCI and FSET
	FSE	TRIGger<1 2>[:SEQuence]:SYNChronize:ADJust: SLOT	0 to 100s	not available for R&S ESCI and FSET
	FSE	TRIGger<1 2>[:SEQuence]:SYNChronize:ADJust: SLOT:AUTO	ONCE	not available for R&S ESCI and FSET
	FSE	TRIGger<1 2>[:SEQuence]:SYNChronize: SOURce	FRAMe TSC	not available for R&S ESCI and FSET
R&S ESCI		UNIT<1 2>:POWer	DBM DBPW WATT DBUV DBMV VOLT DBUA AMP V A W	available units are compatible to the FSE.
	FSE/ FSIQ	UNIT<1 2>:POWer	DBM DBPW WATT DBUV DBMV VOLT DBUA AMP DB PCT UNITLESS DBUV_MHZ DBMV_MHZ DBUA_MHZ DBUV_M DBIA_M DBUV_MMHZ DBUA_MMHZ	for R&S ESCI, the following units apply: DBM DBPW WATT DBUV DBMV VOLT DBUA AMP V A W
	FSET/ ESIB	UNIT<1 2>:POWer	DBM DBPW DBPT WATT DBUV DBMV VOLT DBUA AMPere V W DB PCT UNITLESS DBUV_MHZ DBMV_MHZ DBUA_MHZ DBUV_M DBIA_M DBUV_MMHZ DBUA_MMHZ	for R&S ESCI, the following units apply: DBM DBPW WATT DBUV DBMV VOLT DBUA AMP V A W
	FSE	UNIT<1 2>:PROBe	ON OFF	not available for R&S ESCI

6.25 Alphabetical List of Remote Commands

Command	Parameter	Page
	DISPlay[:WINDow<1 2>]:TRACe<1...3>: Y[:SCALe]:RVALue	6.109
		6.89
*CAL?		6.8
*CLS		6.8
*ESE 0 to 255		6.8
*ESR?		6.8
*IDN?		6.9
*IST?		6.9
*OPC		6.9
*OPC?		6.9
*OPT?		6.9
*PCB 0 to 30		6.9
*PRE 0 to 255		6.10
*PSC 0 1		6.10
*RST		6.10
*SRE 0 to 255		6.10
*STB?		6.10
*TRG		6.10
*TST?		6.10
*WAI		6.10
:CALCulate<1 2>:ESpectrum:PSEarch PEAKsearch:MARGin	-200dB ... +200dB	6.21
ABORt		6.11
CALCulate:STATistics:APD[:STATe]	ON OFF	6.91
CALCulate:STATistics:CCDF[:STATe]	ON OFF	6.91
CALCulate:STATistics:CCDF:X<1...3>?	P0_01 P0_1 P1 P10	6.91
CALCulate:STATistics:NSAMples	100 to 1E9	6.92
CALCulate:STATistics:PRESet		6.94
CALCulate:STATistics:RESult<1...3>?	MEAN PEAK CFACtor ALL	6.94
CALCulate:STATistics:SCALe:AUTO	ONCE	6.92
CALCulate:STATistics:SCALe:X:RANGe	1dB to 200dB	6.93
CALCulate:STATistics:SCALe:X:RLEVel	-130dBm to 30dBm	6.92
CALCulate:STATistics:SCALe:Y:LOWer	1E-9 to 0.1	6.93
CALCulate:STATistics:SCALe:Y:UNIT	PCT ABS	6.93
CALCulate:STATistics:SCALe:Y:UPPer	1E-8 to 1.0	6.93
CALCulate<1 2>:DELTamarker<1...4>:AOFF		6.13
CALCulate<1 2>:DELTamarker<1...4>:FUNctioN:FIXed:RPOint: MAXimum[:PEAK]	<numeric_value>	6.18
CALCulate<1 2>:DELTamarker<1...4>:FUNctioN:FIXed:RPOint:X	<numeric_value>	6.19
CALCulate<1 2>:DELTamarker<1...4>:FUNctioN:FIXed:RPOint:Y	<numeric_value>	6.18
CALCulate<1 2>:DELTamarker<1...4>:FUNctioN:FIXed:RPOint:Y:OFFSet	<numeric_value>	6.18
CALCulate<1 2>:DELTamarker<1...4>:FUNctioN:FIXed[:STATe]	ON OFF	6.17
CALCulate<1 2>:DELTamarker<1...4>:FUNctioN:PNOise:AUTO	ON OFF	6.19
CALCulate<1 2>:DELTamarker<1...4>:FUNctioN:PNOise:RESult?		6.20
CALCulate<1 2>:DELTamarker<1...4>:FUNctioN:PNOise[:STATe]	ON OFF	6.19
CALCulate<1 2>:DELTamarker<1...4>:LINK	ON OFF	6.17
CALCulate<1 2>:DELTamarker<1...4>:MAXimum:LEFT		6.16
CALCulate<1 2>:DELTamarker<1...4>:MAXimum:NEXT		6.15
CALCulate<1 2>:DELTamarker<1...4>:MAXimum[:PEAK]		6.15
CALCulate<1 2>:DELTamarker<1...4>:MAXimum:RIGHT		6.16
CALCulate<1 2>:DELTamarker<1...4>:MINimum:LEFT		6.17
CALCulate<1 2>:DELTamarker<1...4>:MINimum:NEXT		6.16
CALCulate<1 2>:DELTamarker<1...4>:MINimum[:PEAK]		6.16

Alphabetical List of Remote Commands

Command	Parameter	Page
CALCulate<1 2>:DELTamarker<1...4>:MINimum:RIGHT		6.17
CALCulate<1 2>:DELTamarker<1...4>:MODE	ABSolute RELative	6.13
CALCulate<1 2>:DELTamarker<1...4>[:STATe]	ON OFF	6.13
CALCulate<1 2>:DELTamarker<1...4>:TRACe	1 to 3	6.14
CALCulate<1 2>:DELTamarker<1...4>:X	0 to MAX (frequency sweep time)	6.14
CALCulate<1 2>:DELTamarker<1...4>:X:RELative?		6.14
CALCulate<1 2>:DELTamarker<1...4>:Y?		6.15
CALCulate<1 2>:DLINe<1 2>	MINimum .. MAXimum (depending on current unit)	6.95
CALCulate<1 2>:DLINe<1 2>:STATe	ON OFF	6.95
CALCulate<1 2>:ESpectrum:PSEArch PEAKsearch:AUTO	ON OFF	6.21
CALCulate<1 2>:FLINe<1 2>	0 to fmax	6.96
CALCulate<1 2>:FLINe<1 2>:STATe	ON OFF	6.96
CALCulate<1 2>:LIMit<1...8>:ACPower:ACHannel:ABSolute	-200DBM to 200DBM, -200 to 200DBM	6.28
CALCulate<1 2>:LIMit<1...8>:ACPower:ACHannel:ABSolute:STATe	ON OFF	6.29
CALCulate<1 2>:LIMit<1...8>:ACPower:ACHannel[:RELative]	0 to 100dB, 0 to 100dB	6.27
CALCulate<1 2>:LIMit<1...8>:ACPower:ACHannel[:RELative]:STATe	ON OFF	6.27
CALCulate<1 2>:LIMit<1...8>:ACPower:ACHannel:RESult?		6.29
CALCulate<1 2>:LIMit<1...8>:ACPower:ALternate<1 to 11>:ABSolute	-200DBM to 200DBM, -200DBM to 200DBM	6.31
CALCulate<1 2>:LIMit<1...8>:ACPower:ALternate<1 to 11>:ABSolute:STATe	ON OFF	6.32
CALCulate<1 2>:LIMit<1...8>:ACPower:ALternate<1 to 11>[:RELative]	0 to 100dB, 0 to 100dB.	6.30
CALCulate<1 2>:LIMit<1...8>:ACPower:ALternate<1 to 11>[:RELative]:STATe	ON OFF	6.30
CALCulate<1 2>:LIMit<1...8>:ACPower:ALternate<1 to 11>:RESult?		6.32
CALCulate<1 2>:LIMit<1...8>:ACPower[:STATe]	ON OFF	6.27
CALCulate<1 2>:LIMit<1...8>:ACTive?		6.23
CALCulate<1 2>:LIMit<1...8>:CATalog?		6.23
CALCulate<1 2>:LIMit<1...8>:CLEAr[:IMMediate]		6.25
CALCulate<1 2>:LIMit<1...8>:COMMeNt	<string>	6.25
CALCulate<1 2>:LIMit<1...8>:CONTRol[:DATA]	<numeric_value>,<numeric_value>..	6.34
CALCulate<1 2>:LIMit<1...8>:CONTRol:DOMain	FREQuency TIME	6.34
CALCulate<1 2>:LIMit<1...8>:CONTRol:MODE	RELative ABSolute	6.35
CALCulate<1 2>:LIMit<1...8>:CONTRol:OFFSet	<numeric_value>	6.34
CALCulate<1 2>:LIMit<1...8>:CONTRol:SHIFt	<numeric_value>	6.35
CALCulate<1 2>:LIMit<1...8>:CONTRol:SPACing	LINear LOGarithmic	6.35
CALCulate<1 2>:LIMit<1...8>:COPY	1 to 8 <name>	6.25
CALCulate<1 2>:LIMit<1...8>:DELete		6.26
CALCulate<1 2>:LIMit<1...8>:FAIL?		6.24
CALCulate<1 2>:LIMit<1...8>:LOWer[:DATA]	<numeric_value>,<numeric_value>...	6.36
CALCulate<1 2>:LIMit<1...8>:LOWer:MARGIn	<numeric_value>	6.37
CALCulate<1 2>:LIMit<1...8>:LOWer:MODE	RELative ABSolute	6.37
CALCulate<1 2>:LIMit<1...8>:LOWer:OFFSet	<numeric_value>	6.37
CALCulate<1 2>:LIMit<1...8>:LOWer:SHIFt	<numeric_value>	6.37
CALCulate<1 2>:LIMit<1...8>:LOWer:SPACing	LINear LOGarithmic	6.38
CALCulate<1 2>:LIMit<1...8>:LOWer:STATe	ON OFF	6.36
CALCulate<1 2>:LIMit<1...8>:LOWer:THReshold	<numeric_value>	6.38
CALCulate<1 2>:LIMit<1...8>:NAME	<name of limit line>	6.26
CALCulate<1 2>:LIMit<1...8>:STATe	ON OFF	6.24
CALCulate<1 2>:LIMit<1...8>:TRACe	1 to 3	6.23
CALCulate<1 2>:LIMit<1...8>:UNIT	AMPere DB DBM DBMV DBPT DBPW DBUA DBUA_M DBUV DBUV_M DBV DEG HZ PCT RAD S UNITLESS VOLT WATT	6.24
CALCulate<1 2>:LIMit<1...8>:UPPer[:DATA]	<numeric_value>,<numeric_value>...	6.39

Alphabetical List of Remote Commands

Command	Parameter	Page
CALCulate<1 2>:LIMit<1...8>:UPPer:MARGin	<numeric_value>	6.40
CALCulate<1 2>:LIMit<1...8>:UPPer:MODE	RELative ABSolute	6.40
CALCulate<1 2>:LIMit<1...8>:UPPer:OFFSet	<numeric_value>	6.40
CALCulate<1 2>:LIMit<1...8>:UPPer:SHIFt	<numeric_value>	6.40
CALCulate<1 2>:LIMit<1...8>:UPPer:SPACing	LINear LOGarithmic	6.41
CALCulate<1 2>:LIMit<1...8>:UPPer:STATe	ON OFF	6.39
CALCulate<1 2>:LIMit<1...8>:UPPer:THReshold	<numeric_value>	6.41
CALCulate<1 2>:MARKer<1 to 4>:FUNCTion:POWer:PRESet	NADC TETRA PDC PHS CDPD FWCDma RWCDma F8CDma R8CDma F19Cdma R19Cdma FW3Gppcdma RW3Gppcdma D2CDma S2CDma M2CDma FIS95A FIS95A FIS95C0 FIS95C0 FJ008 RJ008 FIS95C1 FIS95C1 TCDMA NONE AWLan BWLan WIMax WIBro EUTRa REUTra 'string'	6.71
CALCulate<1 2>:MARKer<1 to 4>:FUNCTion:POWer:STANdard:SAVE	<file_name>	6.71
CALCulate<1 2>:MARKer<1 to 4>:FUNCTion:TOI:MARKer	CALCulate SEARCh	6.59
CALCulate<1 2>:MARKer<1...4>:AOFF		6.42
CALCulate<1 2>:MARKer<1...4>:COUNT	ON OFF	6.44
CALCulate<1 2>:MARKer<1...4>:COUNT:FREQUency?		6.45
CALCulate<1 2>:MARKer<1...4>:COUNT:RESolution	0.1 1 10 100 1000 10000 Hz	6.45
CALCulate<1 2>:MARKer<1...4>:COUPLed[:STATe]	ON OFF	6.45
CALCulate<1 2>:MARKer<1...4>:FUNCTion:CENTer		6.60
CALCulate<1 2>:MARKer<1...4>:FUNCTion:CSTep		6.60
CALCulate<1 2>:MARKer<1...4>:FUNCTion:DEModulation:CONTinuous	ON OFF	6.57
CALCulate<1 2>:MARKer<1...4>:FUNCTion:DEModulation:HOLDoff	10ms to 1000s	6.57
CALCulate<1 2>:MARKer<1...4>:FUNCTion:DEModulation:SElect	AM FM	6.56
CALCulate<1 2>:MARKer<1...4>:FUNCTion:DEModulation:SQUelch:LEVel	0 to 100 PCT	6.57
CALCulate<1 2>:MARKer<1...4>:FUNCTion:DEModulation:SQUelch[:STATe]	ON OFF	6.57
CALCulate<1 2>:MARKer<1...4>:FUNCTion:DEModulation[:STATe]	ON OFF	6.56
CALCulate<1 2>:MARKer<1...4>:FUNCTion:FPEaks:COUNT?		6.51
CALCulate<1 2>:MARKer<1...4>:FUNCTion:FPEaks[:IMMEDIATE]	<numeric_value>	6.51
CALCulate<1 2>:MARKer<1...4>:FUNCTion:FPEaks:SORT	X Y	6.53
CALCulate<1 2>:MARKer<1...4>:FUNCTion:FPEaks:X?		6.52
CALCulate<1 2>:MARKer<1...4>:FUNCTion:FPEaks:Y?		6.52
CALCulate<1 2>:MARKer<1...4>:FUNCTion:HARMonics:BANDwidth:AUTO	ON OFF	6.61
CALCulate<1 2>:MARKer<1...4>:FUNCTion:HARMonics:BANDwidth[:LIST]?		6.61
CALCulate<1 2>:MARKer<1...4>:FUNCTion:HARMonics:DISTortion? TOTal		6.62
CALCulate<1 2>:MARKer<1...4>:FUNCTion:HARMonics:LIST?		6.63
CALCulate<1 2>:MARKer<1...4>:FUNCTion:HARMonics:NHARMonics	1 to 26	6.61
CALCulate<1 2>:MARKer<1...4>:FUNCTion:HARMonics:PRESet		6.62
CALCulate<1 2>:MARKer<1...4>:FUNCTion:HARMonics[:STATe]	ON OFF	6.61
CALCulate<1 2>:MARKer<1...4>:FUNCTion:MDEPth:RESult?		6.58
CALCulate<1 2>:MARKer<1...4>:FUNCTion:MDEPth[:STATe]		6.57
CALCulate<1 2>:MARKer<1...4>:FUNCTion:MSUMmary?	<time offset of first pulse>, <measurement time>, <period>, <# of pulses to measure>	6.85
CALCulate<1 2>:MARKer<1...4>:FUNCTion:NDBDown	<numeric_value>	6.53
CALCulate<1 2>:MARKer<1...4>:FUNCTion:NDBDown:FREQUency?		6.54
CALCulate<1 2>:MARKer<1...4>:FUNCTion:NDBDown:RESult?		6.53
CALCulate<1 2>:MARKer<1...4>:FUNCTion:NDBDown:STATe	ON OFF	6.53
CALCulate<1 2>:MARKer<1...4>:FUNCTion:NDBDown:TIME?		6.54

Alphabetical List of Remote Commands

Command	Parameter	Page
CALCulate<1 2>:MARKer<1...4>:FUNction:NOISe:RESult?		6.56
CALCulate<1 2>:MARKer<1...4>:FUNction:NOISe[:STATe]	ON OFF	6.55
CALCulate<1 2>:MARKer<1...4>:FUNction:POWer:MODE	WRITe MAXHold	6.70
CALCulate<1 2>:MARKer<1...4>:FUNction:POWer:PRESet	NADC TETRA PDC PHS CDPD FWCDma RWCDma F8CDma R8CDma F19Cdma R19Cdma FW3Gppcdma RW3Gppcdma D2CDma S2CDma M2CDma FIS95A RIS95A FIS95C0 RIS95C0 FJ008 RJ008 FIS95C1 RIS95C1 TCDMa NONE AWLan BWLan WIMax WIBro	6.69
CALCulate<1 2>:MARKer<1...4>:FUNction:POWer:RESult:PHZ	ON OFF	6.68
CALCulate<1 2>:MARKer<1...4>:FUNction:POWer:RESult?	ACPower CPower MCACpower OBANdwidth OBWidth CN CN0	6.65
CALCulate<1 2>:MARKer<1...4>:FUNction:POWer:SElect	ACPower CPower MCACpower OBANdwidth OBWidth CN CN0	6.64
CALCulate<1 2>:MARKer<1...4>:FUNction:POWer:STANdard:CATalog?		6.70
CALCulate<1 2>:MARKer<1...4>:FUNction:POWer:STANdard:DElete	<name>	6.70
CALCulate<1 2>:MARKer<1...4>:FUNction:POWer[:STATe]	OFF	6.69
CALCulate<1 2>:MARKer<1...4>:FUNction:REFerence		6.60
CALCulate<1 2>:MARKer<1...4>:FUNction:STRack:BAWdth BWidth	10Hz to MAX(SPAN)	6.73
CALCulate<1 2>:MARKer<1...4>:FUNction:STRack[:STATe]	ON OFF	6.73
CALCulate<1 2>:MARKer<1...4>:FUNction:STRack:THReshold	-330dBm to +30dBm	6.73
CALCulate<1 2>:MARKer<1...4>:FUNction:STRack:TRACe	1 to 3	6.74
CALCulate<1 2>:MARKer<1...4>:FUNction:SUMMery:AOff		6.85
CALCulate<1 2>:MARKer<1...4>:FUNction:SUMMery:AVERAge	ON OFF	6.84
CALCulate<1 2>:MARKer<1...4>:FUNction:SUMMery:MEAN:AVERAge:RESult?		6.80
CALCulate<1 2>:MARKer<1...4>:FUNction:SUMMery:MEAN:PHOLd:RESult?		6.81
CALCulate<1 2>:MARKer<1...4>:FUNction:SUMMery:MEAN:RESult?		6.80
CALCulate<1 2>:MARKer<1...4>:FUNction:SUMMery:MEAN[:STATe]	ON OFF	6.79
CALCulate<1 2>:MARKer<1...4>:FUNction:SUMMery:MODE	ABSolute RELative	6.84
CALCulate<1 2>:MARKer<1...4>:FUNction:SUMMery:PHOLd	ON OFF	6.83
CALCulate<1 2>:MARKer<1...4>:FUNction:SUMMery:PPEak:AVERAge:RESult?		6.76
CALCulate<1 2>:MARKer<1...4>:FUNction:SUMMery:PPEak:PHOLd:RESult?		6.77
CALCulate<1 2>:MARKer<1...4>:FUNction:SUMMery:PPEak:RESult?		6.75
CALCulate<1 2>:MARKer<1...4>:FUNction:SUMMery:PPEak[:STATe]	ON OFF	6.75
CALCulate<1 2>:MARKer<1...4>:FUNction:SUMMery:REFerence:AUTO	ONCE	6.85
CALCulate<1 2>:MARKer<1...4>:FUNction:SUMMery:RMS:AVERAge:RESult?		6.78
CALCulate<1 2>:MARKer<1...4>:FUNction:SUMMery:RMS:PHOLd:RESult?		6.78
CALCulate<1 2>:MARKer<1...4>:FUNction:SUMMery:RMS:RESult?		6.77
CALCulate<1 2>:MARKer<1...4>:FUNction:SUMMery:RMS[:STATe]	ON OFF	6.77
CALCulate<1 2>:MARKer<1...4>:FUNction:SUMMery:SDEVIation:AVERAge:RESult?		6.82
CALCulate<1 2>:MARKer<1...4>:FUNction:SUMMery:SDEVIation:PHOLd:RESult?		6.83
CALCulate<1 2>:MARKer<1...4>:FUNction:SUMMery:SDEVIation:RESult?		6.82
CALCulate<1 2>:MARKer<1...4>:FUNction:SUMMery:SDEVIation[:STATe]	ON OFF	6.81
CALCulate<1 2>:MARKer<1...4>:FUNction:SUMMery[:STATe]	ON OFF	6.75
CALCulate<1 2>:MARKer<1...4>:FUNction:TOI:RESult?		6.59
CALCulate<1 2>:MARKer<1...4>:FUNction:TOI[:STATe]	ON OFF	6.59

Alphabetical List of Remote Commands

Command	Parameter	Page
CALCulate<1 2>:MARKer<1...4>:FUNction:ZOOM	<numeric_value>	6.55
CALCulate<1 2>:MARKer<1...4>:LOEXclude	ON OFF	6.46
CALCulate<1 2>:MARKer<1...4>:MAXimum:AUTO	ON OFF	6.48
CALCulate<1 2>:MARKer<1...4>:MAXimum:LEFT		6.48
CALCulate<1 2>:MARKer<1...4>:MAXimum:NEXT		6.47
CALCulate<1 2>:MARKer<1...4>:MAXimum[:PEAK]		6.47
CALCulate<1 2>:MARKer<1...4>:MAXimum:RIGHT		6.48
CALCulate<1 2>:MARKer<1...4>:MINimum:AUTO	ON OFF	6.49
CALCulate<1 2>:MARKer<1...4>:MINimum:LEFT		6.50
CALCulate<1 2>:MARKer<1...4>:MINimum:NEXT		6.49
CALCulate<1 2>:MARKer<1...4>:MINimum[:PEAK]		6.49
CALCulate<1 2>:MARKer<1...4>:MINimum:RIGHT		6.50
CALCulate<1 2>:MARKer<1...4>:PEXCursion	<numeric_value>	6.50
CALCulate<1 2>:MARKer<1...4>:SCOupled[:STATe]	ON OFF	6.46
CALCulate<1 2>:MARKer<1...4>[:STATe]	ON OFF	6.42
CALCulate<1 2>:MARKer<1...4>:TRACe	1 to 3	6.42
CALCulate<1 2>:MARKer<1...4>:X	0 to MAX (frequency sweep time)	6.42
CALCulate<1 2>:MARKer<1...4>:X:SLIMits:LEFT	0 to MAX (frequency sweep time)	6.43
CALCulate<1 2>:MARKer<1...4>:X:SLIMits:RIGHT	0 to MAX (frequency sweep time)	6.44
CALCulate<1 2>:MARKer<1...4>:X:SLIMits[:STATe]	ON OFF	6.43
CALCulate<1 2>:MARKer<1...4>:Y:PERCent	0 to 100%	6.47
CALCulate<1 2>:MARKer<1...4>:Y?		6.46
CALCulate<1 2>:MATH[:EXPRession][:DEFine]	(<expr>)	6.87
CALCulate<1 2>:MATH:MODE	LINear LOGarithmic POWER	6.88
CALCulate<1 2>:MATH:POSition	-100PCT to 200PCT	6.87
CALCulate<1 2>:MATH:STATe	ON OFF	6.87
CALCulate<1 2>:PEAKsearch PSEArch:ADD	<numeric value>	6.89
CALCulate<1 2>:PEAKsearch PSEArch:AUTO	ON OFF	6.89
CALCulate<1 2>:PEAKsearch PSEArch:CLEAr[:IMMEdiate]		6.89
CALCulate<1 2>:PEAKsearch PSEArch[:IMMEdiate]		6.89
CALCulate<1 2>:PEAKsearch PSEArch:MARGIn	MINimum .. MAXimum	6.90
CALCulate<1 2>:PEAKsearch PSEArch:METHod	SUBRange PEAK	6.90
CALCulate<1 2>:PEAKsearch PSEArch:SUBRanges	1 to 500	6.90
CALCulate<1 2>:STATistics:X:MPOSition	0 ... 100	6.94
CALCulate<1 2>:THReshold	MINimum to MAXimum (depending on current unit)	6.95
CALCulate<1 2>:THReshold:STATe	ON OFF	6.95
CALCulate<1 2>:TLINe<1 2>	0 to 1000s	6.96
CALCulate<1 2>:TLINe<1 2>:STATe	ON OFF	6.96
CALCulate<1 2>:UNIT:POWER	DBM V A W DBPW WATT DBUV DBMV VOLT DBUA AMPere DBPT DBUV_M DBUA_M	6.97
CALibration:ABORT		6.98
CALibration[:ALL]?		6.98
CALibration:RESult?		6.99
CALibration:STATe	ON OFF	6.99
DIAGnostic<1 2>:SERvice:CSOource[:POWER]	<numeric_value>	6.101
DIAGnostic<1 2>:SERvice:HWINfo?		6.102
DIAGnostic<1 2>:SERvice:INPut:PULSed:PRATe	10 kHz 100 kHz 200 kHz 500 kHz 1 MHz 2 MHz 4 MHz 8 MHz	6.100
DIAGnostic<1 2>:SERvice:INPut:PULSed[:STATe]	ON OFF	6.100
DIAGnostic<1 2>:SERvice:INPut[:SElect]	CALibration RF	6.100
DIAGnostic<1 2>:SERvice:NSOource	ON OFF	6.101
DIAGnostic<1 2>:SERvice:SFUNction	'<string>'	6.100
DIAGnostic<1 2>:SERvice:STESt:RESult?		6.101

Alphabetical List of Remote Commands

Command	Parameter	Page
DISPlay:ANNotation:FREQuency	ON OFF	6.103
DISPlay:BARGraph:LEVel:LOWer?		6.111
DISPlay:BARGraph:LEVel:UPPer?		6.112
DISPlay:BARGraph:PHOLd	ON OFF	6.112
DISPlay:BARGraph:PHOLd:RESet		6.112
DISPlay:CMAP<1...34>:DEFault<1 2>		6.104
DISPlay:CMAP<1...34>:HSL	<hue>, <sat>, <lum>	6.104
DISPlay:CMAP<1...34>:PDEFined	BLACK BLUE BROWn GREen CYAN RED MAGenta YELLow WHITe DGRAY LGRAY LBLUe LGREen LCYan LRED LMAGenta	6.105
DISPlay:FORMat	SINGLE SPLit	6.103
DISPlay:LOGO	ON OFF	6.103
DISPlay:PSAVe:HOLDoff	1 to 60	6.104
DISPlay:PSAVe[:STATe]	ON OFF	6.103
DISPlay[:WINDow<1 2>]:ACTive?		6.106
DISPlay[:WINDow<1 2>]:SELect		6.106
DISPlay[:WINDow<1 2>]:SIZE	LARGE SMALl	6.106
DISPlay[:WINDow<1 2>]:TEXT[:DATA]	<string>	6.107
DISPlay[:WINDow<1 2>]:TEXT:STATe	ON OFF	6.107
DISPlay[:WINDow<1 2>]:TIME	ON OFF	6.107
DISPlay[:WINDow<1 2>]:TRACe<1...3>:MODE	WRITe VIEW AVERAge MAXHold MINHold	6.110
DISPlay[:WINDow<1 2>]:TRACe<1...3>:MODE:HCONTinuous	ON OFF	6.111
DISPlay[:WINDow<1 2>]:TRACe<1...3>[:STATe]	ON OFF	6.111
DISPlay[:WINDow<1 2>]:TRACe<1...3>:SYMBOL	CROSSs OFF	6.111
DISPlay[:WINDow<1 2>]:TRACe<1...3>:X[:SCALE]:ZOOM	ON OFF	6.107
DISPlay[:WINDow<1 2>]:TRACe<1...3>:X:SPACing	LINear LOGarithmic	6.107
DISPlay[:WINDow<1 2>]:TRACe<1...3>:Y[:SCALE]	10dB to 200dB	6.108
DISPlay[:WINDow<1 2>]:TRACe<1...3>:Y[:SCALE]:BOTTom	<numeric_value>	6.109
DISPlay[:WINDow<1 2>]:TRACe<1...3>:Y[:SCALE]:MODE	ABSolute RELative	6.108
DISPlay[:WINDow<1 2>]:TRACe<1...3>:Y[:SCALE]:RLEVel	-130dBm to 30dBm	6.108
DISPlay[:WINDow<1 2>]:TRACe<1...3>:Y[:SCALE]:RLEVel:OFFSet	-200dB to 200dB	6.108
DISPlay[:WINDow<1 2>]:TRACe<1...3>:Y[:SCALE]:RPOSITion	0 to 100PCT	6.109
DISPlay[:WINDow<1 2>]:TRACe<1...3>:Y[:SCALE]:RVALue	<numeric_value>	6.109
DISPlay[:WINDow<1 2>]:TRACe<1...3>:Y:SPACing	LINear LOGarithmic LDB	6.109
DISPlay[:WINDow<1 2>]:TRACe<1...3>:Y:UNIT?		6.110
FORMat[:DATA]	ASCIi REAL UINt [, 8 32]	6.113
FORMat:DEXPort:DSEParator	POINT COMMA	6.113
HCOPy:ABORT		6.114
HCOPy:CMAP<1 to 34>:PDEFined	BLACK BLUE BROWn GREen CYAN RED MAGenta YELLow WHITe DGRAY LGRAY LBLUe LGREen LCYan LRED LMAGenta	6.115
HCOPy:CMAP<1...34>:DEFault<1 2 3>		6.114
HCOPy:CMAP<1...34>:HSL	<hue>, <sat>, <lum>	6.114
HCOPy:DESTination<1 2>	<string>	6.116
HCOPy:DEvice:COLor	ON OFF	6.116
HCOPy:DEvice:LANGUage<1 2>	GDI WMF EWMF BMP	6.117
HCOPy[:IMMediate<1 2>]		6.117
HCOPy:ITEM:ALL		6.118
HCOPy:ITEM:WINDow<1 2>:TABLe:STATe	ON OFF	6.118
HCOPy:ITEM:WINDow<1 2>:TEXT	<string>	6.118
HCOPy:ITEM:WINDow<1 2>:TRACe:STATe	ON OFF	6.118
HCOPy:PAGE:ORientation<1 2>	LANDscape PORTRait	6.119
HOLD		6.11

Alphabetical List of Remote Commands

Command	Parameter	Page
INITiate<1 2>:CONMeas		6.121
INITiate<1 2>:CONTinuous	ON OFF	6.120
INITiate<1 2>:DISPlay	ON OFF	6.122
INITiate<1 2>:EMItest		6.123
INITiate<1 2>:ESpectrum		6.122
INITiate<1 2>:FMEasurement		6.123
INITiate<1 2>:[IMMEDIATE]		6.121
INITiate<1 2>:SPURious		6.123
INPut<1 2>:ATenuation	0 to 75 dB	6.124
INPut<1 2>:ATenuation:AUTO	ON OFF	6.124
INPut<1 2>:ATenuation:PROtection[:STATe]	ON OFF	6.124
INPut<1 2>:GAIN:AUTO	ON OFF	6.125
INPut<1 2>:GAIN:STATe	ON OFF	6.124
INPut<1 2>:IMPedance	50 75	6.126
INPut<1 2>:LISN:FILTer:HPAS[:STATe]	ON OFF	6.126
INPut<1 2>:LISN:PEARth	GRounded FLOating	6.125
INPut<1 2>:LISN:PHASe	L1 L2 L3 N	6.125
INPut<1 2>:LISN[:TYPE]	TWOPhase FOURphase ESH3Z5 ESH2Z5 ENV4200 ENV216 OFF	6.125
INPut<1 2>:PRESelection[:STATe]	ON OFF	6.126
INPut<1 2>:UPORt:STATe	ON OFF	6.127
INPut<1 2>:UPORt[:VALue]?		6.126
INSTrument:CONFigure<1 2>:DISPlay	SANalyzer RECeiver	6.129
INSTrument:CONFigure<1 2>:MIXed	ON OFF	6.129
INSTrument:COUPle	NONE RLeVel CF_B CF_A	6.129
INSTrument:COUPle:ATTenuation	ALL NONE	6.130
INSTrument:COUPle:BANDwidth BWIDth	ALL NONE	6.130
INSTrument:COUPle:CENTer	ALL NONE	6.130
INSTrument:COUPle:DEModulation	ALL NONE	6.130
INSTrument:COUPle:GAIN	ALL NONE	6.131
INSTrument:COUPle:MARKer	ALL NONE	6.131
INSTrument:COUPle:PRESelector	ALL NONE	6.131
INSTrument:COUPle:PROtection	ALL NONE	6.131
INSTrument:COUPle:SPAN	ALL NONE	6.132
INSTrument:NSElect	<numeric value>	6.128
INSTrument[:SElect]	SANalyzer RECeiver ADEMod	6.128
MMEMemory:CATalog:LONG?	<path>	6.134
MMEMemory:CATalog?	<path>	6.133
MMEMemory:CDIRectory	<directory_name>	6.134
MMEMemory:CLEar:ALL		6.135
MMEMemory:CLEar:STATe	1,<file_name>	6.134
MMEMemory:COMMeNT	<string>	6.135
MMEMemory:COpy	<file_source>,<file_destination>	6.135
MMEMemory:DATA	<file_name>[,<block data>]	6.135
MMEMemory:DELeTe	<file_name>	6.136
MMEMemory:INITialize	<msus>	6.136
MMEMemory:LOAD:AUTO	1,<file_name>	6.137
MMEMemory:LOAD:STATe	1,<file_name>	6.137
MMEMemory:MDIRectory	<directory_name>	6.137
MMEMemory:MOVE	<file_source>,<file_destination>	6.138
MMEMemory:MSIS	<device>	6.138
MMEMemory:NAME	<file_name>	6.138
MMEMemory:RDIRectory	<directory_name>	6.139
MMEMemory:SElect[:ITEM]:ALL		6.139
MMEMemory:SElect[:ITEM]:CLISt	ON OFF	6.139

Alphabetical List of Remote Commands

Command	Parameter	Page
MMEMory:SElect[:ITEM]:DEFault		6.139
MMEMory:SElect[:ITEM]:FINAl	ON OFF	6.141
MMEMory:SElect[:ITEM]:HWSettings	ON OFF	6.140
MMEMory:SElect[:ITEM]:LINES:ALL	ON OFF	6.140
MMEMory:SElect[:ITEM]:NONE		6.141
MMEMory:SElect[:ITEM]:SCData	ON OFF	6.141
MMEMory:SElect[:ITEM]:TRACe[:ACTive]	ON OFF	6.141
MMEMory:SElect[:ITEM]:TRANsducer:ALL	ON OFF	6.141
MMEMory:STORe:FINAl	<file_name>	6.142
MMEMory:STORe<1 2>:MARKer	<file_name>	6.142
MMEMory:STORe<1 2>:PEAKlist	<file_name>	6.142
MMEMory:STORe<1 2>:SPURious	<file_name>	6.143
MMEMory:STORe<1 2>:STATe	1, <file_name>	6.143
MMEMory:STORe<1 2>:TRACe	1 to 3, <file_name>	6.143
OUTPut:UPORt:STATe	ON OFF	6.146
OUTPut:UPORt[:VALue]	#B00000000 to #B11111111	6.146
OUTPut<1 2>[:STATe]	ON OFF	6.146
[SENSe<1 2>:]AVERAge:COUNT	0 to 32767	6.148
[SENSe<1 2>:]AVERAge[:STATe<1...3>]	ON OFF	6.148
[SENSe<1 2>:]AVERAge:TYPE	VIDeo LINear	6.149
[SENSe<1 2>:]BANDwidth BWIDth:FFT	WIDE AUTO NARROW	6.150
[SENSe<1 2>:]BANDwidth BWIDth[:RESolution]	10 Hz to 3 MHz	6.150
[SENSe<1 2>:]BANDwidth BWIDth[:RESolution]:AUTO	ON OFF	6.151
[SENSe<1 2>:]BANDwidth BWIDth[:RESolution]:RATio	0.0001 to 1	6.151
[SENSe<1 2>:]BANDwidth BWIDth[:RESolution]:TYPE	NORMal CFILter RRC FFT NOISe PULSe	6.151
[SENSe<1 2>:]BANDwidth BWIDth:VIDeo	1Hz to 10MHz	6.152
[SENSe<1 2>:]BANDwidth BWIDth:VIDeo:AUTO	ON OFF	6.152
[SENSe<1 2>:]BANDwidth BWIDth:VIDeo:RATio	0.01 to 1000	6.152
[SENSe<1 2>:]BANDwidth BWIDth:VIDeo:TYPE	LINear LOGarithmic	6.153
[SENSe<1 2>:]CORRection:COLLect[:ACQuire]	THRough OPEN	6.154
[SENSe<1 2>:]CORRection:METhod	TRANSmision REFLection	6.154
[SENSe<1 2>:]CORRection:RECall		6.155
[SENSe<1 2>:]CORRection[:STATe]	ON OFF	6.154
[SENSe<1 2>:]CORRection:TRANsducer:ACTive?		6.155
[SENSe<1 2>:]CORRection:TRANsducer:ADJust:RLEVel[:STATe]	ON OFF	6.158
[SENSe<1 2>:]CORRection:TRANsducer:CATalog?		6.155
[SENSe<1 2>:]CORRection:TRANsducer:COMMeNt	<string>	6.157
[SENSe<1 2>:]CORRection:TRANsducer:DATA	<freq>, <level>..	6.157
[SENSe<1 2>:]CORRection:TRANsducer:DELeTe		6.158
[SENSe<1 2>:]CORRection:TRANsducer:GENerate	<name>	6.156
[SENSe<1 2>:]CORRection:TRANsducer:SCALing	LINear LOGarithmic	6.157
[SENSe<1 2>:]CORRection:TRANsducer:SElect	<name>	6.156
[SENSe<1 2>:]CORRection:TRANsducer[:STATe]	ON OFF	6.157
[SENSe<1 2>:]CORRection:TRANsducer:UNIT	<string>	6.156
[SENSe<1 2>:]CORRection:TRANsducer:VIEW	ON OFF	6.158
[SENSe<1 2>:]CORRection:TSET:BReak	ON OFF	6.159
[SENSe<1 2>:]CORRection:TSET:CATalog?		6.159
[SENSe<1 2>:]CORRection:TSET:COMMeNt	<string>	6.159
[SENSe<1 2>:]CORRection:TSET:DELeTe		6.160
[SENSe<1 2>:]CORRection:TSET:RANGe<1 to 10>	<freq>, <freq>, <name>..	6.160
[SENSe<1 2>:]CORRection:TSET:SElect	<name>	6.158
[SENSe<1 2>:]CORRection:TSET[:STATe]	ON OFF	6.160
[SENSe<1 2>:]CORRection:TSET:UNIT	<string>	6.159
[SENSe<1 2>:]DEMod	OFF AM FM	6.161

Alphabetical List of Remote Commands

Command	Parameter	Page
[SENSe<1 2>:]DEMod:SQUelch:LEVel	<numeric_value> MIN MAX DEF	6.161
[SENSe<1 2>:]DETEctor<1..3>:FMEasurement	NEGative POSitive RMS AVERAge QPEak CAVERage CRMS	6.163
[SENSe<1 2>:]DETEctor<1..3>[:FUNction]	APEak NEGative POSitive SAMPlE RMS AVERAge QPEak CAVERage CRMS	6.162
[SENSe<1 2>:]DETEctor<1..3>[:FUNction]:AUTO	ON OFF	6.162
[SENSe<1 2>:]DETEctor<1..3>:RECeiver[:FUNction]	POSitive NEGative RMS AVERAge QPEak CAVERage CRMS	6.163
[SENSe<1 2>:]ESpectrum:BWIDth	numeric_value	6.163
[SENSe<1 2>:]ESpectrum:FILTer:RRC:ALPHa	0...1	6.164
[SENSe<1 2>:]ESpectrum:FILTer:RRC[:STATe]	ON OFF	6.163
[SENSe<1 2>:]ESpectrum:PRESet:REStore		6.164
[SENSe<1 2>:]ESpectrum:PRESet[:STANdard]	'xml_file'	6.164
[SENSe<1 2>:]ESpectrum:RANGe<1..20>:INSert	AFTer BEFore	6.168
[SENSe<1 2>:]ESpectrum:RANGe<1..20>:LIMit:ABSolute:START	<numeric_value>	6.167
[SENSe<1 2>:]ESpectrum:RANGe<1..20>:LIMit:ABSolute:STOP	<numeric_value>	6.167
[SENSe<1 2>:]ESpectrum:RANGe<1..20>:LIMit:RELative:START	<numeric_value>	6.168
[SENSe<1 2>:]ESpectrum:RANGe<1..20>:LIMit:RELative:STOP	<numeric_value>	6.168
[SENSe<1 2>:]ESpectrum:RANGe<1..20>:LIMit:STATe	ABSolute RELative AND OR	6.168
[SENSe<1 2>:]ESpectrum:RANGe<1..20>:BANDwidth[:RESolution]	<numeric_value>	6.165
[SENSe<1 2>:]ESpectrum:RANGe<1..20>:BANDwidth:VIDeo	<numeric_value>	6.165
[SENSe<1 2>:]ESpectrum:RANGe<1..20>:COUNt?		6.165
[SENSe<1 2>:]ESpectrum:RANGe<1..20>:DELeTe		6.165
[SENSe<1 2>:]ESpectrum:RANGe<1..20>:FILTer:TYPE	NORMal CFILTer RRC PULSe	6.166
[SENSe<1 2>:]ESpectrum:RANGe<1..20>[:FREQuency]:START	<numeric_value>	6.166
[SENSe<1 2>:]ESpectrum:RANGe<1..20>[:FREQuency]:STOP	<numeric_value>	6.166
[SENSe<1 2>:]ESpectrum:RANGe<1..20>:INPut:ATTenuation	<numeric_value>	6.166
[SENSe<1 2>:]ESpectrum:RANGe<1..20>:INPut:ATTenuation:AUTO	ON OFF	6.167
[SENSe<1 2>:]ESpectrum:RANGe<1..20>:INPut:GAIN:STATe	ON OFF	6.167
[SENSe<1 2>:]ESpectrum:RANGe<1..20>:RLEVel	<numeric_value>	6.169
[SENSe<1 2>:]ESpectrum:RANGe<1..20>:SWEep:TIME	<numeric_value>	6.169
[SENSe<1 2>:]ESpectrum:RANGe<1..20>:SWEep:TIME:AUTO	ON OFF	6.169
[SENSe<1 2>:]ESpectrum:RANGe<1..20>:TRANsducer	<string>	6.169
[SENSe<1 2>:]ESpectrum:RRANGe?		6.170
[SENSe<1 2>:]ESpectrum:RTYPE PEAK CPOWer		6.170
[SENSe<1 2>:]FMEasurement:AUTO	ON OFF	6.171
[SENSe<1 2>:]FMEasurement:LISN:FILTer:HPAS[:STATe]	ON OFF	6.172
[SENSe<1 2>:]FMEasurement:LISN:PEARth	GROunded FLOating[,GROunded FLOating]	6.172
[SENSe<1 2>:]FMEasurement:LISN:PHASe	L1 L2 L3 N[,[L1 L2 L3 N],...]	6.172
[SENSe<1 2>:]FMEasurement:LISN[:TYPE]	TWOPhase FOURPhase ESH3Z5 ESH2Z5 ENV4200 ENV216 OFF	6.172
[SENSe<1 2>:]FMEasurement:NBBB:LEVel	<numeric_value>:	6.171
[SENSe<1 2>:]FMEasurement:NBBB[:STATe] ON OFF	<numeric_value>:	6.171
[SENSe<1 2>:]FMEasurement:THReshold[:STATe]	ON OFF	6.171
[SENSe<1 2>:]FMEasurement:TIME	<numeric_value>	6.173
[SENSe<1 2>:]FREQuency:CENTer	0 to fmax	6.174
[SENSe<1 2>:]FREQuency:CENTer:STEP	0 to fmax	6.174
[SENSe<1 2>:]FREQuency:CENTer:STEP:LINK	SPAN RBW OFF	6.174
[SENSe<1 2>:]FREQuency:CENTer:STEP:LINK:FACTor	1 to 100 PCT	6.174
[SENSe<1 2>:]FREQuency:MODE	CW FIXed SWEep SCAN	6.175
[SENSe<1 2>:]FREQuency:OFFSet	<numeric_value>	6.176
[SENSe<1 2>:]FREQuency:SPAN	0 to fmax	6.174
[SENSe<1 2>:]FREQuency:SPAN:FULL		6.175
[SENSe<1 2>:]FREQuency:START	0 to fmax	6.175

Alphabetical List of Remote Commands

Command	Parameter	Page
[SENSe<1 2>]:FREQuency:STOP	0 to fmax	6.175
[SENSe<1 2>]:LIST:POWer:RESult?		6.177
[SENSe<1 2>]:LIST:POWer[:SEQuence]	<analyzer freq>, <ref level>, <rf att>, OFF, <el att>, <filter type>, <rbw>, <vbw>, <meas time>, <trigger level>	6.178
[SENSe<1 2>]:LIST:POWer:SET	<PEAK meas>, <RMS meas>, <AVG meas>, <trigger mode>, <trigger slope>, <trigger offset>, <gate length>	6.180
[SENSe<1 2>]:LIST:POWer:SET:AVERAge:TYPE	LINear LOGarithmic	6.181
[SENSe<1 2>]:LIST:POWer:STATe	OFF	6.181
[SENSe<1 2>]:LIST:RANGe<1...20>:LIMit	-200dB to +200dB	6.184
[SENSe<1 2>]:LIST:RANGe<1...20>:LIMit:STATe	ON OFF	6.184
[SENSe<1 2>]:LIST:RANGe<1...20>:BANDwidth[:RESolution]	<numeric_value>	6.181
[SENSe<1 2>]:LIST:RANGe<1...20>:BANDwidth:VIDeo	<numeric_value>	6.182
[SENSe<1 2>]:LIST:RANGe<1...20>:BREAk	ON OFF	6.182
[SENSe<1 2>]:LIST:RANGe<1...20>:COUNt?		6.182
[SENSe<1 2>]:LIST:RANGe<1...20>:DELeTe		6.182
[SENSe<1 2>]:LIST:RANGe<1...20>:DETEctor	APEak NEGative POSitive SAMPlE RMS AVERAge	6.182
[SENSe<1 2>]:LIST:RANGe<1...20>:FILTer:TYPE	NORMal CHANnel RRC PULSe	6.183
[SENSe<1 2>]:LIST:RANGe<1...20>[:FREQuency]:START	<numeric_value>	6.183
[SENSe<1 2>]:LIST:RANGe<1...20>[:FREQuency]:STOP	<numeric_value>	6.183
[SENSe<1 2>]:LIST:RANGe<1...20>:INPut:ATTenuation	<numeric_value>	6.183
[SENSe<1 2>]:LIST:RANGe<1...20>:INPut:ATTenuation:AUTO	ON OFF	6.183
[SENSe<1 2>]:LIST:RANGe<1...20>:INPut:GAIN:STATe	ON OFF	6.184
[SENSe<1 2>]:LIST:RANGe<1...20>:POINts	<numeric_value>	6.184
[SENSe<1 2>]:LIST:RANGe<1...20>:RLEVel	<numeric_value>	6.185
[SENSe<1 2>]:LIST:RANGe<1...20>:SWEp:TIME	<numeric_value>	6.185
[SENSe<1 2>]:LIST:RANGe<1...20>:SWEp:TIME:AUTO	ON OFF	6.185
[SENSe<1 2>]:LIST:RANGe<1...20>:TRANsducer	<string>	6.185
[SENSe<1 2>]:MPOWer:RESult[:LIST]?		6.189
[SENSe<1 2>]:MPOWer:RESult:MIN?		6.190
[SENSe<1 2>]:MPOWer[:SEQuence]	<analyzer freq>, <rbw>, <meas time>, <trigger source>, <trigger level>, <trigger offset>, <type of meas>, <# of meas>	6.187
[SENSe<1 2>]:POWer:ACHannel:ACPairs	0 to 12	6.192
[SENSe<1 2>]:POWer:ACHannel:BANDwidth BWIDth:ACHannel	100 Hz to 1000 MHz	6.192
[SENSe<1 2>]:POWer:ACHannel:BANDwidth BWIDth:ALTErnate<1...11>	100 Hz to 1000 MHz	6.192
[SENSe<1 2>]:POWer:ACHannel:BANDwidth BWIDth[:CHANnel]	100 Hz to 1000 MHz	6.192
[SENSe<1 2>]:POWer:ACHannel:FILTer:ALPHa:ACHannel	0...1	6.193
[SENSe<1 2>]:POWer:ACHannel:FILTer:ALPHa:ALL	0...1	6.193
[SENSe<1 2>]:POWer:ACHannel:FILTer:ALPHa:ALTErnate<1...11>	0...1	6.193
[SENSe<1 2>]:POWer:ACHannel:FILTer:ALPHa:CHANnel<1...12>	0...1	6.193
[SENSe<1 2>]:POWer:ACHannel:FILTer:STATe:ACHannel	ON OFF	6.194
[SENSe<1 2>]:POWer:ACHannel:FILTer:STATe:ALL	ON OFF	6.194
[SENSe<1 2>]:POWer:ACHannel:FILTer:STATe:ALTErnate<1 to 11>	ON OFF	6.194
[SENSe<1 2>]:POWer:ACHannel:FILTer:STATe:CHANnel<1...12>	ON OFF	6.194
[SENSe<1 2>]:POWer:ACHannel:MODE	ABSolute RELative	6.195
[SENSe<1 2>]:POWer:ACHannel:PRESet	ACPowEr CPOWEr MCACpowEr OBANdwidth OBWidth CN CN0	6.196
[SENSe<1 2>]:POWer:ACHannel:PRESet:RLEVel		6.197
[SENSe<1 2>]:POWer:ACHannel:PRESet:RLEVel:OFFSet	0 ... 100 dB	6.195
[SENSe<1 2>]:POWer:ACHannel:REFerence:AUTO	ONCE	6.195
[SENSe<1 2>]:POWer:ACHannel:REFerence:TXCHannel:AUTO	MINimum MAXimum LHIGHest OFF	6.195
[SENSe<1 2>]:POWer:ACHannel:REFerence:TXCHannel:MANual	1 to 12	6.196

Alphabetical List of Remote Commands

Command	Parameter	Page
[SENSe<1 2>:]POWer:ACHannel:SPACing:ACHannel	100 Hz to 2000 MHz	6.191
[SENSe<1 2>:]POWer:ACHannel:SPACing:ALternate<1 to 11>	100 Hz to 2000 MHz	6.191
[SENSe<1 2>:]POWer:ACHannel:SPACing:CHANnel<1 to 11>	100 Hz to 2000 MHz	6.190
[SENSe<1 2>:]POWer:ACHannel:TXCHannel:COUNT	1 to 12	6.191
[SENSe<1 2>:]POWer:BANDwidth BWIDth	10 to 99.9PCT	6.197
[SENSe<1 2>:]POWer:HSPEED	ON OFF	6.197
[SENSe<1 2>:]POWer:NCORrection	ON OFF	6.198
[SENSe<1 2>:]POWer:TRACe	1 to 3	6.198
[SENSe<1 2>:]ROSCillator:EXTernal:FREQUency	1MHz to 20MHz	6.199
[SENSe<1 2>:]ROSCillator:EXTernal:PLL	NORMal WIDE	6.200
[SENSe<1 2>:]ROSCillator:INTernal]:TUNe	0 to 4095	6.200
[SENSe<1 2>:]ROSCillator:INTernal]:TUNe:SAVe		6.200
[SENSe<1 2>:]ROSCillator:SOURce	INTernal EXTernal EAUto	6.199
[SENSe<1 2>:]ROSCillator:SOURce:EAUto?		6.199
[SENSe<1 2>:]SCAN<1 to 10>:BANDwidth:RESolution	fmin to fmax	6.201
[SENSe<1 2>:]SCAN<1 to 10>:INPut:ATTenuation	dBmin to dBmax	6.202
[SENSe<1 2>:]SCAN<1 to 10>:INPut:ATTenuation:AUTO	ON OFF	6.202
[SENSe<1 2>:]SCAN<1 to 10>:INPut:GAIN:AUTO	ON OFF	6.202
[SENSe<1 2>:]SCAN<1 to 10>:INPut:GAIN[:STATE]	ON OFF	6.202
[SENSe<1 2>:]SCAN<1 to 10>:RANGes[:COUNT]	1 to 10	6.203
[SENSe<1 2>:]SCAN<1 to 10>:START	fmin to fmax	6.201
[SENSe<1 2>:]SCAN<1 to 10>:STEP	fmin to fmax	6.201
[SENSe<1 2>:]SCAN<1 to 10>:STOP	fmin to fmax	6.201
[SENSe<1 2>:]SCAN<1 to 10>:TIME	33 µs to 100 s	6.202
[SENSe<1 2>:]SWEp:COUNT	0 to 32767	6.204
[SENSe<1 2>:]SWEp:COUNT:CURRent?		6.205
[SENSe<1 2>:]SWEp:EGATe	ON OFF	6.205
[SENSe<1 2>:]SWEp:EGATe:HOLDoff	125 ns to 100 s	6.206
[SENSe<1 2>:]SWEp:EGATe:LENGth	0 to 100 s	6.206
[SENSe<1 2>:]SWEp:EGATe:POLarity	POSitive NEGative	6.206
[SENSe<1 2>:]SWEp:EGATe:SOURce	EXTernal IFPower RFPower	6.206
[SENSe<1 2>:]SWEp:EGATe:TRACe<1..3>COMMeNT		6.207
[SENSe<1 2>:]SWEp:EGATe:TRACe<1..3>PERiod	<value>	6.208
[SENSe<1 2>:]SWEp:EGATe:TRACe<1..3>START<1..3> STOP<1..3>	<value>	6.207
[SENSe<1 2>:]SWEp:EGATe:TRACe<1..3>STATe<1..3>	ON OFF	6.207
[SENSe<1 2>:]SWEp:EGATe:TYPE	LEVel EDGE	6.206
[SENSe<1 2>:]SWEp:MODE	AUTO LIST ESpectrum	6.208
[SENSe<1 2>:]SWEp:POINts	125, 251, 501, 1001, 2001, 4001, 8001	6.208
[SENSe<1 2>:]SWEp:SPACing	LINear LOGarithmic AUTO	6.208
[SENSe<1 2>:]SWEp:TIME	33 µs to 100 s (receiver) 2,5 ms to 16000 s (frequency domain) 1 µs to 16000 s (time domain)	6.204
[SENSe<1 2>:]SWEp:TIME:AUTO	ON OFF	6.204
[SENSe<1 2>:]TV:CCVS	INTernal EXTernal	6.209
[SENSe<1 2>:]TV[:STATe]	ON OFF	6.209
SOURce<1 2>:AM:STATe	ON OFF	6.210
SOURce<1 2>:DM:STATe	ON OFF	6.210
SOURce<1 2>:EXTernal<1 2>:FREQUency[:FACTor]:DENominator	<numeric_value>	6.213
SOURce<1 2>:EXTernal<1 2>:FREQUency[:FACTor]:NUMerator	<numeric_value>	6.214
SOURce<1 2>:EXTernal<1 2>:FREQUency:OFFSet	<numeric_value>	6.214
SOURce<1 2>:EXTernal<1 2>:FREQUency:SWEp[:STATe]	ON OFF	6.215
SOURce<1 2>:EXTernal<1 2>:POWer[:LEVel]	<numeric_value>	6.215
SOURce<1 2>:EXTernal<1 2>:ROSCillator[:SOURce]	INTernal EXTernal	6.215
SOURce<1 2>:EXTernal<1 2>[:STATe]	ON OFF	6.213
SOURce<1 2>:FM:DEVIation	100Hz to 10MHz	6.211

Alphabetical List of Remote Commands

Command	Parameter	Page
SOURce<1 2>:FM:STATe	ON OFF	6.210
SOURce<1 2>:FREQuency:OFFSet	-150MHz to 150MHz	6.211
SOURce<1 2>:POWer[:LEVel][:IMMediate][:AMPLitude]	<numeric_value>	6.211
SOURce<1 2>:POWer[:LEVel][:IMMediate]:OFFSet	-200dB to +200dB	6.212
SOURce<1 2>:POWer:MODE	FIXed SWEEp	6.212
SOURce<1 2>:POWer:STARt	-30 dBm to 0 dBm	6.212
SOURce<1 2>:POWer:STOP	-30 dBm to 0 dBm	6.212
STATus:OPERation:CONDition?		6.216
STATus:OPERation:ENABLE	0 to 65535	6.216
STATus:OPERation[:EVENT]?		6.216
STATus:OPERation:NTRansition	0 to 65535	6.217
STATus:OPERation:PTRansition	0 to 65535	6.216
STATus:PRESet		6.217
STATus:QUEStionable:ACPLimit:CONDition?		6.221
STATus:QUEStionable:ACPLimit:ENABLE	0 to 65535	6.222
STATus:QUEStionable:ACPLimit[:EVENT]?		6.221
STATus:QUEStionable:ACPLimit:NTRansition	0 to 65535	6.222
STATus:QUEStionable:ACPLimit:PTRansition	0 to 65535	6.222
STATus:QUEStionable:CONDition?		6.217
STATus:QUEStionable:ENABLE	0 to 65535	6.218
STATus:QUEStionable[:EVENT]?		6.217
STATus:QUEStionable:FREQuency:CONDition?		6.222
STATus:QUEStionable:FREQuency:ENABLE	0 to 65535	6.223
STATus:QUEStionable:FREQuency[:EVENT]?		6.222
STATus:QUEStionable:FREQuency:NTRansition	0 to 65535	6.223
STATus:QUEStionable:FREQuency:PTRansition	0 to 65535	6.223
STATus:QUEStionable:LIMit<1 2> [:EVENT]?		6.219
STATus:QUEStionable:LIMit<1 2>:CONDition?		6.219
STATus:QUEStionable:LIMit<1 2>:ENABLE	0 to 65535	6.220
STATus:QUEStionable:LIMit<1 2>:NTRansition	0 to 65535	6.220
STATus:QUEStionable:LIMit<1 2>:PTRansition	0 to 65535	6.220
STATus:QUEStionable:LMARgin<1 2> [:EVENT]?		6.220
STATus:QUEStionable:LMARgin<1 2>:CONDition?		6.220
STATus:QUEStionable:LMARgin<1 2>:ENABLE	0 to 65535	6.221
STATus:QUEStionable:LMARgin<1 2>:NTRansition	0 to 65535	6.221
STATus:QUEStionable:LMARgin<1 2>:PTRansition	0 to 65535	6.221
STATus:QUEStionable:NTRansition	0 to 65535	6.218
STATus:QUEStionable:POWer:CONDition?		6.218
STATus:QUEStionable:POWer:ENABLE	0 to 65535	6.219
STATus:QUEStionable:POWer[:EVENT]?		6.218
STATus:QUEStionable:POWer:NTRansition	0 to 65535	6.219
STATus:QUEStionable:POWer:PTRansition	0 to 65535	6.219
STATus:QUEStionable:PTRansition	0 to 65535	6.218
STATus:QUEStionable:TRANsducer:CONDition?		6.223
STATus:QUEStionable:TRANsducer:ENABLE	0 to 65535	6.224
STATus:QUEStionable:TRANsducer[:EVENT]?		6.223
STATus:QUEStionable:TRANsducer:NTRansition	0 to 65535	6.224
STATus:QUEStionable:TRANsducer:PTRansition	0 to 65535	6.224
STATus:QUEue[:NEXT]?		6.224
SYSTem:COMMunicate:GPIB:RDEvice:COMMand	0...30,<command string>	6.226
SYSTem:COMMunicate:GPIB:RDEvice:GENerator<1 2>:ADDRess	0 to 30	6.225
SYSTem:COMMunicate:GPIB[:SELF]:ADDRess	0 to 30	6.225
SYSTem:COMMunicate:GPIB[:SELF]:RTERminator	LFEOI EOI	6.225
SYSTem:COMMunicate:PRINter:ENUMerate:FIRSt?		6.228
SYSTem:COMMunicate:PRINter:ENUMerate:NEXT?		6.229

Alphabetical List of Remote Commands

Command	Parameter	Page
SYSTem:COMMunicate:PRINter:SElect <1 2>	<printer_name>	6.229
SYSTem:COMMunicate:RDEvice:GENerator<1 2>:LINK	GPIB TTL	6.226
SYSTem:COMMunicate:RDEvice:GENerator<1 2>:TYPE	<name>	6.227
SYSTem:COMMunicate:SERial:CONTRol:DTR	IBFull OFF	6.227
SYSTem:COMMunicate:SERial:CONTRol:RTS	IBFull OFF	6.227
SYSTem:COMMunicate:SERial[:RECeive]:BAUD	110 300 600 1200 2400 9600 19200 38400 57600 115200 128000	6.227
SYSTem:COMMunicate:SERial[:RECeive]:BITS	7 8	6.227
SYSTem:COMMunicate:SERial[:RECeive]:PACE	XON NONE	6.228
SYSTem:COMMunicate:SERial[:RECeive]:PARity[:TYPE]	EVEN ODD NONE	6.228
SYSTem:COMMunicate:SERial[:RECeive]:SBITs	1 2	6.228
SYSTem:DATE	1980 to 2099, 1 to 12, 1 to 31	6.229
SYSTem:DISPlay:FPANel	ON OFF	6.230
SYSTem:DISPlay:UPDate	ON OFF	6.230
SYSTem:ERRor:CLEar:ALL		6.231
SYSTem:ERRor:LIST?		6.231
SYSTem:ERRor?		6.230
SYSTem:FIRMware:UPDate	<path>	6.231
SYSTem:HPCoupling	FSP HP	6.232
SYSTem:IDENtify:FACTory		6.232
SYSTem:IFGain:MODE	NORMal PULSe	6.232
SYSTem:KLOCK	ON OFF	6.233
SYSTem:LANGuage	'SCPI' '71100C' '71200C' '71209A' '8560E' '8561E' '8562E' '8563E' '8564E' '8565E' '8566A' '8566B' '8568A' '8568A_DC' '8568B' '8568B_DC' '8591E' '8594E'	6.233
SYSTem:MSIZe?	MBOard	6.235
SYSTem:PASSword[:CENable]	'password'	6.234
SYSTem:PRESet		6.234
SYSTem:PRESet:COMPAtible	FSP OFF	6.234
SYSTem:RSW:	ON OFF	6.235
SYSTem:SPEaker:VOLume	0 to 1	6.234
SYSTem:TIME	0 to 23, 0 to 59, 0 to 59	6.235
SYSTem:VERSion?		6.235
TRACe[:DATA]	TRACE1 TRACE2 TRACE3 SINGLE PHOLd SCAN STATus FINAL1 FINAL2 FINAL3 LIST SPURious, <block> ABITstream <numeric_value>	6.236
TRACe<1 2>:COPY	TRACE1 TRACE2 TRACE3 , TRACE1 TRACE2 TRACE3	6.240
TRACe<1 2>:FEED:CONTRol<1..3>	ALWays NEVer	6.240
TRACe<1 2>:IMMediate:LEVel?		6.240
TRACe<1 2>:IMMediate:RESult?		6.241
TRACe<1 2>:IQ:AVERage:COUNT	0 .. 32767	6.245
TRACe<1 2>:IQ:AVERage[:STATe]	ON OFF	6.244
TRACe<1 2>:IQ:DATA:FORMat	COMPAtible IQBLock IQPair	6.247
TRACe<1 2>:IQ:DATA:MEMory[:RF]?	<offset samples>, <# of samples>	6.247
TRACe<1 2>:IQ:DATA?		6.245
TRACe<1 2>:IQ:SET	<filter type>, <rbw>, <sample rate>, <trigger source>, <trigger slope>, <pretrigger samples>, <# of samples>	6.249
TRACe<1 2>:IQ:SRATe	15.625 kHz to 32 MHz	6.250
TRACe<1 2>:IQ[:STATe]	ON OFF	6.250
TRACe<1 2>:IQ:SYNChronize[:STATe]	ON OFF	6.251
TRACe<1 2>:POINTs	LIMit, 1 to 10000	6.252
TRIGger<1 2>[:SEQUence]:HOLDoff	-100 to 100s	6.254

Alphabetical List of Remote Commands

Command	Parameter	Page
TRIGger<1 2>[:SEQuence]:HOLDoff:ADJust:AUTO	ON OFF	6.254
TRIGger<1 2>[:SEQuence]:LEVel[:EXternal]	0.5 to +3.5 V	6.253
TRIGger<1 2>[:SEQuence]:LEVel:IFPower	-30 to -10 dBm	6.254
TRIGger<1 2>[:SEQuence]:LEVel:RFPower	-50 to -10 dBm	6.254
TRIGger<1 2>[:SEQuence]:LEVel:VIDeo	0 to 100PCT	6.254
TRIGger<1 2>[:SEQuence]:SLOPe	POSitive NEGative	6.255
TRIGger<1 2>[:SEQuence]:SOURce	IMMediate EXternal VIDeo IFPower RFPower TV AF AM FM PM	6.253
TRIGger<1 2>[:SEQuence]:VIDeo:FIELD:SElect	ALL ODD EVEN	6.255
TRIGger<1 2>[:SEQuence]:VIDeo:FORMat:LPFRame	525 625	6.255
TRIGger<1 2>[:SEQuence]:VIDeo:LINE:NUMBer	<numeric_value>	6.255
TRIGger<1 2>[:SEQuence]:VIDeo:SSIGnal:POLarity	NEGative POSitive	6.256
UNIT<1 2>:POWER	DBM V A W DB PCT UNITLESS DBPW WATT DBUV DBMV VOLT DBUA AMPere DBPT DBUV_M DBUA_M	6.257

7 Remote Control – Programming Examples

7.1 Introduction	7.2
7.2 Basic Programming Steps for the VISA Interface	7.2
7.2.1 Service Request	7.2
7.2.1.1 Initiate Service Request	7.3
7.2.1.2 Waiting for the Arrival of a Service Request	7.3
7.2.1.3 Waiting Without Blocking the Keyboard and Mouse	7.5
7.2.1.4 Service Request Routine	7.6
7.2.1.5 Evaluation of SCPI Status Registers	7.6
7.2.1.6 Evaluation of Event Status Register	7.7
7.3 More Complex Programming Examples	7.8
7.3.1 Using Marker and Delta Marker	7.8
7.3.1.1 Measuring Spurious Emissions	7.8
7.3.1.2 Shape Factor Measurement (Using n dB Down)	7.9
7.3.1.3 Measuring the Third Order Intercept Point	7.10
7.3.1.4 Measuring the AM Modulation Depth	7.12
7.3.2 Limit Lines and Limit Test	7.13
7.3.3 Measuring the Channel and Adjacent Channel Power	7.15
7.3.4 Occupied Bandwidth Measurement	7.17
7.3.5 Time Domain Power Measurement	7.18
7.3.6 Fast Power Measurement on Power Ramps	7.19
7.3.6.1 Power Measurement with Multi-Summary Marker	7.19
7.3.6.2 Multi-Burst Power Measurement	7.22
7.3.7 Fast Level Measurement Using Frequency Lists	7.24
7.3.8 Level Correction of Transducers (Definition of Transducer Factors)	7.26
7.3.9 Measuring the Magnitude and Phase of a Signal (I/Q Data Acquisition)	7.27
7.3.10 Averaging I/Q Data	7.29
7.3.11 Reading and Writing Files	7.30
7.3.11.1 Reading a File from the Instrument	7.30
7.3.11.2 Creating a File on the Instrument	7.31

7.1 Introduction

The following programming examples have a hierarchical structure, i.e. subsequent examples are based on previous ones. It is thus possible to compile very easily an operational program from the modules of the given examples. VISUAL BASIC has been used as programming language. However, the programs can be translated into other languages.



In programming languages as C, C++ or programmes as MATLAB, NI Interactive Control, a backslash starts an escape sequence (e.g. “\n” is used to start a new line). In these programming languages and programs, two backslashes instead of one must be used in remote commands (for an example refer to the Quick Start Guide, chapter “Brief Introduction to Remote Control“.)

Example:

To store instrument settings use: `MMEM:STOR:STAT 1,'D:\\USER\\DATA\\TEST1'`

instead of: `MMEM:STOR:STAT 1,'D:\USER\DATA\TEST1'`

In this chapter, more complex programming examples are given. In the Quick Start Guide, chapter 6, basic steps in remote control programming are provided.

7.2 Basic Programming Steps for the VISA Interface

In this section, all basic programming examples about the topic service request are included:

- [“Initiate Service Request” on page 7.3](#)
- [“Waiting for the Arrival of a Service Request” on page 7.3](#)
- [“Waiting Without Blocking the Keyboard and Mouse” on page 7.5](#)
- [“Service Request Routine” on page 7.6](#)
- [“Evaluation of SCPI Status Registers” on page 7.6](#)
- [“Evaluation of Event Status Register” on page 7.7](#)

Basic examples that explain the programming of the instrument and can serve as a basis to solve more complex programming tasks are provided in the Quick Start Guide, chapter 6.

7.2.1 Service Request

The service request routine requires an extended initialization of the instrument in which the relevant bits of the transition and enable registers are set. In order to use the service request function in conjunction with a National Instruments GPIB driver, the setting "Disable Auto Serial Poll" must be changed to "yes" by means of IBCONF.

7.2.1.1 Initiate Service Request

```

REM ---- Example of initialization of the SRQ in the case of errors -----
PUBLIC SUB SetupSRQ()
status = viWrite(analyzer, "*CLS", 4, retCnt)
        'Reset status reporting system
status = viWrite(analyzer, "*SRE 168", 8, retCnt)
        'Permit service request for STAT:OPER,STAT:QUES and ESR registe
status = viWrite(analyzer, "*ESE 60", 7, retCnt)
        'Set event enable bit for command, execution, device-dependent
        'and query error
status = viWrite(analyzer, "STAT:OPER:ENAB 32767", 20, retCnt)
        'Set OPERation enable bit for all events
status = viWrite(analyzer, "STAT:OPER:PTR 32767", 19, retCnt)
        'Set appropriate OPERation Ptransition bits
status = viWrite(analyzer, "STAT:QUES:ENAB 32767", 20, retCnt)
        'Set questionable enable bits for all events
status = viWrite(analyzer, "STAT:QUES:PTR 32767", 19, retCnt)
        'Set appropriate questionable Ptransition bits
END SUB
REM *****

```

7.2.1.2 Waiting for the Arrival of a Service Request

There are basically two methods of waiting for the arrival of a service request:

Blocking (user inputs not possible)

This method is appropriate if the waiting time until the event to be signalled by an SRQ is short (shorter than the selected time-out), if no response to user inputs is required during the waiting time, and if – as the main criterion – the event is absolutely certain to occur.

Reason:

From the time the WaitSRQ() function is called until the occurrence of the expected event, it does not allow the program to respond to mouse clicks or key entries during the waiting time. Moreover, it causes program abort if the SRQ event does not occur within the predefined time-out period.

The method is, therefore, in many cases not suitable for waiting for measurement results, especially with triggered measurements.

The following function calls are required:

```

status = viEnableEvent(analyzer, VI_EVENT_SERVICE_REQ, VI_QUEUE, VI_NULL)
status = viWaitOnEvent(analyzer, VI_EVENT_SERVICE_REQ, 10000, etype, eevent)
        'Wait for service request
IF (result% = 1) THEN CALL Srq
        'If SRQ is recognized => subroutine for evaluation

```

Non-blocking (user inputs possible)

This method is recommended if the waiting time until the event to be signalled by an SRQ is long (longer than the selected time-out), and user inputs should be possible during the waiting time, or if the event is not certain to occur. This method is, therefore, the preferable choice for waiting for the end of measurements, i.e. the output of results, especially in the case of triggered measurements.

The method necessitates a waiting loop that checks the status of the SRQ line at regular intervals and returns control to the operating system during the time the expected event has not yet occurred. In this way, the system can respond to user inputs (mouse clicks, key entries) during the waiting time.

A query of the VI_ATTR_GPIB_SRQ_STATE attribute can only be sent from the controller, not from the instrument. Therefore, the handle of the controller board is used for this calling of the viGetAttribute attribute.

It is advisable to employ the Hold() auxiliary function, which returns control to the operating system for a selectable waiting time (see section [“Waiting Without Blocking the Keyboard and Mouse” on page 7.5](#)), so enabling user inputs during the waiting time.

```

result% = 0
For i = 1 To 10
    'Abort after max. 10 loop iterations
    Call viGetAttribute(board, VI_ATTR_GPIB_SRQ_STATE, result%)
    'Check service request line
    If (result% <> 0) Then
        CALL Srq
        'If SRQ is recognized => subroutine for evaluation
    Else
        CALL Hold(20)
        'Call hold function with 20 ms waiting time.
        'User inputs are possible.
    Endif
Next i
If result% = 0 Then
    PRINT "Timeout Error; Program aborted"
    'Output error message
    STOP
    'Stop software
Endif

```

7.2.1.3 Waiting Without Blocking the Keyboard and Mouse

A frequent problem with remote control programs using Visual Basic is to insert waiting times without blocking the keyboard and the mouse.

If the program is to respond to user inputs also during a waiting time, control over the program events during this time must be returned to the operating system. In Visual Basic, this is done by calling the *DoEvents* function. This function causes keyboard- or mouse-triggered events to be executed by the associated elements. For example, it allows the operation of buttons and input fields while the user waits for an instrument setting to be completed.

The following programming example describes the *Hold()* function, which returns control to the operating system for the period of the waiting time selectable in milliseconds.

```

Rem *****
Rem The waiting function below expects the transfer of the desired
Rem waiting time in milliseconds. The keyboard and the mouse remain
Rem operative during the waiting period, thus allowing desired elements
Rem to be controlled
REM *****
Public SUB Hold(delayTime As Single)
Start = Timer
        'Save timer count on calling the function
DO While Timer < Start + delayTime / 1000
        'Check timer count
        DoEvents
        'Return control to operating system to enable control of
        desired elements as long as timer has not elapsed
LOOP
END SUB
REM *****

```

The waiting procedure is activated simply by calling *Hold(<Waiting time in milliseconds>)*.

7.2.1.4 Service Request Routine

A service request is processed in the service request routine.

```

REM ----- Service request routine -----
Public SUB Srq()
ON ERROR GOTO noDevice
    'No user existing
Call viReadSTB(analyzer, STB%)
    'Serial poll, read status byte
IF STB% > 0 THEN
    'This instrument has bits set in the STB
    SRQFOUND% = 1
    IF (STB% AND 16) > 0 THEN CALL Outputqueue
    IF (STB% AND 4) > 0 THEN CALL ErrorQueueHandler
    IF (STB% AND 8) > 0 THEN CALL Questionablestatus
    IF (STB% AND 128) > 0 THEN CALL Operationstatus
    IF (STB% AND 32) > 0 THEN CALL Esrread
END IF
noDevice:
END SUB
REM *****

```

Reading out the status event registers, the output buffer and the error/event queue is effected in subroutines.

7.2.1.5 Evaluation of SCPI Status Registers

```

REM ----- Subroutine for evaluating Questionable Status Register -----
Public SUB Questionablestatus()
Ques$ = SPACE$(20)
    'Preallocate blanks to text variable
status = viWrite(analyzer, "STATUS:QUESTIONABLE:EVENT?", 26, retCnt)
status = viRead(analyzer, Ques$, 20, retCnt)
PRINT "Questionable Status: "; Ques$
END SUB
REM *****
REM ----- Subroutine for evaluating Operation Status Register -----
Public SUB Operationstatus()
Oper$ = SPACE$(20)
    'Preallocate blanks to text variable
status = viWrite(analyzer, "STATUS:OPERATION:EVENT?", 23, retCnt)
status = viRead(analyzer, Oper$, 20, retCnt)
PRINT "Operation Status: "; Oper$
END SUB
REM *****

```

7.2.1.6 Evaluation of Event Status Register

```

REM ----- Subroutine for evaluating the Event Status Register -----
Public SUB Esrread()
Esr$ = SPACE$(20)
        'Preallocate blanks to text variable
status = viWrite(analyzer, "*ESR?", 5, retCnt)
        'Read ESR
status = viRead(analyzer, Esr$, 20, retCnt)
IF (VAL(Esr$) AND 1) > 0 THEN PRINT "Operation complete"
IF (VAL(Esr$) AND 2) > 0 THEN PRINT "Request Control"
IF (VAL(Esr$) AND 4) > 0 THEN PRINT "Query Error"
IF (VAL(Esr$) AND 8) > 0 THEN PRINT "Device dependent error"
IF (VAL(Esr$) AND 16) > 0 THEN
    PRINT "Execution Error; Program aborted"
        'Output error message
    STOP
        'Stop software
END IF
IF (VAL(Esr$) AND 32) > 0 THEN
    PRINT "Command Error; Program aborted"
        'Output error message
    STOP
        'Stop software
END IF
IF (VAL(Esr$) AND 64) > 0 THEN PRINT "User request"
IF (VAL(Esr$) AND 128) > 0 THEN PRINT "Power on"
END SUB
REM *****

```

7.3 More Complex Programming Examples

In this section, the more advanced programming examples are included:

- [“Using Marker and Delta Marker” on page 7.8](#)
- [“Limit Lines and Limit Test” on page 7.13](#)
- [“Measuring the Channel and Adjacent Channel Power” on page 7.15](#)
- [“Occupied Bandwidth Measurement” on page 7.17](#)
- [“Time Domain Power Measurement” on page 7.18](#)
- [“Fast Power Measurement on Power Ramps” on page 7.19](#)
- [“Fast Level Measurement Using Frequency Lists” on page 7.24](#)
- [“Level Correction of Transducers \(Definition of Transducer Factors\)” on page 7.26](#)
- [“Measuring the Magnitude and Phase of a Signal \(I/Q Data Acquisition\)” on page 7.27](#)
- [“Reading and Writing Files” on page 7.30](#)

For basic programming examples, refer to section [“Basic Programming Steps for the VISA Interface” on page 7.2](#) and the Quick Start Guide, chapter 6.

7.3.1 Using Marker and Delta Marker

7.3.1.1 Measuring Spurious Emissions

In transmission measurements, it is often necessary to search a large frequency range for unwanted spurious emissions.

This can be done by means of the R&S ESCI's LIST PEAKS function, which finds up to 50 peaks in a preselected frequency range and outputs them as a list. The search range can be defined both in terms of frequency and level, and the number of peaks to be found is selectable as well.

In the following example, the 10 highest peaks are to be found in a preselected frequency range. Only signals >-60 dBm in a range ± 400 kHz about the center frequency are of interest, so the search range is limited accordingly. The signals found are output in the order of ascending frequency.

```

REM *****
Public Sub SpuriousSearch()
powerlist$ = Space$(1000)
freqlist$ = Space$(1000)
countstr$ = Space$(30)
      '----- R&S ESCI default setting -----
CALL SetupInstrument
      'Default setting
status = viWrite(analyzer, "INIT:CONT OFF", 13, retCnt)
      'Single sweep
      '----- Definition of search range -----
status = viWrite(analyzer, "CALC:MARK:X:SLIM:STAT ON", 24, retCnt)
status = viWrite(analyzer, "CALC:MARK:X:SLIM:LEFT 99.6MHz;RIGHT 100.4MHz", 44,
retCnt)

```

```

        'Activate search limit and set to ±400 kHz about center
        frequency
status = viWrite(analyzer, "CALC:THR:STAT ON", 16, retCnt)
status = viWrite(analyzer, "CALC:THR -60DBM", 15, retCnt)
        'Activate threshold and set to -60 dBm
        '----- Activate search for spurious -----
status = viWrite(analyzer, "CALC:MARK:FUNC:FPE:SORT X", 25, retCnt)
        'Sort according to frequency
status = viWrite(analyzer, "INIT;*WAI", 9, retCnt)
        'Perform sweep with sync
status = viWrite(analyzer, "CALC:MARK:FUNC:FPE 10", 21, retCnt)
        'Search for 10 highest peaks
status = viWrite(analyzer, "CALC:MARK:FUNC:FPE:COUN?", 24, retCnt)
        'Call number of peaks, check it,
status = viRead(analyzer, countstr$, 30, retCnt)
        'and read it in
status = viWrite(analyzer, "CALC:MARK:FUNC:FPE:X?", 21, retCnt)
        'Query and read
status = viRead(analyzer, freqlist$, 1000, retCnt)
        'frequency list
status = viWrite(analyzer, "CALC:MARK:FUNC:FPE:Y?", 21, retCnt)
        'Query and read
status = viRead(analyzer, powerlist$, 1000, retCnt)
        'level list
Print "# of spurious: ";countstr$
        'Output number of results
Print "Frequencies: ";freqlist$
        'Output frequency list
Print "Power: ";powerlist$
        'Output level list

END SUB
REM *****

```

7.3.1.2 Shape Factor Measurement (Using n dB Down)

The n-dB-down function of the R&S ESCI is used twice to determine the shape factor of a filter (ratio of bandwidths at 60 dB and 3 dB below the filter maximum).

The following example is again based on a signal with a level of -30 dBm at 100 MHz. The shape factor is determined for the 30 kHz resolution bandwidth. The default setting of the R&S ESCI is used for measurements (SetupInstrument).

```

REM *****
Public Sub ShapeFactor()
        result$ = Space$(100)
        '----- R&S ESCI default setting -----
CALL SetupInstrument
        'Default setting
status = viWrite(analyzer, "INIT:CONT OFF", 13, retCnt)
        'Single sweep

```

```

'----- Set frequency -----
status = viWrite(analyzer, "FREQ:SPAN 1MHz", 14, retCnt)
'Span
status = viWrite(analyzer, "BAND:RES 30kHz", 14, retCnt)
'Resolution bandwidth
status = viWrite(analyzer, "INIT;*WAI", 9, retCnt)
'Perform sweep with sync
'----- Measure 60 dB value -----
status = viWrite(analyzer, "CALC:MARK:PEXC 6DB", 18, retCnt)
'Peak excursion
status = viWrite(analyzer, "CALC:MARK:STAT ON", 17, retCnt)
'Marker1 on
status = viWrite(analyzer, "CALC:MARK:TRAC 1", 16, retCnt)
'Assign marker1 to trace1
status = viWrite(analyzer, "CALC:MARK:MAX", 13, retCnt)
'Set marker1 to 100 MHz
status = viWrite(analyzer, "CALC:MARK:FUNC:NDBD 60dB", 24, retCnt)
'Read out bandwidth measured
status = viWrite(analyzer, "CALC:MARK:FUNC:NDBD:RES?", 24, retCnt)
'at 60 dB
status = viRead(analyzer, result$, 100, retCnt)
result60 = Val(result$)
'----- Measure 3 dB Down value -----
status = viWrite(analyzer, "CALC:MARK:FUNC:NDBD 3dB", 23, retCnt)
'Read out bandwidth measured
status = viWrite(analyzer, "CALC:MARK:FUNC:NDBD:RES?", 24, retCnt)
'at 60 dB
status = viRead(analyzer, result$, 100, retCnt)
result3 = Val(result$)
'----- Read out shape factor-----
Print "Shapefaktor 60dB/3dB: ";result60/result3
END SUB
REM *****

```

7.3.1.3 Measuring the Third Order Intercept Point

The third order intercept point (TOI) is the (virtual) level of two adjacent useful signals at which the intermodulation products of third order have the same level as the useful signals.

The intermodulation product at f_{S2} is obtained by mixing the first harmonic of the useful signal P_{N2} with signal P_{N1} , the intermodulation product at f_{S1} by mixing the first harmonic of the useful signal P_{N1} with signal P_{N2} .

$$f_{S1} = 2 \times f_{n1} - f_{n2} \quad (4)$$

$$f_{S2} = 2 \times f_{n2} - f_{n1} \quad (5)$$

The following example is based on two adjacent signals with a level of -30 dBm at 100 MHz and 110 MHz. The intermodulation products lie at 90 MHz and 120 MHz according to the above formula. The frequency is set so that the examined mixture products are displayed in the diagram. Otherwise, the default setting of the R&S ESCI is used for measurements (SetupInstrument).

```

REM *****
Public Sub TOI()
result$ = Space$(100)
      '----- R&S ESCI default setting -----
CALL SetupStatusReg
      'Set status registers
status = viWrite(analyzer, "*RST", 4, retCnt)
      'Reset instrument
status = viWrite(analyzer, "INST:SEL SAN", 12, retCnt)
      'Change into analyzer mode
status = viWrite(analyzer, "INIT:CONT OFF", 13, retCnt)
      'Single sweep
status = viWrite(analyzer, "SYST:DISP:UPD ON", 16, retCnt)
      'ON: display on
      'OFF: off
      '----- Set frequency -----
status = viWrite(analyzer, "FREQ:START 85MHz;STOP 125 MHz", 29, retCnt)
      'Span
      '----- Set level -----
status = viWrite(analyzer, "DISP:WIND:TRAC:Y:RLEV -20dBm", 28, retCnt)
      'Reference level
status = viWrite(analyzer, "INIT;*WAI", 4, retCnt)
      'Perform sweep with sync
      '----- TOI measurement -----
status = viWrite(analyzer, "CALC:MARK:PEXC 6DB", 18, retCnt)
      'Peak excursion
status = viWrite(analyzer, "CALC:MARK:FUNC:TOI ON", 21, retCnt)
      'Switch on TOI measurement
status = viWrite(analyzer, "CALC:MARK:FUNC:TOI:RES?", 23, retCnt)
      'and read out results
status = viRead(analyzer, result$, 100, retCnt)
      '----- Read out result -----
Print "TOI [dBm]: "; result$
END SUB
REM *****

```

7.3.1.4 Measuring the AM Modulation Depth

The example below is based on an AM-modulated signal at 100 MHz with the following characteristics:

- Carrier signal level: –30 dBm
- AF frequency: 100 kHz
- Modulation depth: 50%

The default setting of the R&S ESCI can be used for the measurements described below (SetupInstrument).

```

REM *****
Public Sub AMMod()
result$ = Space$(100)
CALL SetupInstrument
    'Default setting
    '----- Peak search -----
status = viWrite(analyzer, "INIT:CONT OFF", 13, retCnt)
    'Single sweep
status = viWrite(analyzer, "INIT;*WAI", 9, retCnt)
    'Perform sweep with sync
status = viWrite(analyzer, "CALC:MARK:PEXC 6DB", 18, retCnt)
    'Peak excursion
status = viWrite(analyzer, "CALC:MARK:STAT ON", 17, retCnt)
    'Marker 1 on
status = viWrite(analyzer, "CALC:MARK:TRAC 1", 16, retCnt)
    'Assign marker1 to trace1
    '----- Measure modulation depth-----
status = viWrite(analyzer, "CALC:MARK:MAX;FUNC:MDEP ON", 26, retCnt)
    'Marker to Peak;
status = viWrite(analyzer, "CALC:MARK:FUNC:MDEP:RES?", 24, retCnt)
    'Measure mod. depth
status = viRead(analyzer, result$, 100, retCnt)
    'Read out result
    '----- Read out result -----
Print "AM Mod Depth [%]: "; result$
END SUB
REM *****

```

7.3.2 Limit Lines and Limit Test

The example below shows the definition and use of a new limit line 5 for trace 1 on screen A and trace 2 on screen B with the following characteristics:

- Upper limit line
- Absolute x-axis in the frequency range
- 5 reference values: 120 MHz/-70 dB, 126 MHz/-40 dB, 127 MHz/-40 dB, 128 MHz/-10 dB, 129 MHz/-40 dB, 130 MHz/-40 dB, 136 MHz/-70 dB
- Relative y-axis with unit dB
- Absolute threshold at -75 dBm
- No margin

The signal of the integrated calibration source (128 MHz, -30 dBm) is used to check the limit test.

```

REM *****
Public Sub LimitLine()
result$ = Space$(100)
    '----- R&S ESCI default setting -----
    CALL SetupInstrument
    'Default setting
status = viWrite(analyzer, "FREQUENCY:CENTER 128MHz;Span 10MHz", 34, retCnt)
    'Span
status = viWrite(analyzer, "Diag:Serv:Inp Cal;CSO -30dBm", 28, retCnt)
    'Cal signal on
    '----- Definition of limit lines -----
status = viWrite(analyzer, "CALC:LIM5:NAME 'TEST1'", 22, retCnt)
    'Define name
status = viWrite(analyzer, "CALC:LIM5:COMM 'Upper limit'", 28, retCnt)
    'Define comment
status = viWrite(analyzer, "CALC1:LIM5:TRAC 1", 17, retCnt)
    'Assign trace in screen A
status = viWrite(analyzer, "CALC2:LIM5:TRAC 2", 17, retCnt)
    'Assign trace in screen B
status = viWrite(analyzer, "CALC:LIM5:CONT:DOM FREQ", 23, retCnt)
    'Define x-axis range
status = viWrite(analyzer, "CALC:LIM5:CONT:MODE ABS", 23, retCnt)
    'Define x-axis scaling
status = viWrite(analyzer, "CALC:LIM5:UNIT DB", 17, retCnt)
    'Define y-axis unit
status = viWrite(analyzer, "CALC:LIM5:UPP:MODE REL", 22, retCnt)
    'Define y-axis scaling

```

```

                '----- Definition of data points and threshold -----
xlimit$ = "CALC:LIM5:CONT 120MHZ,126MHZ,127MHZ,128MHZ,129MHZ,130MHZ,136MHZ"
status = viWrite(analyzer, xlimit$, 63, retCnt) 'Set values for x-axis
status = viWrite(analyzer, "CALC:LIM5:UPP -70,-40,-40,-20,-40,-40,-70", 41,
retCnt)
                'Set values for y-axis
status = viWrite(analyzer, "CALC:LIM5:UPP:THR -75DBM", 24, retCnt)
                'Set y threshold (only possible for relative y-axis)
                'A margin or an x /y offset can be defined here.
                '----- Activate and evaluate the limit line in screen A --
status = viWrite(analyzer, "CALC1:LIM5:UPP:STAT ON", 22, retCnt)
                'Activate line 5 in screen A
status = viWrite(analyzer, "CALC1:LIM5:STAT ON", 18, retCnt)
                'Activate limit check in screen A
status = viWrite(analyzer, "INIT;*WAI", 9, retCnt)
                'Perform sweep with sync
status = viWrite(analyzer, "CALC1:LIM5:FAIL?", 16, retCnt)
                'Query result of limit check
status = viRead(analyzer, result$, 100, retCnt)
                'Result: 1 (= FAIL)
                '----- Read out result -----
Print "Limit Result Line 5: "; result$
                '- Evaluate limit line in screen A by means of status register -
status = viWrite(analyzer, "*CLS", 4, retCnt)
                'Reset status register
                '----- Measure -----
status = viWrite(analyzer, "INIT;*OPC?", 4, retCnt)
                'Perform sweep with sync
status = viRead(analyzer, result$, 100, retCnt)
                'Wait for service request
status = Val(result$)
                '----- Read out result -----
IF (status% = 1) THEN
    status = viWrite(analyzer, "STAT:QUES:LIM1:COND?", 20, retCnt)
                'Read out STAT:QUES:LIMit register
    status = viRead(analyzer, result$, 100, retCnt)
                'Read out result
    IF ((Val(result$) And 16) <> 0) THEN
        Print "Limit5 failed"
    ELSE
        Print "Limit5 passed"
    END IF
END IF
END SUB
REM *****

```

7.3.3 Measuring the Channel and Adjacent Channel Power

In the following example, the channel and adjacent channel power is first measured on a signal with a level of 0 dBm at 800 MHz to IS95. Then the channel and adjacent channel power is measured on a GSM signal at 935.2 MHz with fast ACP measurement (FAST ACP).

In addition, the limit test is activated.

```

REM *****
Public Sub ACP()
    result$ = Space$(100)
'----- R&S ESCI default setting -----
CALL SetupStatusReg
    'Set status register
status = viWrite(analyzer, "*RST", 4, retCnt)
    'Reset instrument
status = viWrite(analyzer, "INST:SEL SAN", 12, retCnt)
    'Change into analyzer mode
status = viWrite(analyzer, "INIT:CONT OFF", 13, retCnt)
    'Single sweep
status = viWrite(analyzer, "SYST:DISP:UPD ON", 16, retCnt)
    'ON: display on
    'OFF: off
'----- Set frequency -----
status = viWrite(analyzer, "FREQ:CENT 800MHz", 16, retCnt) 'Set frequency
'----- Set level -----
status = viWrite(analyzer, "DISP:WIND:TRAC:Y:RLEV 10dBm", 27, retCnt)
    'Reference level
'----- Example 1: Configure CP/ACP for CDMA -----
status = viWrite(analyzer, "CALC2:MARK:FUNC:POW:SEL ACP", 27, retCnt)
    'ACP measurement on
status = viWrite(analyzer, "CALC:MARK:FUNC:POW:PRES F8CDMA", 30, retCnt)
    'Select CDMA800 FWD
status = viWrite(analyzer, "SENS:POW:ACH:ACP 2", 18, retCnt)
    'Select 2 adjacent channels
status = viWrite(analyzer, "SENS:POW:ACH:PRES ACP", 21, retCnt)
    'Optimize settings
status = viWrite(analyzer, "SENS:POW:ACH:PRES:RLEV;*WAI", 27, retCnt)
    'Optimize reference level
status = viWrite(analyzer, "SENS:POW:ACH:MODE ABS", 21, retCnt)
    'Absolute measurement
status = viWrite(analyzer, "SENS:POW:HSP ON", 15, retCnt)
    'Fast ACP measurement
'----- Perform measurement and query results -----
status = viWrite(analyzer, "INIT;*WAI", 9, retCnt)
    'Perform sweep with sync
status = viWrite(analyzer, "CALC2:MARK:FUNC:POW:RES? ACP", 28, retCnt)
    'Query result
status = viRead(analyzer, result$, 100, retCnt)

```

```

'----- Read out result -----
Print "Result (CP, ACP low, ACP up, Alt low, Alt up): "
Print result$
'----- Example 2: Configure CP/ACP manually for GSM -----
result$ = Space$(100)
status = viWrite(analyzer, "FREQ:CENT 935.2MHz", 18, retCnt)
        'Set frequency
status = viWrite(analyzer, "CALC:MARK:FUNC:POW:SEL ACP", 26, retCnt)
        'ACP measurement on
status = viWrite(analyzer, "SENS:POW:ACH:ACP 1", 18, retCnt)
        '1 adjacent channel
status = viWrite(analyzer, "SENS:POW:ACH:BAND 200KHZ", 24, retCnt)
        'Channel bandw. 200 kHz
status = viWrite(analyzer, "SENS:POW:ACH:BAND:ACH 200KHZ", 28, retCnt)
        'Adjacent channel bandwidth 200 kHz
status = viWrite(analyzer, "SENS:POW:ACH:SPAC 200KHZ", 24, retCnt)
        'Channel spacing 200 kHz
status = viWrite(analyzer, "SENS:POW:ACH:PRES ACP", 21, retCnt)
        'Optimize settings
status = viWrite(analyzer, "SENS:POW:ACH:PRES:RLEV;*WAI", 27, retCnt)
        'Optimize reference level
status = viWrite(analyzer, "SENS:POW:ACH:MODE ABS", 21, retCnt)
        'Absolute measurement
'----- Start measurement and query result -----
status = viWrite(analyzer, "INIT;*WAI", 9, retCnt)
        'Perform sweep with sync
status = viWrite(analyzer, "CALC:MARK:FUNC:POW:RES? ACP", 27, retCnt)
        'Query result
status = viRead(analyzer, result$, 100, retCnt)
'----- Read out result -----
Print "Result (CP, ACP low, ACP up): "
Print result$
'----- Active limit check -----
result$ = Space$(100)
status = viWrite(analyzer, "CALC:LIM:ACP:ACH 30DB, 30DB", 27, retCnt)
        'Set relative limit
status = viWrite(analyzer, "CALC:LIM:ACP:ACH:ABS -35DBM,-35DBM", 34, retCnt)
        'Set absolute limit
status = viWrite(analyzer, "CALC:LIM:ACP:ACH:STAT ON", 24, retCnt)
        'Rel. limit check on
status = viWrite(analyzer, "CALC:LIM:ACP:ACH:ABS:STAT ON", 28, retCnt)
        'Abs. limit check on
status = viWrite(analyzer, "CALC:LIM:ACP ON", 15, retCnt)
        'Limit check on

```

```
'----- Start measurement and query result -----
status = viWrite(analyzer, "INIT;*WAI", 9, retCnt)
        'Perform sweep with sync
status = viWrite(analyzer, "CALC:LIM:ACP:ACH:RES?", 21, retCnt)
        'Query result of
status = viRead(analyzer, result$, 100, retCnt)
        'limit check
'----- Read out result -----
Print "Result Limit Check: "; result$
END SUB
REM *****
```

7.3.4 Occupied Bandwidth Measurement

In the following example, the bandwidth is to be found in which 95% of the power of a GSM signal is contained. Signal frequency is 935,2 MHz; channel bandwidth is 200 kHz.

```
REM *****
Public Sub OBW()
result$ = Space$(100)
'----- R&S ESCI default setting -----
CALL SetupStatusReg
        'Set status register
status = viWrite(analyzer, "*RST", 4, retCnt)
        'Reset instrument
status = viWrite(analyzer, "INST:SEL SAN", 12, retCnt)
        'Change into analyzer mode
status = viWrite(analyzer, "INIT:CONT OFF", 13, retCnt)
        'Single sweep
status = viWrite(analyzer, "SYST:DISP:UPD ON", 16, retCnt)
        'ON: display on
        'OFF: off
'----- Configure R&S ESCI for OBW for GSM -----
status = viWrite(analyzer, "FREQ:CENT 935.2MHz", 18, retCnt)
        'Set frequency
status = viWrite(analyzer, "CALC:MARK:FUNC:POW:SEL OBW", 26, retCnt)
        'OBW measurement on
status = viWrite(analyzer, "SENS:POW:ACH:BAND 200KHZ", 24, retCnt)
        'Channel bandw. 200 kHz
status = viWrite(analyzer, "SENS:POW:BWID 95PCT", 19, retCnt)
        'Percentage of power
status = viWrite(analyzer, "SENS:POW:ACH:PRES OBW", 21, retCnt)
        'Set frequency and
status = viWrite(analyzer, "SENS:POW:ACH:PRES:RLEV;*WAI", 27, retCnt)
        'Optimize reference level
status = viWrite(analyzer, "SENS:POW:NCOR OFF", 17, retCnt)
        'Noise correction
```

```

        'OFF: switch off
        'ON: switch on
'----- Perform measurement and query results -----
status = viWrite(analyzer, "INIT;*WAI", 9, retCnt)
        'Perform sweep with sync
status = viWrite(analyzer, "CALC:MARK:FUNC:POW:RES? OBW", 27, retCnt)
        'Query result
status = viRead(analyzer, result$, 100, retCnt)
Print result$
END SUB
REM *****

```

7.3.5 Time Domain Power Measurement

In the following example, the mean carrier power of a signal with 300 kHz bandwidth at 100 MHz is to be determined. In addition, the peak power, the rms value and the standard deviation are measured. To do this, the time-domain-power measurement functions are used.

```

REM *****
Public Sub TimeDomainPower()
result$ = Space$(100)
        '----- R&S ESCI default setting -----
CALL SetupStatusReg
        'Set status register
status = viWrite(analyzer, "*RST", 4, retCnt)
        'Reset instrument
status = viWrite(analyzer, "INST:SEL SAN", 12, retCnt)
        'Change into analyzer mode
status = viWrite(analyzer, "INIT:CONT OFF", 13, retCnt)
        'Single sweep
status = viWrite(analyzer, "SYST:DISP:UPD ON", 16, retCnt)
        'ON: display on
        'OFF: off
        '---- Configure R&S ESCI for time domain power measurement ---
status = viWrite(analyzer, "FREQ:CENT 100MHz;SPAN 0Hz", 25, retCnt)
        'Set frequency
status = viWrite(analyzer, "BAND:RES 300kHz", 15, retCnt)
        'Resolution bandwidth
status = viWrite(analyzer, "SWE:TIME 200US", 14, retCnt)
        'Sweep time
status = viWrite(analyzer, "CALC:MARK:FUNC:SUMM:PPE ON", 26, retCnt)
        'Peak measurement on
status = viWrite(analyzer, "CALC:MARK:FUNC:SUMM:MEAN ON", 27, retCnt)
        'Mean measurement on
status = viWrite(analyzer, "CALC:MARK:FUNC:SUMM:RMS ON", 26, retCnt)
        'RMS measurement on
status = viWrite(analyzer, "CALC:MARK:FUNC:SUMM:SDEV ON", 27, retCnt)
        'Standard deviation on

```



```

                '----- Perform measurement and query results -----
status = viWrite(analyzer, "INIT;*WAI", 9, retCnt)
                'Perform sweep with sync
                'Query results:
query$ =          " CALC:MARK:FUNC:SUMM:PPE:RES?;"
                'Peak measurement
query$ = query$ + ":CALC:MARK:FUNC:SUMM:MEAN:RES?;"
                'Mean measurement
query$ = query$ + ":CALC:MARK:FUNC:SUMM:RMS:RES?;"
                'RMS measurement
query$ = query$ + ":CALC:MARK:FUNC:SUMM:SDEV:RES?"
                'Standard deviation
status = viWrite(analyzer, query$, 120, retCnt)
status = viRead(analyzer, result$, 100, retCnt)
Print result$
END SUB
REM *****

```

7.3.6 Fast Power Measurement on Power Ramps

A frequent task in mobile radio tests is measurement of a DUT at various power control levels at the highest possible speed. The R&S ESCI offers two test functions for this task, which can be used depending on the signal characteristics.

In the following, the two methods are presented by means of two examples.

7.3.6.1 Power Measurement with Multi-Summary Marker

The multi-summary marker function is suitable for measuring the power of a sequence of pulses with the following characteristics:

- The pulses occur at identical time intervals, which is typical of GSM transmission in slots, for example.
- The level of the first signal is reliably above threshold.
- The subsequent pulses may have any levels.

The function uses the first pulse as a trigger signal. The power of the subsequent pulses is determined exclusively via the timing pattern selected for the pulse sequence. The function is, therefore, suitable for adjustments where the DUT output power varies considerably and is not reliably above the trigger threshold.

The measurement accuracy is determined by the ratio of pulse duration to total measurement time; this should not be below 1:50.

The function always uses TRACE 1 of the selected screen.

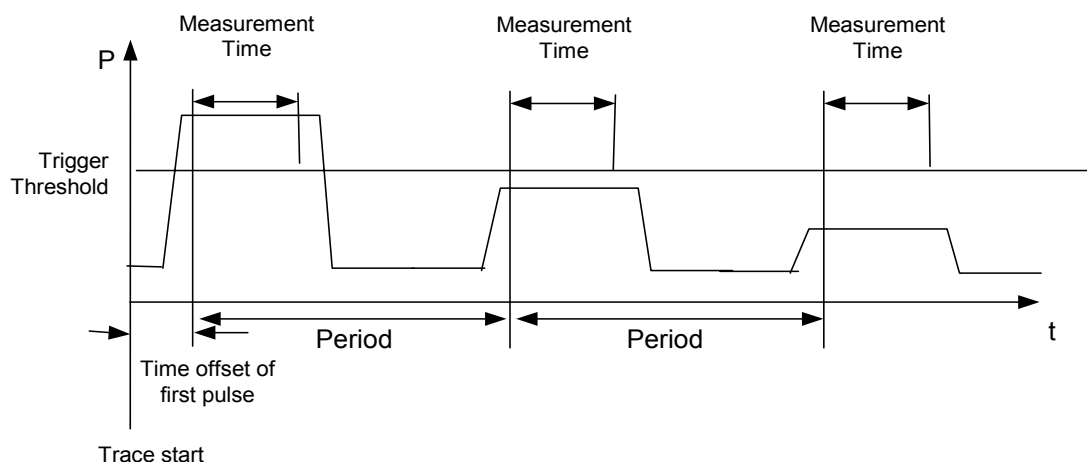

Fig. 7.1 Block diagram illustrating signal processing by the R&S ESCI

In the example below, a sequence of 8 pulses is measured with an offset of 50 μs of the first pulse, 450 μs measurement time/pulse and 576.9 μs pulse period.

```

REM *****
Public Sub MultiSumMarker()
result$ = Space$(200)
        '----- R&S ESCI default setting-----
CALL SetupStatusReg
        'Configure status register
status = viWrite(analyzer, "*RST", 4, retCnt)
        'Reset instrument
status = viWrite(analyzer, "INST:SEL SAN", 12, retCnt)
        'Change into analyzer mode
status = viWrite(analyzer, "INIT:CONT OFF", 13, retCnt)
        'Single sweep mode
status = viWrite(analyzer, "SYST:DISP:UPD ON", 16, retCnt)
        'ON: switch display on
        'OFF: switch display off
        '-- Configure R&S ESCI for power measurement in time domain --
status = viWrite(analyzer, "FREQ:CENT 935.2MHz;SPAN 0Hz", 27, retCnt)
        'Frequency setting
status = viWrite(analyzer, "DISP:WIND:TRAC:Y:RLEV 10dBm", 27, retCnt)
        'Set reference level to 10 dB
status = viWrite(analyzer, "INP:ATT 30 dB", 13, retCnt)
        'Set input attenuation to 30 dB
status = viWrite(analyzer, "BAND:RES 1MHz;VID 3MHz", 22, retCnt)
        'Bandwidth setting
status = viWrite(analyzer, "DET RMS", 7, retCnt)
        'Select RMS detector
status = viWrite(analyzer, "TRIG:SOUR VID", 13, retCnt)
        'Trigger source: video
status = viWrite(analyzer, "TRIG:LEV:VID 50 PCT", 19, retCnt)

```

```
'Trigger threshold: 50%
status = viWrite(analyzer, "SWE:TIME 50ms", 13, retCnt)
'Sweep time ≥ 1 frame
'----- Perform measurement and query results -----
status = viWrite(analyzer, "INIT;*WAI", 9, retCnt)
'Perform sweep with sync
'Query results:
cmd$ = "CALC:MARK:FUNC:MSUM? "
cmd$ = cmd$ + "50US,"
'Offset of first pulse
cmd$ = cmd$ + "450US,"
'Measurement time
cmd$ = cmd$ + "576.9US,"
'Pulse period
cmd$ = cmd$ + "8"
'Number of bursts
status = viWrite(analyzer, cmd$, 41, retCnt)
status = viRead(analyzer, result$, 100, retCnt)
'Read results
Print result$
END SUB
REM *****
```

7.3.6.2 Multi-Burst Power Measurement

The multi-burst power measurement function is suitable for measuring the power of a sequence of pulses with the following characteristics:

- The pulses occur at variable time intervals.
- The levels of all pulses of the sequence are reliably above the trigger threshold, or an external trigger signal is used.

The function requires one trigger event per pulse. This means that if the video trigger or the IF power trigger is used, the levels of all pulses must be above the trigger threshold.

The function is, therefore, particularly suitable for re-measuring DUTs already adjusted and whose output power is within the specified range. The measurement is optimized for minimum overhead relative to the actual measurement time.

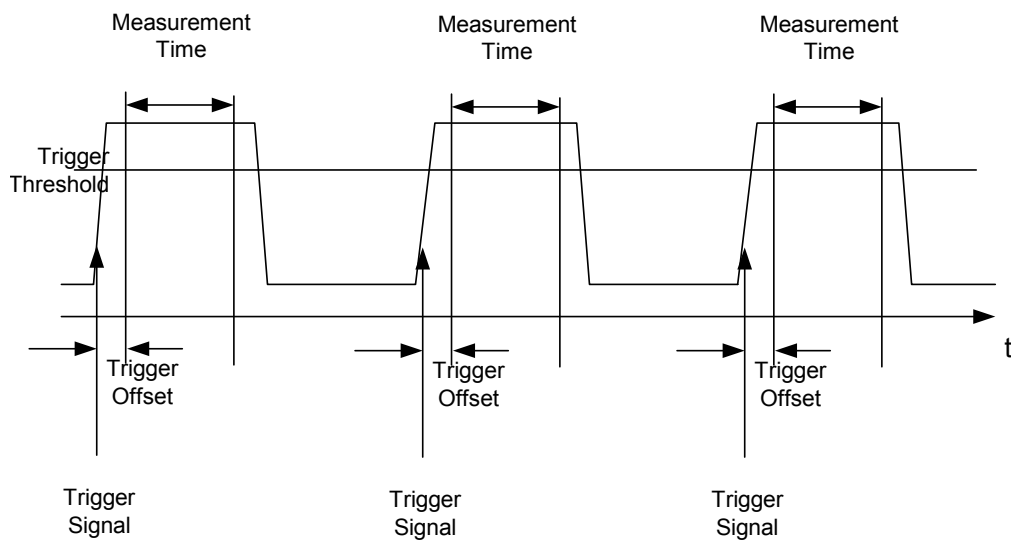

Fig. 7.2 Block diagram illustrating signal processing by the R&S ESCI

Either the root-mean-square power or the peak power is measured, depending on whether the RMS detector or the PEAK detector is selected. The function always uses TRACE 1 of the selected screen.

The following parameters are to be set for this measurement:

- Analyzer frequency
- Resolution bandwidth
- Measurement time per single pulse
- Trigger source
- Trigger threshold
- Trigger offset
- Type of power measurement (PEAK, MEAN)
- Number of pulses to be measured

During the measurement, each pulse is mapped into a pixel of the screen, i.e. any change of the trace can be detected only at the left-hand edge of the screen. Maximum measurement speed is as usual achieved with the display switched off.

In the example below, a GSM pulse sequence of 8 pulses is measured with 5 μ s trigger offset, 434 μ s measurement time/pulse, video trigger with 50% trigger threshold, and peak detection:

```

REM *****
Public Sub MultiBurstPower()
result$ = Space$(200)
      '----- R&S ESCI default setting -----
CALL SetupStatusReg
      'Configure status register
status = viWrite(analyzer, "*RST", 4, retCnt)
      'Reset instrument
status = viWrite(analyzer, "INST:SEL SAN", 12, retCnt)
      'Change into analyzer mode
status = viWrite(analyzer, "INIT:CONT OFF", 13, retCnt)
      'Single sweep mode
status = viWrite(analyzer, "SYST:DISP:UPD OFF", 17, retCnt)
      'OFF: display off
      '----- Perform measurement and query results -----
cmd$ = "MPOW? "
cmd$ = cmd$ + "935.2 MHZ,"
      'Center frequency
cmd$ = cmd$ + "1MHZ,"
      'Resolution bandwidth
cmd$ = cmd$ + "434US,"
      'Measurement time
cmd$ = cmd$ + "VID,"
      'Trigger source
cmd$ = cmd$ + "50PCT,"
      'Trigger threshold
cmd$ = cmd$ + "1US,"
      'Trigger offset, must be > 125 ns
cmd$ = cmd$ + "PEAK,"
      'Peak detector
cmd$ = cmd$ + "8"
      'Number of bursts
status = viWrite(analyzer, cmd$, 47, retCnt)
status = viRead(analyzer, result$, 100, retCnt)
      'Read results
Print result$
END SUB
REM *****

```

7.3.7 Fast Level Measurement Using Frequency Lists

A typical task for the R&S ESCI is power measurement at a number of frequency points, e.g. at multiples of the fundamental (harmonics measurement), or at frequencies defined by a mobile radio standard (e.g. spectrum due to transients at ± 200 kHz, ± 400 kHz, etc. about the carrier frequency of a GSM signal). In many cases, different level and/or bandwidth settings are required for the different frequency points to match the channel spacing and meet the requirements of dynamic range.

Especially for this application, the R&S ESCI offers a number of remote-control functions (commands available in SENSE:LIST subsystem) that allow level measurement based on a frequency list with different instrument settings assigned to different frequencies. Not only the frequency list can be programmed, but also the measurement types (PEAK, RMS, AVG) to be performed simultaneously can be selected.

The example below describes a harmonics measurement on a dual-band amplifier. The harmonics level in general decreases as the frequency increases. To boost measurement sensitivity, therefore, the reference level is lowered by 10 dB from the third harmonic.

The following settings are used:

- Reference level: 10.00 dBm up to 2nd harmonic, 0 dBm from 3rd harmonic
- RF attenuation: 20 dB
- Electronic attenuation: 0 dB
- RBW: 1 MHz
- VBW: 3 MHz
- Filter type: NORMal
- Measurement time: 300 μ s
- Trigger delay: 100 μ s
- Trigger: video, 45%

Frequency	Type
935.2 MHz	GSM 900 fundamental
1805.2 MHz	GSM 1800 fundamental
1870.4 MHz	GSM 900 2nd harmonic
2805.6 MHz	GSM 900 3rd harmonic
3610.4 MHz	GSM 1800 2nd harmonic
3740.8 MHz	GSM 900 4th harmonic
5815.6 MHz	GSM 1800 3rd Harmonic

The frequencies are selected in ascending order to minimize system-inherent waiting times resulting from frequency changes.

At each frequency point the peak power and the rms power are measured. The peak power and the rms power values are stored alternately in the results memory.

```

REM *****
Public Sub FrequencyList()
result$ = Space$(500)
        '----- R&S ESCI default setting -----
CALL SetupStatusReg
        'Configure status register
status = viWrite(analyzer, "*RST", 4, retCnt)
        'Reset instrument
status = viWrite(analyzer, "INST:SEL SAN", 12, retCnt)
        'Change into analyzer mode
status = viWrite(analyzer, "INIT:CONT OFF", 13, retCnt)
        'Single sweep mode
status = viWrite(analyzer, "SYST:DISP:UPD OFF", 17, retCnt)
        'Display off
        '-- Configure R&S ESCI for power measurement based on frequency
        list ---
status = viWrite(analyzer, "TRIG:LEV:VID 45PCT", 18, retCnt)
        'Video trigger threshold
status = viWrite(analyzer, "LIST:POWER:SET ON,ON,OFF,VID,POS,100us,0", 40,
retCnt)
        '----- Perform measurement and query results -----
cmd$ = "LIST:POWer? "
cmd$ = cmd$ + "935.2MHZ,10dBm,20dB,OFF,NORM,1MHz,3MHz,300us,0,"
cmd$ = cmd$ + "1805.2MHZ,10dBm,20dB,OFF,NORM,1MHz,3MHz,300us,0,"
cmd$ = cmd$ + "1870.4MHZ,10dBm,20dB,OFF,NORM,1MHz,3MHz,300us,0,"
cmd$ = cmd$ + "2805.6MHZ,0dBm,20dB,OFF,NORM,1MHz,3MHz,300us,0,"
cmd$ = cmd$ + "3610.4MHZ,10dBm,20dB,OFF,NORM,1MHz,3MHz,300us,0,"
cmd$ = cmd$ + "3740.8MHZ,0dBm,20dB,OFF,NORM,1MHz,3MHz,300us,0,"
cmd$ = cmd$ + "5815.6MHZ,0dBm,20dB,OFF,NORM,1MHz,3MHz,300us,0"
status = viWrite(analyzer, cmd$, 343, retCnt)
status = viRead(analyzer, result$, 100, retCnt)
Print result$
END SUB
REM *****

```

7.3.8 Level Correction of Transducers (Definition of Transducer Factors)

In more complex test systems, the frequency response of the test setup must be taken into account in all power measurements to avoid any measurement errors being introduced from sources other than the DUT.

The R&S ESCI offers the possibility of defining a frequency-dependent attenuation correction factor (transducer factor).

In the example below, a factor with the following characteristics is defined:

Name: Transtest
 Unit: dB
 Scaling: lin
 Comment: simulated cable correction

Frequency	Level
10 MHz	0 dB
100 MHz	3 dB
1 GHz	7 dB
3 GHz	10 dB

The factor is defined and can be activated as required.

```

REM *****
Public Sub TransducerFactor()
    '----- Define transducer factor -----
    status = viWrite(analyzer, "CORR:TRAN:SEL 'TRANSTEST'", 25, retCnt)
    'Define "Transtest" transducer factor
    status = viWrite(analyzer, "CORR:TRAN:UNIT 'DB'", 19, retCnt)
    'Unit 'dB'
    status = viWrite(analyzer, "CORR:TRAN:SCAL LIN", 18, retCnt)
    'Linear frequency axis
    status = viWrite(analyzer, "CORR:TRAN:COMM 'Simulated cable correction'", 43,
    retCnt)
    cmd$ = "CORR:TRAN:DATA "
    'Enter frequency and level
    cmd$ = cmd$ + "10MHz, 0,"
    'values. Level values without unit!
    cmd$ = cmd$ + "100MHz, 3,"
    cmd$ = cmd$ + "1GHz, 7,"
    cmd$ = cmd$ + "3GHz, 10"
    status = viWrite(analyzer, cmd$, 50, retCnt)
    'Enter frequency and level values
    '----- Activate transducer -----
    status = viWrite(analyzer, "CORR:TRAN:STAT ON", 17, retCnt)
    'Activate transducer factor
END SUB
REM *****
  
```

7.3.9 Measuring the Magnitude and Phase of a Signal (I/Q Data Acquisition)

Due to the R&S ESCI's internal architecture, it is capable of measuring and outputting the magnitude and phase of a signal in addition to its power values. This opens up a variety of possibilities for more in-depth analysis (FFT, demodulation, etc.).

For details on signal processing and the relation between sampling rate and maximum bandwidth refer to chapter 6, section "TRACe:IQ Subsystem" on page 6.242.

The following maximum bandwidths are possible in this measurement depending on the selected sampling rate:

The following example shows the steps necessary to collect data at a predefined sampling rate and read it from the I/Q memory.

Data is output in the form of voltage values referring to the analyzer input.

Data can be read in binary or ASCII format.

In binary format, the length information carried in the message header is evaluated and used for calculating the x-axis values.

In ASCII format, only a list of voltage values is output.

Binary data is read in three steps:

1. The number of digits carrying the length information is read.
2. The length information itself is read.
3. The trace data is read.

This procedure is necessary with programming languages like Visual Basic which support only structures of identical data types (arrays), whereas the binary data format uses different data types in the header and the data section.



The arrays for measured data are dimensioned in such a way that they can accommodate the I/Q data of the R&S ESCI (2 * 128 k * 4 byte).

```

---REM *****
Public Sub ReadIQData ()
'----- Create variables -----
Dim IData(131072) As Single
    'Buffer for floating-point I data (= 128*1024 bytes)
Dim QData(131072) As Single
    'Buffer for floating-point Q data (= 128*1024 bytes)
    'Note:
    'Visual Basic cannot read in data volumes larger than 128k
    words!
Dim digits As Byte
    'No. of digits as length
Dim IQBytes As Long
    'Length of trace data in bytes
Dim IQValues As Long
    'No. of meas. values in buffer
asciiResult$ = Space$(6553600) 'Buffer for ASCII I/Q data

```

```

        '(= 25*2*1024 bytes)
result$ = Space$(100)
        'Buffer for simple results
'----- R&S ESCI default setting -----
CALL SetupInstrument
        'Default setting
status = viWrite(analyzer, "TRAC:IQ:STAT ON", 15, retCnt)
        'Activate I/Q data acquisition mode; must be done before
        TRAC:IQ:SET !
        'Select number of test points (= 128 * 1024 - 512) at RBW
        10 MHz, sample rate 32 MHz, trigger free run, pos. trigger edge
        and 0 s trigger delay.
status = viWrite(analyzer, "TRAC:IQ:SET NORM,10MHz,32MHz,IMM,POS,0,130560",
45, retCnt)
'----- Read-out in binary format-----
status = viWrite(analyzer, "FORMAT REAL,32", 14, retCnt)
        'Set binary format
status = viWrite(analyzer, "TRAC:IQ:DATA?", 13, retCnt)
        'Measure + read out I/Q data
status = viRead(analyzer, result$, 2, retCnt)
        'Read and store length for
digits = Val(Mid$(result$, 2, 1))
        'number of digits
result$ = Space$(100)
        'Re-initialize buffer
status = viRead(analyzer, result$, digits, retCnt)
        'Read and store length
IQBytes = Val(Left$(result$, digits))
IQBytes = IQBytes / 2
        'Divide no. per buffer in half
status = viRead32(analyzer, IData(0), IQBytes, retCnt)
        'Read I data in buffer
status = viRead32(analyzer, QData(0), IQBytes, retCnt)
        'Read Q data in buffer
status = viRead(analyzer, result$, 1, retCnt)
        'Read in end character <NL>
'----- Output of binary data as frequency/level pair -----
IQValues = IQBytes/4
        'Single Precision = 4 Bytes
For i = 0 To IQValues - 1
    Print "I-Value["; i; "] = "; IData(i)
    Print "Q-Value["; i; "] = "; QData(i)
Next i
'----- Read-out in ASCII-Format -----
status = viWrite(analyzer, "FORMAT ASCII", 12, retCnt)
        'Set ASCII format
status = viWrite(analyzer, "TRAC:IQ:DATA?", 13, retCnt)
        'Re-measure and read out I/Q data

```

```

status = viRead(analyzer, result$, 6553600, retCnt)
status = viWrite(analyzer, "TRAC:IQ:STAT OFF", 16, retCnt)
           'Stop I/Q data acquisition mode if no further measurements are
           to be done

END SUB
REM *****

```

7.3.10 Averaging I/Q Data

The R&S ESCI has averaging capability also for I/Q measurements, i.e. I/Q data can be averaged over several test runs. This is subject to the following conditions:

1. An external trigger signal must be available for data measurement, and the trigger signal must be phase-locked to the signal measured.
2. The same reference-frequency signal must be used for the DUT and the R&S ESCI.
3. The sampling rate must be 32 MHz, since only with this sampling frequency will the measurement be performed phase-synchronous with the trigger signal.

If all of the above conditions are fulfilled, no phase shift will occur between consecutive test runs. Phase shift may invalidate the measured average so that in extreme cases a value of 0 is obtained.

The default setting of the instrument for data measurement without averaging has to be changed as follows:

```

'----- R&S ESCI default setting -----
CALL SetupInstrument
           'Default setting
status = viWrite(analyzer, "TRAC:IQ:STAT ON", 15, retCnt)
           'Activate I/Q data acquisition mode; this must be
           'done before TRAC:IQ:SET!
           'Select max. number of test points (= 128 * 1024 - 512) at
           10 MHz RBW, 32 MHz sampling rate, external trigger, pos.
           trigger edge and 0 s trigger delay.
status = viWrite(analyzer, "TRAC:IQ:SET NORM,10MHz,32MHz,EXT,POS,0,130560",
45, retCnt)
status = viWrite(analyzer, "TRAC:IQ:AVER ON", 15, retCnt)
           'Switch on I/Q averaging
status = viWrite(analyzer, "TRAC:IQ:AVER:COUN 10", 20, retCnt)
           'Set 10 test runs
'----- Read data in binary format -----
...

```

7.3.11 Reading and Writing Files

7.3.11.1 Reading a File from the Instrument

In the following example, file TEST1.SET stored under D:\USER\DATA is read from the instrument and stored in the controller.

```

REM *****
Public Sub ReadFile()
    '----- Generate variables -----
    Dim digits As Byte
        'Number of digits of length information
    Dim fileBytes As Long
        'Length of file with trace data in bytes
    result$ = Space$(100) 'Buffer for simple results
    '----- Default setting of status register -----
    Call SetupStatusReg
        'Configure status register
    '----- Read out file -----
    status = viWrite(analyzer, "MMEM:DATA? 'D:\USER\DATA\TEST1.SET'", 35, retCnt)
        'Select file
    status = viRead(analyzer, result$, 2, retCnt)
        'Read and store number of
    digits = Val(Mid$(result$, 2, 1))
        'digits of length information
    status = viRead(analyzer, result$, digits, retCnt)
        'Read and store length
    fileBytes = Val(Left$(result$, digits))
        'information
    FileBuffer$ = Space$(fileBytes)
        'Buffer for file
    status = viRead(analyzer, FileBuffer, fileBytes, retCnt)
        'Read file into buffer
    status = viRead(analyzer, result$, 1, retCnt)
        'Read terminator <NL>
    '----- Store file to controller -----
    Open "TEST1.SET" For Output As #1
    Print #1, FileBuffer;
        ' ; to avoid linefeed at end of file
    Close #1
END SUB
REM *****

```

7.3.11.2 Creating a File on the Instrument

In the following example, the TEST1.SET file available on the controller is stored in the instrument under D:\USER\DATA\DUPLICAT.SET.

```

REM *****
Public Sub WriteFile()
    '----- Generate variables -----
FileBuffer$ = Space$(100000)
    'Buffer for file
Dim digits As Long
    'Number of digits of length information
Dim fileBytes As Long
    'Length of file in bytes
fileSize$ = Space$(100)
    'Length of file as a string
result$ = Space$(100)
    'Buffer for simple results
    '----- Default setting of status register -----
Call SetupStatusReg
    'Configure status register
    '----- Prepare the definite length block data -----
fileBytes = FileLen("test1.set")
    'Determine length of file
fileSize$ = Str$(fileBytes)
digits = Len(fileSize$) - 1
    'Determine number of digits of
fileSize$ = Right$(fileSize$, digits)
    'length information
FileBuffer$ = "#" + Right$(Str$(digits), 1) + fileSize$
    'Store length information in file buffer
    '----- Read file from controller -----
Open "TEST1.SET" For Binary As #1
FileBuffer$ = FileBuffer$ + Left$(Input(fileBytes, #1), fileBytes)
Close #1
    '----- Write file -----
status = viWrite(analyzer, "SYST:COMM:PIB:RTER EOI", 23, retCnt)
    'Set receive terminator on the instrument
status = viWrite(analyzer, "MMEM:DATA 'D:\USER\DATA\DUPLICAT.SET'," +
FileBuffer$, 36 + Len(FileBuffer$), retCnt)
    'Select file
END SUB
REM *****

```

8 Maintenance and Instrument Interfaces

8.1 Introduction	8.1
8.2 Maintenance	8.2
8.2.1 Storing and Packing	8.2
8.2.2 List of Power Cables Available	8.2
8.3 Instrument Interfaces	8.2
8.3.1 GPIB Interface	8.2
8.3.1.1 Interface Characteristics	8.3
8.3.1.2 Bus Lines	8.3
8.3.1.3 Interface Functions	8.4
8.3.1.4 GPIB Messages	8.4
8.3.2 Printer Interface (LPT)	8.5
8.3.3 RS-232-C Interface (COM)	8.6
8.3.3.1 Interface Characteristics	8.6
8.3.3.2 Signal Lines	8.7
8.3.3.3 Transmission Parameters	8.8
8.3.3.4 Control Characters	8.8
8.3.3.5 Handshake	8.9

8.1 Introduction

The following chapter contains information on the maintenance of the R&S ESCI and on the instrument interfaces:

- [“Maintenance” on page 8.2](#)
- [“Instrument Interfaces” on page 8.2](#)

Please follow the instructions in the service manual when exchanging modules or ordering spares. The order no. for spare parts can be found in the service manual.

The address of our support center and a list of all Rohde & Schwarz service centers can be found at the beginning of this manual.

The service manual includes further information particularly on troubleshooting, repair, exchange of modules (including battery exchange, adjustment of the OCXO oscillator) and calibration.

8.2 Maintenance

8.2.1 Storing and Packing

For the storage temperature range of the R&S ESCI, see the instrument specifications. When stored for an extended period of time the instrument should be protected against dust.

The original packing should be used, particularly the protective covers at the front and rear, when the instrument is to be transported or dispatched. If the original packing is no longer available, use a sturdy cardboard box of suitable size and carefully wrap the instrument to protect it against mechanical damage.

8.2.2 List of Power Cables Available

Stock No.	Earthed-contact connector	Preferably used in
DS 006.7013	BS1363: 1967' complying with IEC 83: 1975 standard B2	Great Britain
DS 006.7020	Type 12 complying with SEV-regulation 1011.1059, standard sheet S 24 507	Switzerland
DS 006.7036	Type 498/13 complying with US-regulation UL 498, or with IEC 83	USA/Canada
DS 006.7107	Type SAA3 10 A, 250 V, complying with AS C112-1964 Ap.	Australia
DS 0025.2365	DIN 49 441, 10 A, 250 V, angular	Europe (except Switzerland)
DS 0099.1456	DIN 49 441, 10 A, 250 V, straight	

8.3 Instrument Interfaces

In this section, only a selection of connectors is described:

- [“GPIB Interface” on page 8.2](#)
- [“Printer Interface \(LPT\)” on page 8.5](#)
- [“RS-232-C Interface \(COM\)” on page 8.6](#)

For further information on the front and back panel connectors refer to the Quick Start Guide, chapter 1.

8.3.1 GPIB Interface

The standard instrument is equipped with an GPIB connector. An IEEE 488 interface connector is located on the rear panel of the R&S ESCI. An external controller for remote control of the instrument can be connected via the IEEE 488 interface connector using a shielded cable.

8.3.1.1 Interface Characteristics

- 8-bit parallel data transfer
- bi-directional data transfer
- three-line handshake
- high data transfer rate
- up to 15 instruments can be connected
- maximal length of the interconnecting cables 15 m (single connection, 2m)
- wired-OR connection if several instruments are connected in parallel.

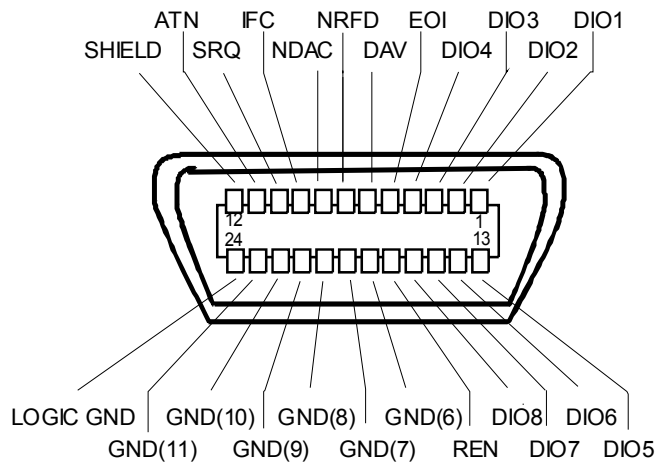

Fig. 8.1 Pin assignment of GPIB interface

8.3.1.2 Bus Lines

Data bus with 8 lines DIO 1 to DIO 8.

The transmission is bit-parallel and byte-serial in the ASCII/ISO code. DIO1 is the least significant, DIO8 the most significant bit.

Control bus with 5 lines.

IFC (Interface Clear),

active low resets the interfaces of the devices connected to the default setting.

ATN (Attention),

active low signals the transmission of interface messages

inactive high signals the transmission of device messages.

SRQ (Service Request),

active low enables a device connected to send a service request to the controller.

REN (Remote Enable),

active low permits the switch over to remote control.

EOI (End or Identify),

has two functions in connection with ATN:

active low marks the end of data transmission when ATN=high

active low triggers a parallel poll when ATN=low.

Handshake bus with three lines.

DAV (Data Valid),
active low signals a valid data byte on the data bus.

NRFD (Not Ready For Data),
active low signals that one of the devices connected is not ready for data transfer.

NDAC (Not Data Accepted),
active low as long as the device connected is accepting the data present on the data bus.

8.3.1.3 Interface Functions

Instruments which can be remote controlled via the GPIB can be equipped with different interface functions. The table below lists the interface functions appropriate for the instrument.

Control character	Interface function
SH1	Handshake source function (source handshake), full capability
AH1	Handshake sink function (acceptor handshake), full capability
L4	Listener function, full capability, unaddress if MTA.
T6	Talker function, full capability, ability to respond to serial poll, unaddress if MLA
SR1	Service request function (Service Request), full capability
PP1	Parallel poll function, full capability
RL1	Remote/Local switch over function, full capability
DC1	Reset function (Device Clear), full capability
DT1	Trigger function (Device Trigger), full capability
C0	No controller function

8.3.1.4 GPIB Messages

The messages transferred via the data lines of the GPIB can be divided into two groups:

- “Interface Messages” on page 8.4
- “Instrument Messages” on page 8.5

Interface Messages

Interface messages are transferred on the data lines of the GPIB when the "ATN" control line is active (LOW). They are used for communication between controller and instruments and can only be sent by the controller which currently has control of the GPIB.

Universal Commands

The universal commands are encoded 10 - 1F hex. They affect all instruments connected to the bus without addressing.

Command	QuickBASIC command	Effect on the instrument
DCL (Device Clear)	IBCMD (controller%, CHR\$(20))	Aborts the processing of the commands just received and sets the command processing software to a defined initial state. Does not change the instrument settings.
IFC (Interface Clear)	IBSIC (controller%)	Resets the interfaces to the default setting.
LLO (Local Lockout)	IBCMD (controller%, CHR\$(17))	The LOC/IEC ADDR key is disabled.
SPE (Serial Poll Enable)	IBCMD (controller%, CHR\$(24))	Ready for serial poll.
SPD (Serial Poll Disable)	IBCMD (controller%, CHR\$(25))	End of serial poll.
PPU (Parallel Poll Unconfigure)	IBCMD (controller%, CHR\$(21))	End of the parallel-poll state.

Addressed Commands

The addressed commands are encoded 00 - 0F hex. They are only effective for instruments addressed as listeners.

Command	QuickBASIC command	Effect on the instrument
SDC (Selected Device Clear)	IBCLR (device%)	Aborts the processing of the commands just received and sets the command processing software to a defined initial state. Does not change the instrument setting.
GTL (Go to Local)	IBLOC (device%)	Transition to the "Local" state (manual operation).
PPC (Parallel Poll Configure)	IBPPC (device%, data%)	Configure instrument for parallel poll. Additionally, the QuickBASIC command executes PPE/PPD.

Instrument Messages

Instrument messages are transferred on the data lines of the GPIB if the "ATN" control line is not active. ASCII code is used.

Structure and syntax of the instrument messages are described in chapter "Remote Control – Basics". The commands are listed and explained in detail in chapter "Remote Control – Description of Commands".

8.3.2 Printer Interface (LPT)

The instrument is equipped with a 25-pin LPT connector on the rear panel for connecting a printer. In Fig. 8.2 the pin assignment is described. The LPT interface is compatible with the CENTRONICS printer interface.

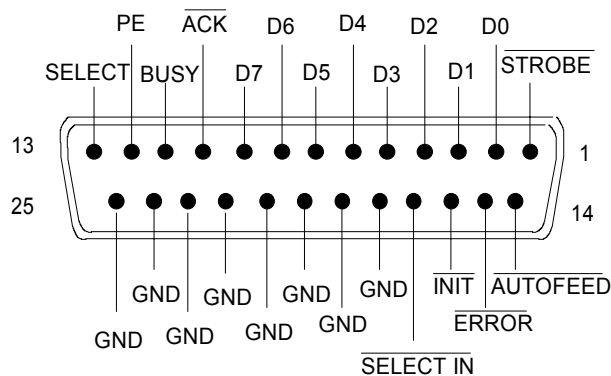

Fig. 8.2 LPT connector pin assignment

Pin	Signal	Input (I) Output (O)	Description
1	STROBE	O	Pulse for transmitting a data byte, min. 1 μ s pulse width (active LOW)
2	D0	O	Data Line 0
3	D1	O	Data Line 1
4	D2	O	Data Line 2
5	D3	O	Data Line 3
6	D4	O	Data Line 4
7	D5	O	Data Line 5
8	D6	O	Data Line 6
9	D7	O	Data Line 7
10	ACK	I	Indicates that the printer is ready to receive the next byte. (active LOW)
11	BUSY	I	Signal is active when the printer cannot accept data. (active HIGH)
12	PE	I	Signal is active when the paper tray is empty. (active HIGH)
13	SELECT	I	Signal is active when the printer is selected. (active HIGH)
14	AUTOFEED	O	When signal is active, the printer automatically performs a line feed after each line. (active LOW)
15	ERROR	I	This signal is high when the printer has no paper, is not selected or has an error status. (active LOW)
16	INIT	O	Initialize the printer. (active LOW)
17	SELECT IN	O	If signal is active, the codes DC1/DC3 are ignored by the printer. (active LOW).
18 - 25	GND		Ground connection.

Fig. 8.3 Pin assignments for the LPT connector.

8.3.3 RS-232-C Interface (COM)

The standard R&S ESCI is equipped with a RS-232-C serial interface. The interface can be set up and activated manually in the *SETUP-GENERAL SETUP* menu in the *COM INTERFACE* table (selection *OWNER = INSTRUMENT*) for remote control. For details on the connector refer to the Quick Start Guide, chapter 1.

8.3.3.1 Interface Characteristics

- Serial data transmission in asynchronous mode
- Bi-directional data transfer via two separate lines
- Transmission rate selectable from 110 to 138000 baud
- Logic '0' signal from +3 V to +15 V
- Logic '1' signal from -15 V to -3 V
- External instrument (controller) can be connected

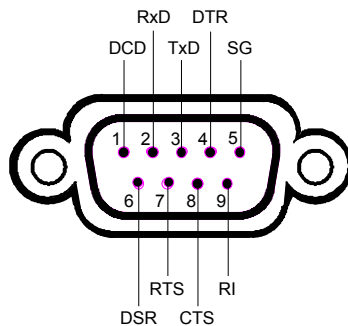

Fig. 8.4 Pin assignment of the RS-232-C interface

8.3.3.2 Signal Lines

- **DCD** (Data Carrier Detect)

Not used in R&S ESCI.

Input; active LOW.

Using this signal, the local terminal recognizes that the modem of the remote station receives valid signals with sufficient level. DCD is used to disable the receiver in the local terminal and prevent reading of false data if the modem cannot interpret the signals of the remote station.

- **RxD** (Receive Data)

Input, LOW = logic '1', HIGH = logic '0'.

Data line, local terminal receives data from remote station.

- **TxD** (Transmit Data)

Output, LOW = logic '1', HIGH = logic '0'.

Data line, local terminal transmits data to remote station.

- **DTR** (Data Terminal Ready)

Output, active LOW,

Indicates that the local terminal is ready to receive data.

- **GND**

Interface ground, connected to instrument ground

- **DSR** (Data Set Ready)

Input, active LOW,

Indicates that the remote station is ready to receive data.

- **RTS** (Request To Send)

Output, active LOW.

Indicates that the local terminal wants to transmit data.

- **CTS** (Clear To Send)

Input, active LOW.

Used to tell the local terminal that the remote station is ready to receive data.

- **RI** (Ring Indicator)

Not used in R&S ESCI.

Input, active LOW.

Used by a modem to indicate that a remote station wants to establish a connection.

8.3.3.3 Transmission Parameters

To ensure error-free data transmission, the parameters of the instrument and the controller must have the same settings. The parameters are defined in the SETUP-GENERAL SETUP menu.

Transmission rate (baud rate)	The following transmission rates can be set in the instrument: 110, 300, 600, 1200, 2400, 4800, 9600, 19200, 38400, 57600, 115200, 138000.
Data bits	Data transmission is in 7- or 8-bit ASCII code. The first bit transmitted is the LSB (least significant bit).
Start bit	Each data byte starts with a start bit. The falling edge of the start bit indicates the beginning of the data byte.
Parity bit	In order to detect errors, a parity bit may be transmitted. No parity, even parity or odd parity may be selected. In addition, the parity bit can be set to logic '0' or to logic '1'.
Stop bits	The transmission of a data byte is terminated by 1, 1.5 or 2 stop bits.

Example

Transmission of character 'A' (41 hex) in 7-bit ASCII code, with even parity and 2 stop bits:

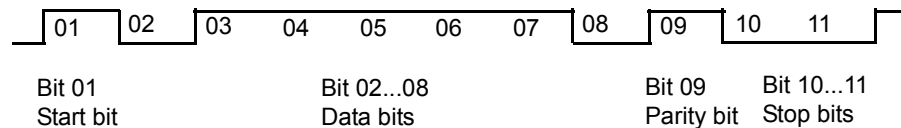

8.3.3.4 Control Characters

For interface control, several strings are defined and control characters are reserved which are based upon GPIB control.

Control string or character	Function
'@REM'	Switch over to remote
'@LOC'	Switch over to local
'@SRQ'	Service Request SRQ (SRQ is sent by the instrument)
'@GET'	Group Execute Trigger (GET)
'@DCL'	Reset instrument (Device Clear DCL)
<Ctrl Q> 11 Hex	Enables character output / XON
<Ctrl S> 13 Hex	Inhibits character output / XOFF
0D Hex, 0A Hex	Terminator <CR>, <LF>

8.3.3.5 Handshake

Software handshake

In the software handshake mode of operation, the data transfer is controlled using the two control characters XON / XOFF.

The instrument uses the control character XON to indicate that it is ready to receive data. If the receive buffer is full, it sends the XOFF character via the interface to the controller. The controller then interrupts the data output until it receives another XON from the instrument. The controller indicates to the instrument that it is ready to receive data in the same way.

Cable required for software handshake

The connection of the instrument with a controller for software handshake is made by crossing the data lines. The following wiring diagram applies to a controller with a 9-pin or 25-pin configuration.

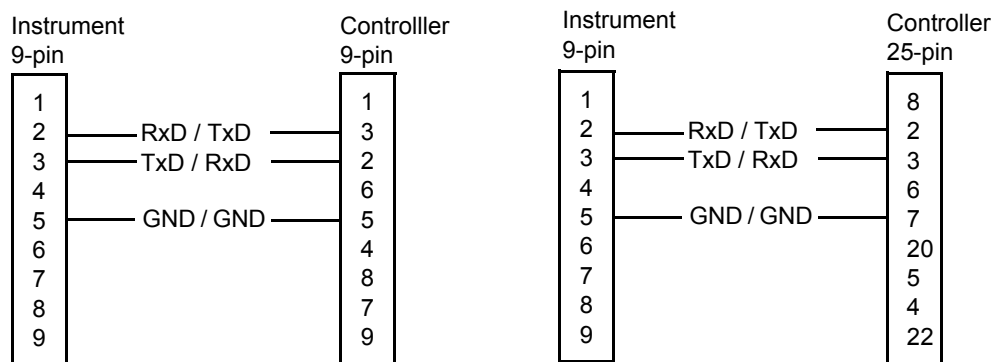

Fig. 8.5 Wiring of the data lines for software handshake

Hardware handshake

For hardware handshake, the instrument indicates that it is ready to receive data via the lines DTR and RTS. A logic '0' on both lines means 'ready' and a logic '1' means 'not ready'. The RTS line is always active (logic '0') as long as the serial interface is switched on. The DTR line thus controls the readiness of the instrument to receive data.

The readiness of the remote station to receive data is reported to the instrument via the CTS and DSR line. A logic '0' on both lines activates the data output and a logic '1' on both lines stops the data output of the instrument. The data output takes place via the TxD line.

Cable for hardware handshake

The connection of the instrument to a controller is made with a so-called zero modem cable. Here, the data, control and acknowledge lines must be crossed. The following wiring diagram applies to a controller with a 9-pin or 25-pin configuration.

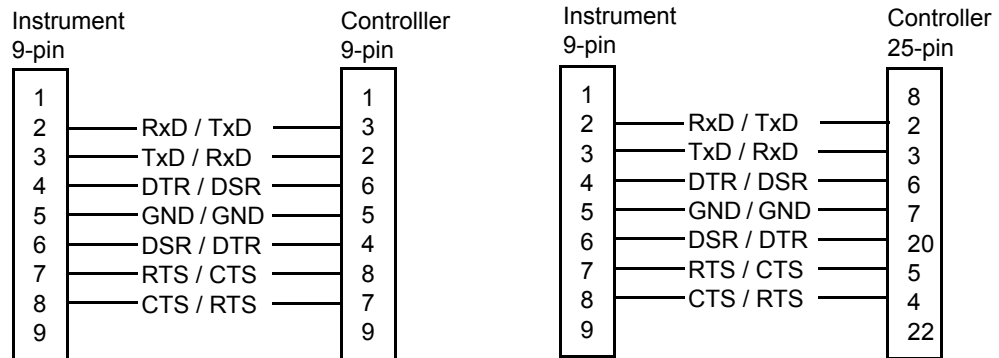

Fig. 8.6 Wiring of the data, control and acknowledge lines for hardware handshake

9 Error Messages

9.1 Introduction	9.2
9.2 SCPI-Specific Error Messages	9.3
9.3 Device-Specific Messages	9.8

9.1 Introduction

Error messages are entered in the error/event queue of the status reporting system in the remote control mode and can be queried with the command `SYSTEM:ERROR?`. The answer format of R&S ESCI to the command is as follows:

```
<error code>, "<error text with queue query>;  
<remote control command concerned>"
```

The indication of the remote control command with prefixed semicolon is optional.

Example:

The command `TEST:COMMAND` generates the following answer to the query `SYSTEM:ERROR?`:

```
-113,"Undefined header;TEST:COMMAND"
```

The subsequent list contains the description of error texts displayed on the instrument.

Distinction is made between error messages defined by SCPI, which are marked by negative error codes, and the device-specific error messages for which positive error codes are used:

- [9.2“SCPI-Specific Error Messages” on page 9.3](#)
- [“Device-Specific Messages” on page 9.8](#)

The right-hand column in the following tables contains the error text in bold which is entered in the error/event queue and can be read out by means of query `SYSTEM:ERROR?`. A short explanation of the error cause is given below. The left-hand column contains the associated error code.

9.2 SCPI-Specific Error Messages

Error code	Error text in the case of queue poll Error explanation
0	No error This message is output if the error queue does not contain any entries.

Error code	Error text in the case of queue poll Error explanation
-100	Command Error The command is faulty or invalid.
-101	Invalid Character The command contains an invalid sign. Example: A header contains an ampersand, "SENSe&".
-102	Syntax error The command is invalid. Example: The command contains block data the instrument does not accept.
-103	Invalid separator The command contains an invalid sign instead of a separator. Example: A semicolon is missing after the command.
-104	Data type error The command contains an invalid value indication. Example: ON is indicated instead of a numeric value for frequency setting.
-105	GET not allowed A Group Execute Trigger (GET) is within a command line.
-108	Parameter not allowed The command contains too many parameters. Example: Command <code>SENSe:FREQuency:CENTer</code> permits only one frequency indication.
-109	Missing parameter The command contains too few parameters. Example: The command <code>SENSe:FREQuency:CENTer</code> requires a frequency indication.
-110	Command header error The header of the command is faulty.
-111	Header separator error The header contains an invalid separator. Example: the header is not followed by a "White Space", "*ESE255"
-112	Program mnemonic too long The header contains more than 12 characters.
-113	Undefined header The header is not defined for the instrument. Example: *XYZ is undefined for every instrument.

SCPI-Specific Error Messages

Error code	Error text in the case of queue poll Error explanation
-114	Header suffix out of range The header contains an invalid numeric suffix. Example: <code>SENSe3</code> does not exist in the instrument.
-120	Numeric data error The command contains a faulty numeric parameter.
-121	Invalid character in number A number contains an invalid character. Example: An "A" in a decimal number or a "9" in an octal number.
-123	Exponent too large The absolute value of the exponent is greater than 32000.
-124	Too many digits The number includes too many digits.
-128	Numeric data not allowed The command includes a number which is not allowed at this position. Example: The command <code>INPut:COUPling</code> requires indication of a text parameter.
-130	Suffix error The command contains a faulty suffix.
-131	Invalid suffix The suffix is invalid for this instrument. Example: <code>nHz</code> is not defined.
-134	Suffix too long The suffix contains more than 12 characters.
-138	Suffix not allowed A suffix is not allowed for this command or at this position of the command. Example: The command <code>*RCL</code> does not permit a suffix to be indicated.
-140	Character data error The command contains a faulty text parameter
-141	Invalid character data The text parameter either contains an invalid character or it is invalid for this command. Example: Write error with parameter indication; <code>INPut:COUPling XC</code> .
-144	Character data too long The text parameter contains more than 12 characters.
-148	Character data not allowed The text parameter is not allowed for this command or at this position of the command. Example: The command <code>*RCL</code> requires a number to be indicated.
-150	String data error The command contains a faulty string.
-151	Invalid string data The command contains a faulty string. Example: An END message has been received prior to the terminating apostrophe.

SCPI-Specific Error Messages

Error code	Error text in the case of queue poll Error explanation
-158	String data not allowed The command contains a valid string at a position which is not allowed. Example: A text parameter is set in quotation marks, <code>INPut:COUPLing "DC"</code>
-160	Block data error The command contains faulty block data.
-161	Invalid block data The command contains faulty block data. Example: An END message was received prior to reception of the expected number of data.
-168	Block data not allowed The command contains valid block data at an invalid position. Example: The command <code>*RCL</code> requires a number to be indicated.
-170	Expression error The command contains an invalid mathematical expression.
-171	Invalid expression The command contains an invalid mathematical expression. Example: The expression contains mismatching parentheses.
-178	Expression data not allowed The command contains a mathematical expression at an invalid position.

Error code	Error text in the case of queue poll Error explanation
-200	Execution error Error on execution of the command.
-201	Invalid while in local The command is not executable while the device is in local due to a hard local control. Example: The device receives a command which would change the rotary knob state, but the device is in local so the command can not be executed.
-202	Settings lost due to rtl A setting associated with hard local control was lost when the device changed to LOCS from REMS or to LWLS from RWLS.
-210	Trigger error Error on triggering the device.
-211	Trigger ignored The trigger (GET, *TRG or trigger signal) was ignored because of device timing considerations. Example: The device was not ready to respond.
-212	Arm ignored An arming signal was ignored by the device.
-213	Init ignored Measurement initialization was ignored as another measurement was already in progress.

SCPI-Specific Error Messages

Error code	Error text in the case of queue poll Error explanation
-214	Trigger deadlock The trigger source for the initiation of measurement is set to GET and subsequent measurement is received. The measurement cannot be started until a GET is received, but the GET would cause an interrupted-error)
-215	Arm deadlock The trigger source for the initiation of measurement is set to GET and subsequent measurement is received. The measurement cannot be started until a GET is received, but the GET would cause an interrupted-error.
-220	Parameter error The command contains a faulty or invalid parameter.
-221	Settings conflict There is a conflict between setting of parameter value and instrument state.
-222	Data out of range The parameter value lies out of the allowed range of the instrument.
-223	Too much data The command contains too many data. Example: The instrument does not have sufficient storage space.
-224	Illegal parameter value The parameter value is invalid. Example: The text parameter is invalid, TRIGger:SWEep:SOURce TASTe
-230	Data corrupt or stale The data are incomplete or invalid. Example: The instrument has aborted a measurement.
-231	Data questionable The measurement accuracy is suspect.
-240	Hardware error The command cannot be executed due to problems with the instrument hardware.
-241	Hardware missing Hardware is missing. Example: An option is not fitted.
-250	Mass storage error A mass storage error occurred.
-251	Missing mass storage The mass storage is missing. Example: An option is not installed.
-252	Missing media The media is missing.
-253	Corrupt media The media is corrupt.

SCPI-Specific Error Messages

Error code	Error text in the case of queue poll Error explanation
-254	Media full The media is full.
-255	Directory full The media directory is full.
-256	File name not found The file name cannot be found on the media.
-257	File name error The file name is wrong. Example: An attempt is made to copy to a duplicate file name.
-258	Media protected The media is protected.
-260	Expression error The expression contains an error.

Error code	Error text in the case of queue poll Error explanation
-300	Device-specific error R&S ESCI-specific error not defined in greater detail.
-310	System error This error message suggests an error within the instrument. Please inform the R&S Service.
-313	Calibration memory lost Loss of the non-volatile data stored using the *CAL? command. This error occurs when the correction data recording has failed.
-330	Selftest failed The selftest could not be executed.
-350	Queue overflow This error code is entered in the queue instead of the actual error code if the queue is full. It indicates that an error has occurred but not been accepted. The queue can accept 5 entries.

Error code	Error text in the case of queue poll Error explanation
-400	Query error General error occurring when data are requested by a query.
-410	Query INTERRUPTED The query has been interrupted. Example: After a query, the instrument receives new data before the response has been sent completely.

Error code	Error text in the case of queue poll Error explanation
-420	Query UNTERMINATED The query is incomplete. Example: The instrument is addressed as a talker and receives incomplete data.
-430	Query DEADLOCKED The query cannot be processed. Example: The input and output buffers are full, the instrument cannot continue operation.
-440	Query UNTERMINATED after indefinite response A query is in the same command line after a query which requests an indefinite response.

9.3 Device-Specific Messages

Table 9-1 Device-specific messages

Error code	Error text in the case of queue poll Error explanation
1036	MS: The correction table based amplifier gain exceeds the amplifier range for CALAMP1 and CALAMP2 on IF board This message is output when the setting range of the calibration amplifier is not sufficient for the required correction. The error occurs only with modules which are not correctly adjusted or defective.
1052	Frontend LO is Unlocked This message is output when the phase regulation of the local oscillator fails in the RF frontend.
1060	Trigger-Block Gate Delay Error- gate length < Gate Delay This message is output when the gate signal length is not sufficient for the pull-in delay with a predefined gate delay.
2022	OPTIONS.INI invalid This message is output when an error has been recognized in the file OPTIONS.INI which contains the clearing codes for retrofitable firmware applications. If this file is not correctly recognized, all firmware applications are blocked for this instrument.
2028	Hardcopy not possible during measurement sequence This message is output when a printout is started during scan sequences that cannot be interrupted. Such sequences are for example: <ul style="list-style-type: none"> Recording the system error correction data (calibration) Instrument selftest In such cases a synchronization to the end of the scan sequence should be performed prior to starting the printout.
2033	Printer Not Available This message is output when the selected printer is not included in the list of available output devices. A possible cause is that the required printer driver is missing or incorrectly installed.
2034	CPU Temperature is too high This message is output when the temperature of the processor exceeds 70 °C.

Index

Symbols

* (enhancement label) 4.104

Numerics

10 dB setting 4.17
 3 dB bandwidths 4.19
 6 dB bandwidths 4.19
 6 dB filter 4.19

A

Abort
 recording of correction data . . . 4.114
Absolute/relative channel power . 4.160
ACP measurement 4.145
Addressed command 8.5
Adjacent-channel power
 number of channels 4.156
AF demodulation 4.131
Alphabetical list of remote commands 6.330
AM demodulation 4.31, 4.131
AM modulation 4.294
 depth 4.180
Amplitude 4.79
 probability distribution function 4.172
 statistics 4.169
Analyzer mode 4.74
Annotation 4.226
APD function 4.172
ASCII file export
 final measurement data 4.38
 scan data 4.71
Attenuation 4.16, 4.81
Autopoint detector 4.111
Average detector 4.26, 4.28, 4.110, 4.112
Averaging 4.103, 4.143
 continuous sweep 4.104
 lin/log 4.105
 single sweep 4.104
 sweep count 4.103
Axis
 adjustment 4.57

B

Band filter
 digital 4.20, 4.88
Bandwidth
 occupied 4.167
 resolution 4.84
 video 4.84
Baud rate 4.250
Block data 5.14
Boolean parameter 5.14
Brightness 4.227
 screen 4.278

C

Cables EZ-xx 4.47
Calibration
 functioning 4.291, 4.305

reflection measurement 4.291, 4.305
 results 4.114
 transmission measurement . 4.285
CCDF function 4.172
CCIR 473-4 4.281
CCVS signal 4.282
Center frequency 4.75
 step size 4.75
Channel
 bandwidth 4.156, 4.167, 4.179
 filters 4.21
 number 4.155, 4.156
 power 4.160
 spacing 4.157
Channel filters 4.89
Channel power measurement . . . 4.149
Characters
 special 6.6
CISPR average detector . . . 4.26, 4.112
CISPR RMS detector 4.112
Clear/Write mode 4.69, 4.102
Colon 5.15
Color 4.228, 4.276
Color printout 4.276
COM interface 8.6
Comma 5.15
Command
 # 5.15
 addressed 8.5
 colon 5.15
 comma 5.15
 common 6.8
 description 6.5
 header 5.10
 line 5.11
 long form 5.11
 overlapping execution 5.17
 programming examples 7.2
 query 5.12
 question mark 5.12, 5.15
 quotation mark 5.15
 recognition 5.16
 sequence 5.17
 short form 5.11
 structure 5.9
 suffix 5.11
 syntax elements 5.15
 universal 8.4
 white space 5.15
COMPUTER NAME 4.253
CONDition part status register . . . 5.19
Configuration 4.228
 save 4.264
Connection cables 4.47
Continue single sweep 4.92
Continuous sweep 4.91
Control
 characters 8.8
 output level 4.284
Copy
 file 4.271
 limit line 4.212
 trace 4.73, 4.108

- Correction
 - inherent noise 4.151
- Correction data 4.113
- Correction values
 - normalization 4.283, 4.297
- Counter resolution 4.122
- Coupling
 - bandwidths 4.83
 - default settings 4.86, 4.88
 - frequency of diagrams 4.225
 - IF bandwidth to frequency range 4.20, 4.28
 - reference level of diagrams . . . 4.224
 - resolution bandwidth 4.85
 - sweep time 4.86
 - video bandwidth 4.85
- Create directory 4.270
- Cumulative distribution function . . . 4.172

- D**
- Data reduction 4.31
- Date 4.225
 - input 4.252
- DCL 5.16
- Decimal separator 4.38
 - Comma 4.38
 - Decimal point 4.38
- Default
 - coupling ratios 4.86
 - display settings 4.226
 - scalings of x- and y-axis. 4.174
 - scan table 4.49
- Delay
 - gate signal 4.98
- Delete
 - file 4.272
 - limit line 4.212
 - line of peak list 4.38
 - scan range 4.57
 - transducer factor/set 4.238
- Demodulation 4.30, 4.131
- Detector
 - autopeak 4.109
 - average 4.26, 4.28, 4.110
 - CISPR 4.26
 - max peak 4.26, 4.27, 4.109
 - min peak 4.26, 4.28, 4.109
 - quasi-peak . . . 4.27, 4.28, 4.68, 4.70
 - quasipeak 4.110
 - RMS. 4.26, 4.28, 4.109
 - sample 4.109
- Device reset (overall) 4.6
- Device-specific messages
 - error messages 9.8
- DHCP ON | OFF 4.253
- Discontinuous interferences. 4.50
- Diskette
 - format 4.273
- Display
 - brightness 4.227
 - color 4.228
 - date 4.225
 - deactivation during single sweep 4.93
 - power-save mode 4.226
 - saturation 4.227
 - time 4.225
 - tint 4.227
 - title 4.225
- Display line 4.218
- Display mode
 - split screen 4.222
- Display range
 - frequency 4.75
 - level 4.16, 4.80
 - span 4.78
- Distribution function 4.172
- Double dagger 5.15

- E**
- ENABLE part status register. 5.20
- Error messages. 4.258, 9.2
 - device-specific 9.8
 - SPCI-specific 9.3
- Error queue query 5.31
- Error variable - iberr 4.321
- ESE (event status enable register) .5.23
- ESR (event status register) 5.23
- EVENT part status register 5.20
- EXT TRIGGER/GATE input 4.60
- External Generator (R&S FSP-B10 option) 4.297
 - External noise source 4.263
 - External trigger/gate input. 4.94
 - EZ-14 4.47
 - EZ-21 4.47
 - EZ-5 4.47
 - EZ-6 4.47

- F**
- Fast power measurement. 4.151
- FFT filter 4.20, 4.88
- Field, first or second 4.281
- File
 - copy 4.271
 - delete 4.272
 - rename 4.271
 - sort 4.272
- Filter
 - band filter 4.20, 4.88
 - FFT 4.20, 4.88
- Final measurement
 - automatic routine 4.41
 - continuation 4.43, 4.44
 - halt 4.43, 4.44
 - interactive routine 4.35, 4.41
 - interruption 4.42
 - measurement time 4.35, 4.41
 - start. 4.42
- firmware update 4.262
- Firmware version 4.257
- Fixed filter 4.88
- FM demodulation 4.31, 4.131
- FM modulation 4.294
- Free-run sweep 4.60, 4.94
- Frequency 4.75
 - center 4.75
 - counter 4.118
 - coupling of diagrams 4.225
 - display window 4.74, 4.78
 - line 4.219
 - offset 4.77
 - offset (ext. generator) 4.307

offset (tracking generator) . . . 4.293
 receiver 4.14, 4.25
 scan 4.54
 span 4.78
 start 4.76
 stop 4.77
 switching off display 4.226
 Frequency-converting measurements 4.293,
 4.307
 Front panel keys
 enable 4.10
 Full screen 4.222
 Full span 4.78

G

Gate
 delay 4.98
 external/internal 4.97
 length 4.98
 GET (Group Execute Trigger) 5.16
 GPIB
 address 4.246
 command description 6.5
 interface 8.2
 interface functions 8.4
 programming examples 7.2

H

Hardcopy
 screen 4.274
 Hardware adjustment 4.262
 Harmonic
 measurement 4.184
 Header 5.10
 Hold scan 4.59
 Horizontal sync signal 4.281
 Hotkey
 MIXED 4.9
 MORE 4.297
 NETWORK 4.283
 RECEIVER 4.9, 4.11, 4.12
 SCREEN A/B 4.9, 6.106
 SPECTRUM 4.9, 4.74, 6.128

I

I/Q modulation 4.295
 IF bandwidth
 coupling to frequency range 4.20, 4.28
 Impedance of input 4.82
 Impulse bandwidth 4.19
 Inherent noise
 correction 4.151
 Input
 external trigger/gate 4.60, 4.94
 impedance 4.82
 Instrument functions 4.1
 Interfaces 8.2
 GPIB 8.4
 Intermodulation product 4.181
 Interrupt 5.30
 scan 4.59
 IP ADDRESS 4.253
 IST flag 5.23

K**Key**

AMPT 4.16, 4.79
 BW 4.84
 CAL 4.113
 DISP 4.220
 ESC 6.25
 FILE 4.264
 FREQ 4.14, 4.74
 LINES 4.209, 4.218
 MEAS 4.23, 4.139
 MKR 4.60, 4.116
 MKR FCTN 4.66, 4.123
 MKR-> 4.63, 4.132
 PRESET 4.6, 6.10, 6.234
 SETUP 4.228
 SPAN 4.78
 SWEEP 4.48, 4.52, 4.91
 TRACE 4.68, 4.101
 TRIG 4.59, 4.93

L

Level 4.79
 axis unit 4.17
 display range 4.16, 4.80
 line 4.219
 offset (ext. generator) 4.298
 offset (external generator) 4.298
 offset (phase noise) 4.127
 offset (tracking generator) 4.284
 range 4.80
 reference 4.80

Limit

ACP measurement 4.162
 evaluation range 4.142
 probability range 4.174
 Limit check 4.211
 ACP measurement 4.161

Limit line

copy 4.212
 delete 4.212
 domain 4.215
 edit 4.213
 limit check 4.211
 offset 4.212
 scaling 4.215
 select 4.211
 shift 4.218
 unit 4.216
 value 4.217

Line

frequency (Frequency Line 1, 2) 4.219
 level (Display Line 1,2) 4.219
 limit 4.211
 reference (tracking generator) 4.287, 4.301
 threshold 4.66, 4.135
 time (Time Line 1, 2) 4.220
 Line impedance stabilization networks 4.45
 Line system 4.282
 LISN 4.45
 LO exclude 4.136
 Logo 4.225
 Lower case 6.6
 LPT interface 8.5

M

Maintenance 8.1

Manual operation

- return to* 5.5, 5.7
- switch to* 4.10

Margin 4.35, 4.41

Marker 4.115

- center frequency to* 4.133
- CF stepsize to* 4.65, 4.135
- MKR to* 4.132
- N dB Down* 4.128
- normal* 4.116
- peak* 4.64, 4.67, 4.124, 4.133
- reference level to* 4.134
- repeated sweep* 4.248
- search limit* 4.65, 4.135
- signal track* 4.77
- to trace* 4.61, 4.64, 4.67, 4.121, 4.132
- zoom* 4.120

Max hold 4.69, 4.102

Max peak detector ... 4.26, 4.27, 4.112

Maximum

- peak value* 4.143
- search* 4.64, 4.133
- value* 4.141

Mean power (GSM burst) 4.142

Mean value 4.142

Measurement

- carrier/noise ratio C/N and C/No* 4.178
- converters* 4.235
- frequency-converting* . 4.293, 4.307
- reflection* 4.290, 4.304
- storing data (ASCII format)* . 4.191
- time* 4.29
- transmission* 4.285, 4.299

Measurement example

- ACP with user-specific channel configuration* 4.164
- adjacent-channel power for a specific standard* 4.164
- CCDF of a IS95 BTS signal* . 4.175
- occupied bandwidth of a PDC signal* 4.169
- signal/noise power density (C/No) of an IS95 CDMA signal* 4.165

Measurement results

- save* 4.264

Messages 4.258

Min hold 4.105

Min peak detector . . . 4.26, 4.28, 4.112

Minimum search 4.65, 4.136

Mobile radio standard 4.149

Mode

- analyzer* 4.74
- receiver* 4.11
- spectrum analysis* 4.74

Modulation

- depth* 4.180
- external (tracking generator)* . 4.294

N

Network 4.283

Noise

- correction* 4.151
- measurement* 4.124
- source, external* 4.263

Normalization 4.287, 4.301

NTRansition register part 5.19

Numerical values (command) 5.13

O

Occupied bandwidth 4.167

Offset

- frequency* 4.77
- frequency (ext. generator)* . . 4.307
- gate signal* 4.98
- level (tracking generator)* . . . 4.284
- limit line* 4.212
- phase noise* 4.127
- reference level* 4.82
- trigger* 4.95

Operating mode

- Receiver* 4.11
- receiver* 4.13

Operating time 4.257

Option

- FSP-B6 TV and RF Trigger* . 4.280
- FSP-B9 Tracking Generator* . 4.283

Order number 4.257

Output level

- control* 4.284

Overwrite mode 4.69, 4.102

OVL D 4.306

P

Packing 8.2

Parallel poll 5.30

- enable register (PPE)* 5.23

Parameter

- block data* 5.14
- boolean* 5.14
- coupling* 4.222
- numerical values* 5.13
- string* 5.14
- text* 5.14

Password

- service functions* 4.260

Path 4.270

Peak

- detector* 4.26, 4.70
- excursion* 4.66
- list* 4.37
- search* 4.67, 4.124, 4.133

Phase noise measurement (spectrum analysis mode) 4.125

Phase setting 4.46

Polarity

- external trigger/gate* 4.98
- trigger edge* 4.60, 4.95
- video* 4.282

Power

- bandwidth percentage* 4.167
- mean* 4.142

Power measurement 4.139

- CP/ACP* 4.145
- occupied bandwidth* 4.167
- signal amplitude statistics* . . . 4.169
- time domain* 4.140
- trace* 4.164

PPE (parallel poll enable register) . 5.23

Preamplification . . . 4.16, 4.233, 4.235

Preselection 4.233

- Preset instrument 4.6
 - Pretrigger 4.95
 - Print
 - start 4.274
 - Printer
 - configuration 4.274
 - connection 8.5
 - interface 8.5
 - Protective earth conductor . . 4.46, 4.233
 - Protective earth setting 4.46
 - PTransition part status register . . . 5.19
- Q**
- Quasi-peak detector 4.27, 4.28, 4.68, 4.70
 - Quasipeak detector 4.110
 - Query 5.12, 5.31
 - Question mark 5.12, 5.15
 - Quotation mark 5.15
- R**
- Receiver 4.11, 4.13
 - frequency 4.14, 4.25
 - frequency stepsize 4.14
 - level 4.16
 - Recording
 - correction data 4.113
 - Reference
 - dataset (external generator) . . 4.305
 - dataset (tracking generator) . . 4.291
 - external 4.231
 - fixed 4.119
 - frequency 4.119
 - level to marker level 4.134
 - line (tracking generator) 4.287, 4.301
 - position for normalization . . . 4.301
 - Reference level 4.80
 - channel power 4.152
 - coupling of diagrams 4.224
 - offset 4.82
 - position 4.82
 - to marker level 4.134
 - Reference point
 - frequency 4.119
 - frequency (phase noise) 4.127
 - level 4.119
 - level (phase noise) 4.127
 - offset 4.119, 4.127
 - time 4.120
 - Reference value
 - channel power 4.151
 - time domain power 4.143
 - Reflection measurement . . 4.290, 4.304
 - Remote commands
 - alphabetical list 6.330
 - Remote control
 - basics 5.1
 - GPIO 5.5
 - RS-232-C 5.6
 - RSIB 4.318
 - switch to 5.4
 - Rename
 - directory 4.271
 - file 4.271
 - Reset
 - device 4.6
 - status reporting system 5.31
 - Resolution bandwidth 4.19, 4.84
 - Resolution counter 4.122
 - RF attenuation 4.16, 4.81
 - RFI reception 4.11
 - RMS detector . . 4.26, 4.28, 4.109, 4.112
 - RMS value 4.141
 - RS-232-C
 - configuration 4.250
 - interface 8.6
- S**
- Sample detector 4.112
 - Sample number 4.173
 - Saturation 4.227
 - screen 4.278
 - Save
 - configuration 4.264
 - limit line 4.218
 - measurement 4.264
 - Scalar reflection measurement 4.290, 4.304
 - Scaling 4.80
 - level axis 4.82
 - limit line 4.215
 - x- and y-axis (signal statistic) . 4.173
 - Scan 4.48
 - default setup 4.49
 - entry 4.52
 - hold 4.59
 - run 4.58
 - stop 4.59
 - SCPI
 - conformity information 6.5
 - introduction 5.9
 - version 5.3
 - SCPI specific error messages 9.3
 - Screen
 - brightness 4.278
 - colors 4.279
 - full screen 4.222
 - hue 4.278
 - saturation 4.278
 - split screen 4.222
 - Search
 - bandwidth 4.77
 - minimum 4.65, 4.136
 - peak 4.64, 4.67, 4.124, 4.133
 - peak excursion 4.66
 - range 4.65, 4.135
 - Search method for peak list 4.41
 - Selftest 4.261
 - Sensitivity
 - APD measurement 4.174
 - CCDF measurement 4.174
 - Serial interface 8.6
 - configuration 4.250
 - Serial number 4.257
 - Serial poll 5.30
 - Service functions 4.259
 - Service request (SRQ) 5.22, 5.30
 - Service request enable register (SRE) 5.22
 - Setup 4.228
 - general 4.245
 - SETUP Key 4.228
 - Signal
 - amplitude statistics 4.169

- count 4.118
- search bandwidth 4.77
- tracking 4.77
- Single sweep 4.92
 - deactivating repeated sweep . 4.248
- Softkey
 - 6.172
 - % POWER BANDWIDTH4.167, 6.197
 - = CENTER 4.75, 4.76
 - = MARKER 4.75, 4.76
 - 0.1 * RBW 4.76, 6.174
 - 0.1 * SPAN 4.75, 6.174
 - 0.5 * RBW 4.76, 6.174
 - 0.5 * SPAN 4.75, 6.174
 - 1 MHz 4.20, 6.150
 - 10 DB MIN ON/OFF 4.17
 - 10 dB MIN ON/OFF 4.81, 6.124
 - 120 kHz 4.20, 6.150
 - 150 KHZ HIGHPASS 4.233
 - 2 FILE LISTS 4.273
 - 200 Hz 4.20, 6.150
 - 9 kHz 4.20, 6.150
 - ABSOLUTE PEAK/MIN . 6.15, 6.16
 - ACP LIMIT CHECK ... 4.161, 6.27
 - ACP REF SETTINGS4.159, 6.195, 6.196
 - ADD TO PEAK LIST ... 4.25, 4.64
 - ADJ CHAN BANDWIDTH ... 6.192
 - ADJ CHAN SPACING 6.191
 - ADJUST AXIS 4.57, 4.189
 - ADJUST REF LVL4.152, 4.168, 6.197
 - ADJUST SETTINGS4.174, 4.180, 4.185, 6.92, 6.196
 - ADJUST SETTINGS (occupied bandwidth) 4.168
 - ADJUST SETTINGS (power measurements) 4.161
 - ALL MARKER OFF4.62, 4.121, 6.13, 6.42
 - AM . 4.31, 4.131, 6.56, 6.161, 6.253
 - AMPERE 4.81
 - ANALYZER PRESET 4.263
 - ANNOTATION ON/OFF4.226, 6.103
 - APD ON/OFF. 4.172, 6.91, 6.94
 - ASCII FILE EXPORT4.38, 4.71, 4.106, 4.191, 6.113, 6.142, 6.143
 - AUTO COARSE 4.14
 - AUTO FINE 4.14
 - AUTO MAX PEAK 4.138
 - AUTO MIN PEAK. 4.138
 - AUTO PEAK SEARCH .4.127, 6.19
 - AUTO RANGE ON/OFF. 4.17
 - AUTO SELECT 4.111, 6.162
 - AUTOMATIC FINAL4.35, 4.41, 4.42, 4.43
 - AUTOPREAMP ON/OFF4.17, 6.125
 - AVERAGE4.28, 4.70, 4.103, 6.110, 6.148, 6.162
 - AVERAGE ON/OFF4.143, 6.76, 6.78, 6.80, 6.82, 6.84
 - AVG MODE 4.105
 - AVG MODE LOG/LIN . 6.88, 6.149
 - BARGRAPH MAXHOLD 4.224
 - BARGRAPH RESET 4.224
 - BLANK 4.70, 4.104, 6.111
 - BRIGHTNESS4.227, 4.278, 6.104, 6.114
 - C/N 4.179
 - C/NO 4.179
 - CAL ABORT. 4.114, 6.98
 - CAL CORR ON/OFF ... 4.114, 6.99
 - CAL GEN 128 MHZ ... 4.260, 6.100
 - CAL GEN COMB 6.100
 - CAL REFL OPEN4.291, 4.305, 6.154
 - CAL REFL SHORT4.291, 4.305, 6.154
 - CAL RESULTS 4.114, 6.99
 - CAL TOTAL 4.114, 6.98
 - CAL TRANS ... 4.286, 4.300, 6.154
 - CCDF ON/OFF ... 4.172, 6.91, 6.94
 - CCVS INT / EXT. 4.282, 6.209
 - CENTER 4.75, 6.174
 - CENTER = MKR FREQ 4.133, 6.60
 - CENTER A = MARKER B4.225, 6.129
 - CENTER B = MARKER A4.225, 6.129
 - CENTER FREQUENCY 6.174
 - CF STEPSIZE 4.75, 6.174
 - CHAN POWER ACP 6.64
 - CHAN PWR / HZ 4.160, 6.68
 - CHAN PWR ACP 4.149
 - CHANNEL BANDWIDTH4.156, 4.167, 4.179, 6.192
 - CHANNEL SPACING4.157, 6.190, 6.191
 - CISPR RBW UNCOUPLED ... 4.28
 - CISPR RMS 4.28
 - CLEAR ALL MESSAGES4.259, 6.230, 6.231
 - CLEAR/WRITE4.69, 4.102, 4.160, 6.110
 - CNT RESOL 4.122, 6.45
 - COLOR ON/OFF 4.277, 6.116
 - COLORS 4.275, 4.276
 - COM INTERFACE ... 4.250, 6.227
 - COMMAND TRACKING 4.260
 - COMMENT 4.275
 - COMMENT SCREEN A/B ... 6.118
 - CONFIG DISPLAY 4.225
 - CONFIGURE NETWORK 4.253
 - CONT AT HOLD 4.59
 - CONT AT REC FREQ 4.59
 - CONT DEMOD 4.132, 6.57
 - CONT MEAS . 4.175, 6.120, 6.121
 - CONTINUE SGL SWEEP4.92, 6.121
 - CONTINUOUS BARGRAPH ... 4.25
 - CONTINUOUS SCAN . 4.58, 6.120
 - CONTINUOUS SWEEP4.91, 6.120, 6.121
 - COPY 4.271, 6.135
 - COPY LIMIT LINE 4.212, 6.25
 - COPY TRACE ... 4.73, 4.108, 6.240
 - COUPLING DEFAULT 6.151, 6.204
 - COUPLING RATIO ... 4.86, 6.151
 - COUPLING TABLE 4.223
 - CP/ACP ABS/REL ... 4.160, 6.195
 - CP/ACP CONFIG4.155, 6.27, 6.191
 - CP/ACP ON/OFF4.149, 6.64, 6.65, 6.69
 - CP/ACP STANDARD ... 4.149, 6.69
 - CUT 4.271
 - DATA ENTRY OPAQUE 4.226
 - DATA SET CLEAR 6.134
 - DATA SET CLEAR ALL 6.135
 - DATE 4.272
 - dBm 4.18, 4.81
 - dBmA 4.81
 - dBmV 4.81
 - dBpT 4.18, 6.97
 - dBpW 4.18, 4.81
 - dBuA 4.18
 - dBuV 4.18
 - DECIM SEP4.38, 4.73, 4.108, 4.122, 4.130, 4.192, 6.113

- DEFAULT COLORS 4.226, 6.104, 6.114
 DEFAULT CONFIG 4.223, 4.268, 6.139
 DEFAULT COUPLING 4.88
 DEFAULT SETTINGS . . . 4.174, 6.94
 DELAY COMP ON/OFF 4.100, 6.254
 DELETE 4.238, 4.272, 6.136, 6.139, 6.158,
 6.160
 DELETE (peak list) 4.38
 DELETE FILE 4.268
 DELETE LIMIT LINE . . . 4.212, 6.26
 DELETE LINE 4.242
 DELETE RANGE 4.57, 4.189, 4.244
 DELETE VALUE 4.217
 DEMOD 4.30
 DEMOD ON/OFF 4.31, 6.161
 DETECTOR 4.27, 4.70, 4.111, 6.162
 DETECTOR AUTOPEAK 4.111, 6.162
 DETECTOR AVERAGE 4.112, 6.162
 DETECTOR CISPR AV 4.112
 DETECTOR CISPR RMS . . . 4.112
 DETECTOR MAX PEAK 4.112, 6.162
 DETECTOR MIN PEAK 4.112, 6.162
 DETECTOR QPK 4.112, 6.162
 DETECTOR RMS 4.112, 6.162
 DETECTOR SAMPLE . 4.112, 6.162
 DEVICE 1/24.275, 6.116, 6.117, 6.119,
 6.138, 6.228
 DEVICE SETUP 4.275
 DIAGRAM FULL SIZE 4.152
 DISABLE ALL ITEMS . 4.223, 4.267
 DISPLAY LINE 1/2 4.219
 DISPLAY PWR SAVE 4.226, 6.103, 6.104
 EDIT 4.240, 4.243, 6.156, 6.157, 6.159,
 6.160
 EDIT ACP LIMITS 4.162, 6.27, 6.28, 6.29,
 6.30, 6.31, 6.32
 EDIT COMMENT 4.266, 6.135
 EDIT FREQUENCY 4.38
 EDIT LIMIT LINE 4.214, 6.24, 6.34, 6.35,
 6.37, 6.39, 6.40, 6.41
 EDIT PATH 4.270, 6.134, 6.138
 EDIT PEAK LIST 4.34, 4.37
 EDIT SWEEP LIST . . . 4.187, 6.184
 EDIT TRD FACTOR 4.238
 ENABLE ALL ITEMS 4.223, 4.267, 6.139
 ENTER PASSWORD . . 4.260, 6.234
 ENV 216 4.46, 4.233
 ENV 4200 4.46, 4.233
 ESH2-Z5 4.46, 4.233
 ESH3-Z5 4.46, 4.233
 EXCLUDE LO 4.136, 6.46
 EXT AM 4.294, 6.210
 EXT FM 4.294, 6.210, 6.211
 EXT I/Q 4.295, 6.210
 EXT SOURCE 4.308
 EXT SRC ON/OFF . . . 4.309, 6.213
 EXTENSION 4.272
 EXTERN . . 4.60, 4.94, 6.206, 6.253
 FAST ACP ON/OFF . . . 4.151, 6.197
 FILE MANAGER 4.269, 6.134
 FILTER TYPE 4.20, 4.88, 6.151
 FINAL AVERAGE 4.71, 6.163
 FINAL CISPR AV 4.71
 FINAL CISPR RMS 4.71
 FINAL MAX PEAK 4.71, 6.163
 FINAL MEAS 4.36
 FINAL MEAS TIME 4.35, 4.41, 6.173
 FINAL MIN PEAK 4.71, 6.163
 FINAL PHASE 6.125
 FINAL PHASES 4.46
 FINAL QUASIPeAK 4.71, 6.163
 FINAL RMS 4.71, 6.163
 FIRMWARE UPDATE . 4.262, 6.231
 FM . 4.31, 4.131, 6.56, 6.161, 6.253
 FORMAT DISK 4.273, 6.136
 FREE RUN 4.60, 4.94, 6.253
 FREQ AXIS LIN/LOG 4.58, 4.79, 6.107
 FREQUENCY LINE 1/2 4.219
 FREQUENCY OFFSET 4.77, 4.293, 4.307,
 6.176, 6.211
 FREQUENCY SWEEP 4.313, 6.213, 6.214,
 6.215
 FSP MODE ON/OFF 6.234
 FULL SCREEN 4.222, 6.103
 FULL SPAN 4.78, 6.175
 GATE DELAY 4.98, 6.206
 GATE LENGTH 4.98, 6.206
 GATE MODE LEVEL/EDGE 4.98, 6.206
 GATE RANGES 4.177
 GATE SETTINGS 4.97, 6.205
 GATED TRIGGER 4.97, 4.176, 6.205,
 6.206
 GEN REF INT/EXT 4.315
 GENERAL SETUP 4.245
 GET MAXHOLD 4.44
 GPIB 4.246
 GPIB ADDRESS 4.246, 6.225
 GPIB LANGUAGE 4.246
 GRID ABS/REL 4.82, 6.108
 GRID MIN LEVEL 4.18, 6.109
 GRID RANGE LOG MANUAL . 4.18
 HARDCOPY ABORT 6.114
 HARDWARE INFO . . . 4.257, 6.102
 HARMONIC DISTOR 4.184
 HARMONIC ON/OFF 4.184
 HARMONIC RBW AUTO . . . 4.185
 HARMONIC SWEETIME . . . 4.185
 HOLD CONT ON/OFF 4.105
 HOLD FINAL MEAS 4.42
 HOLD SCAN . . 4.49, 4.51, 4.59, 6.11
 HOR SYNC 4.281, 6.255
 ID STRING FACTORY 4.246, 6.232
 ID STRING USER 4.246
 IF GAIN NORM PULS 6.232
 IF GAIN NORM/PULS 4.248
 IF POWER 4.95, 6.206, 6.253, 6.254
 INPUT CAL 4.259, 4.260, 6.100, 6.101
 INPUT RF 4.259, 4.260, 6.100
 INS AFTER RANGE 4.57, 4.188, 4.244
 INS BEFORE RANGE 4.57, 4.188, 4.244
 INSERT (peak list) 4.38
 INSERT LINE 4.242
 INSERT VALUE 4.217
 INSTALL OPTION 4.255
 INSTALL PRINTER 4.276
 INTERACTIVE 4.35, 4.41, 4.43
 ITEMS TO SAVE/RECALL . . 6.140
 LAST SPAN 4.79
 LEFT LIMIT 4.66, 4.130, 4.135, 6.43, 6.44
 LIMIT ON/OFF 4.142, 6.43
 LINES 625 / 525 4.282, 6.255
 LINK MKR1 AND DELTA 14.121, 6.17
 LISN 4.232
 LIST EVALUATION 4.190

- LOCAL 4.10, 5.7
 LOGO ON/OFF 4.225, 6.103
 MAKE DIRECTORY 6.137
 MANUAL 4.76
 MARGIN 4.35, 4.41, 4.191, 6.90
 MARKER 1 4.116, 6.15, 6.42, 6.46
 MARKER 1/2/3/4 4.60, 6.14
 MARKER 2 4.116, 6.15, 6.42, 6.46
 MARKER 3 4.116, 6.15, 6.42, 6.46
 MARKER 4 4.116, 6.15, 6.42, 6.46
 MARKER DEMOD 4.131, 6.56
 MARKER NORM/DELTA 4.60, 4.116, 6.13,
 6.17
 MARKER TRACK 4.64, 6.45
 MARKER ZOOM 4.67, 4.120, 6.55
 MAX HOLD 4.69, 4.102, 4.160, 6.110
 MAX HOLD ON/OFF 4.143, 6.77, 6.78,
 6.81, 6.83
 MAX PEAK 4.27, 4.70, 6.162, 6.163
 MAX/MIN THRESHOLD 6.171
 MAX-MIN THRESHOLD 6.171
 MEAN 4.142, 6.79, 6.80
 MEAS TIME 4.29, 6.204
 MEASURE 4.43, 4.44
 MIN 4.65, 4.136, 6.16, 6.49
 MIN HOLD 4.71, 4.105, 6.110
 MIN PEAK 4.28, 4.70, 6.162
 MKR -> CF STEPSIZE 6.60
 MKR -> STEPSIZE 4.65, 6.60
 MKR -> TRACE 4.61, 4.64, 4.67
 MKR DEMOD ON/OFF 4.131, 6.56
 MKR FILE EXPORT 4.122
 MKR STOP TIME 4.132, 6.57
 MKR->CF STEPSIZE 4.135
 MKR->TRACE 4.121, 4.132, 4.135, 6.14,
 6.42
 MODULATION 4.294
 MODULATION DEPTH 4.180, 6.57, 6.58
 MODULATION OFF 4.295, 6.210
 MULT CARR ACP 4.149
 N DB DOWN 4.128, 6.53, 6.54
 NAME 4.215, 4.272, 6.24, 6.26, 6.34, 6.35,
 6.38, 6.40
 NB/BB DISCR 4.34
 NETWORK 4.297, 4.298
 NETWORK LOGIN 4.254
 NEW 4.240, 4.243, 6.158
 NEW FACTOR 4.238
 NEW FOLDER 4.268, 4.270
 NEW LIMIT LINE 4.214, 6.24, 6.25, 6.26,
 6.34, 6.35, 6.37
 NEW SEARCH 4.129
 NEXT MIN 4.65, 4.136, 6.16, 6.49, 6.50
 NEXT MIN LEFT 4.65, 4.136
 NEXT MIN RIGHT 4.65, 4.136
 NEXT PEAK 4.64, 4.134, 6.15, 6.16, 6.17,
 6.47, 6.48
 NEXT PEAK LEFT 4.64, 4.134
 NEXT PEAK RIGHT 4.64, 4.134
 NEXT RANGES 4.189
 NO OF PEAKS 4.34, 4.40, 6.90
 NO OF SAMPLES 4.173, 6.92
 NO. OF ADJ CHAN 4.155, 6.192
 NO. OF HARMONICS 4.185
 NO. OF TX CHAN 4.156, 6.191
 NOISE CORR ON/OFF 4.151, 6.198
 NOISE MEAS 4.124, 6.55, 6.56
 NOISE SRC ON/OFF 4.263, 6.101
 NORMALIZE 4.287, 4.301, 6.154
 NUMBER OF SWEEPS 4.144, 6.204
 OCCUP BW ON/OFF 4.167, 6.64, 6.65,
 6.69
 OCCUPIED BANDWIDTH 4.167, 6.64
 OFF 4.46, 4.233
 OPTIMIZED COLOR SET 4.277
 OPTIONS 4.255
 PAGE DOWN 4.115, 4.239, 4.261
 PAGE UP 4.115, 4.239, 4.261
 PARAM COUPLING 4.222
 PASTE 4.271
 PE FLOATING 4.46, 4.233, 6.125, 6.172
 PE GROUNDED 4.46, 4.233, 6.125, 6.172
 PEAK 4.64, 4.67, 4.124, 4.133, 4.141, 6.15,
 6.47, 6.75
 PEAK EXCURSION 4.66, 4.130, 4.136,
 6.50
 PEAK LIST 4.129, 6.51
 PEAK LIST EXPORT 4.130
 PEAK LIST OFF 4.130, 6.51
 PEAK LIST ON / OFF 4.71
 PEAK LIST ON/OFF 4.71, 6.111
 PEAK SEARCH 4.37, 4.120, 4.127, 4.190,
 6.19, 6.89
 PEAKS PER PEAKS 4.190
 PEAKS SUBRANGES 4.41
 PEAKS/SUBRANGES 6.90
 PERCENT MARKER 4.172, 6.47
 PH NOISE ON/OFF 4.127, 6.19, 6.20
 PHASE L1 4.46, 4.233, 6.125
 PHASE L2 4.46, 4.233, 6.125
 PHASE L3 4.46, 4.233, 6.125
 PHASE N 4.46, 4.233, 6.125
 PHASE NOISE 4.125, 6.19
 POLARITY POS/NEG 4.60, 4.95, 4.98,
 6.206, 6.255
 PORT 0 0/1 4.249
 PORT x 0/1 6.146
 POWER ABS/REL 4.143, 6.84
 POWER MODE 4.160, 6.70
 POWER OFFSET 4.284, 4.298, 6.212
 POWER ON/OFF 4.141, 6.75, 6.77, 6.79,
 6.81, 6.85
 POWER SWEEP 4.296
 POWER SWP ON/OFF 4.296
 PREAMP ON/OFF 4.17, 4.235, 6.124
 PREDEFINED COLORS 4.228, 4.279,
 6.105, 6.115
 PRESCAN PHASE 6.125
 PRESCAN PHASES 4.46
 PRESELECT ON/OFF 4.234, 6.126
 PREV ZOOM RANGE 4.67
 PREVIOUS RANGES 4.189
 PRINT SCREEN 4.274, 6.117, 6.118, 6.138
 PRINT TABLE 4.275, 6.117, 6.118, 6.138
 PRINT TRACE 4.275, 6.117, 6.118, 6.138
 QP RBW UNCOUPLED 4.20, 6.151
 QUASIPEAK 4.28, 4.70, 6.162
 RANGE LIN % dB 6.109
 RANGE LINEAR 4.80, 6.109
 RANGE LINEAR % 4.80
 RANGE LINEAR dB 4.80
 RANGE LOG 100 dB 4.80, 6.109
 RANGE LOG MANUAL 4.80, 6.109
 RANGES 1-5/6-1 4.244

- RANGES 1-5/6-10* 4.57
RBW/VBW MANUAL 4.87, 6.152
RBW/VBW NOISE 4.87, 6.152
RBW/VBW PULSE 4.87, 6.152
RBW/VBW SINE 4.87, 6.152
RECALL 4.265, 4.290, 4.304, 6.137, 6.155
RECEIVER FREQUENCY 4.14, 4.25, 6.174
RECEIVER PRESET 4.263
REF FXD ON/OFF 4.119, 6.17
REF LEVEL 4.80, 6.108
REF LEVEL = MKR LVL 4.134, 6.60
REF LEVEL COUPLED 4.224, 6.129
REF LEVEL OFFSET 4.82, 6.108
REF LEVEL POSITION 4.82, 6.109
REF POINT FREQUENCY 4.119, 4.127, 6.19
REF POINT LEVEL 4.119, 4.127, 6.18
REF POINT LVL OFFSET 4.119, 4.127, 6.18
REF POINT TIME 4.120, 6.19
REF VALUE 4.288, 4.302, 6.109
REF VALUE POSITION 4.287, 4.301
REFERENCE FIXED 4.119, 6.17
REFERENCE INT/EXT 4.231, 6.199
REFLVL ADJ AUTO MAN 4.239
REMOVE OPTION 4.255
RENAME 4.271, 6.138
RES BW 4.19, 4.172, 6.150
RES BW AUTO 4.85, 6.151
RES BW MANUAL 4.84, 6.150
RESTORE FIRMWARE 4.262
RF ATTEN AUTO 4.81, 6.124
RF ATTEN MANUAL 4.16, 4.81, 6.124
RF INPUT 50 Ohm/75 Ohm 4.82, 6.126
RF INPUT AC/DC 4.18, 4.81
RF POWER 4.280, 6.253, 6.254
RIGHT LIMIT 4.66, 4.130, 4.135, 6.43, 6.44
RMS 4.28, 4.70, 4.141, 6.77, 6.162
RUN FINAL MEAS 4.42
RUN PRE-SCAN+FINAL 4.58
RUN SCAN 4.35, 4.49, 4.58, 6.121
SATURATION 4.227, 4.278, 6.104, 6.114
SAVE 4.265
SAVE AS TRD FACTOR 4.290, 4.304
SAVE LIMIT LINE 4.218
SAVE TRD FACTOR 4.242
SAVE TRD SET 4.245
SCALING 4.173, 6.92
SCAN COUNT 4.70, 6.204
SCREEN COLORS 4.277
SCREEN TITLE 4.225, 6.107
SEARCH LIMIT OFF 4.66, 4.135, 6.43
SEARCH LIMITS 4.65, 4.135, 6.43
SEARCH NEXT LEFT 6.16, 6.17, 6.48, 6.50
SEARCH NEXT RIGHT 6.16, 6.17, 6.48, 6.50
SELECT GENERATOR 4.309, 6.225, 6.226, 6.227
SELECT ITEMS 4.266, 4.267, 6.140, 6.141
SELECT LIMIT LINE 4.211, 6.23, 6.24, 6.36, 6.39
SELECT MARKER 4.63, 4.67, 4.124, 4.133, 4.183, 6.42
SELECT OBJECT 4.226, 4.278
SELECT TRACE 4.69, 4.78, 4.102, 4.164, 6.74, 6.198
SELFTEST 4.261, 6.10
SELFTEST RESULTS 4.261, 6.101
SERVICE 4.259, 6.100
SET CP REFERENCE 4.151, 6.195
SET REFERENCE 4.143, 6.85
SET TO DEFAULT 4.279
SETTINGS COUPLED 4.65, 6.46
SGL SWEEP DISP OFF 4.93, 6.121, 6.122
SHIFT X LIMIT LINE 4.217, 6.35
SHIFT Y LIMIT LINE 4.218, 6.40
SIGNAL COUNT 4.118, 6.44, 6.45
SIGNAL STATISTIC 4.171
SIGNAL TRACK 4.77, 6.73
SINGLE BARGRAPH 4.25
SINGLE MEAS 4.175, 6.120, 6.121
SINGLE SCAN 4.58, 6.120
SINGLE SWEEP 4.92, 6.120, 6.121
SIZE 4.273
SKIP FREQUENCY 4.43
SOFT FRONT PANEL 4.255
SORT BY DELTA LIM 4.191
SORT BY DELTA LIMIT 4.38
SORT BY FREQUENCY 4.38, 4.191
SORT MODE 4.272
SORT MODE FREQ/LEVEL 4.130
SOURCE CAL 4.285, 4.299
SOURCE ON/OFF 4.284
SOURCE POWER 4.284, 4.298, 6.211, 6.215
SPAN MANUAL 4.78, 6.174
SPAN/RBW AUTO 4.87, 6.151
SPAN/RBW MANUAL 4.87, 6.151
SPLIT SCREEN 4.222, 6.103
SPURIOUS EMISSIONS 4.186
SPURIOUS ON/OFF 4.187
SQUELCH 4.31, 4.131, 6.57
STANDARD DEVIATION 4.142, 6.81, 6.82
START 4.15, 4.76, 6.175
START LIMIT 4.142, 4.143, 6.43, 6.44
START MEAS 4.189
START POWER 4.296, 6.212
STARTUP RECALL 4.268, 6.137
STATISTICS 4.257, 6.9
STEPSIZE 4.14, 6.174
STEPSIZE = FREQ 4.15
STEPSIZE MANUAL 4.14
STEPSIZE STANDARD 4.122
STEPSIZE SWP POINTS 4.122
STOP 4.15, 4.77, 6.175
STOP FINAL MEAS 4.43, 4.44
STOP LIMIT 4.142, 4.143, 6.44
STOP MEAS 4.189, 6.11
STOP POWER 4.296
STOP SCAN 4.49, 4.51, 4.59, 6.11
SWEEP COUNT 4.92, 4.104, 6.204
SWEEP LIST 4.187, 6.181, 6.182, 6.183, 6.184, 6.185
SWEEP POINTS 4.93, 6.208
SWEEP REP ON/OFF 4.248
SWEEP TIME 4.151
SWEETIME 4.98
SWEETIME AUTO 4.86, 4.92, 6.204
SWEETIME MANUAL 4.78, 4.85, 4.92, 6.204
SYSTEM INFO 4.257

- SYSTEM MESSAGES 4.258, 6.230, 6.231
 T1-T2 6.87
 T1-T2->T1 4.113
 T1-T3 6.87
 T1-T3->T1 4.113
 THRESHOLD 4.66, 4.130, 4.135, 6.95
 THRESHOLD ON/OFF 4.34
 THRESHOLD SCAN ... 4.33, 6.171
 TIME DOM POWER 4.141, 6.75, 6.77,
 6.79, 6.81
 TIME DOMAIN 4.58
 TIME LINE 1/2 4.220
 TIME+DATE ... 4.252, 6.229, 6.235
 TIME+DATE ON/OFF 4.225, 6.107
 TINT ... 4.227, 4.278, 6.104, 6.114
 TOI 4.183, 6.59
 TRACE MATH 4.113, 6.87
 TRACE MATH OFF ... 4.113, 6.87
 TRACE POSITION. ... 4.113, 6.87
 TRACK BW 4.77, 6.73
 TRACK ON/OFF 4.77, 6.73
 TRACK THRESHOLD ... 4.77, 6.73
 TRACKING 4.283
 TRANSDUCER 4.237, 6.156
 TRANSDUCER FACTOR 4.238, 6.156,
 6.157
 TRANSDUCER SET 4.238, 6.156, 6.158,
 6.160
 TRIGGER OFFSET ... 4.95, 6.254
 TUNE TO MARKER. ... 4.64, 6.60
 TV TRIG SETTINGS 4.281
 TV TRIGGER ON/OFF 4.281, 6.209
 UNIT 4.17, 4.81
 UPDATE PATH 4.262
 USE CURR SETTINGS 4.58
 USE SCAN TABLE 4.53, 6.201, 6.202
 USER DEFINED 4.277
 USER PORT 4.249, 6.126
 USER PORT IN/OUT. 4.249, 6.127
 VALUES ... 4.217, 6.34, 6.36, 6.39
 VBW LIN LOG 6.153
 VBW MODE LIN/LOG 4.90
 VERT SYNC 4.281, 6.255
 VERT SYNC EVEN FIELD 4.281, 6.255
 VERT SYNC ODD FIELD 4.281, 6.255
 VIDEO ... 4.60, 4.94, 6.253, 6.254
 VIDEO BW AUTO ... 4.85, 6.152
 VIDEO BW MANUAL ... 4.84, 6.152
 VIDEO POL POS / NEG 4.282, 6.256
 VIEW 4.70, 4.104, 6.110
 VIEW PEAK LIST 4.191
 VIEW TRANSDUCER 4.238
 VOLT 4.81
 WATT 4.81
 X * RBW 4.76, 6.174
 X * SPAN 4.75, 6.174
 X OFFSET 4.212, 6.34
 X-AXIS RANGE 4.173, 6.93
 X-AXIS REF LEVEL ... 4.173, 6.92
 Y OFFSET 4.213, 6.37, 6.40
 Y-AXIS MAX VALUE ... 4.174, 6.93
 Y-AXIS MIN VALUE ... 4.174, 6.93
 Y-UNIT %/ABS 4.173
 ZERO SPAN 4.78, 6.174
 ZOOM OFF 4.67
 Span 4.78
 Special characters 6.6
 Spectrum analysis mode 4.74
 Split screen 4.222
 Squelch function 4.131
 SRE (service request enable register) 5.22
 SRQ (service request) 5.22, 5.30
 Standard
 mobile radio 4.149
 Standard deviation 4.142
 Start frequency 4.76
 Statistics 4.169
 Status byte (STB) 5.22
 STATus OPErAtion register 5.24
 STATus QUEStionable register 5.25
 ACPLimit register 5.26
 FREQuency register 5.27
 LIMit register 5.27
 LMARgin register 5.28
 POWer register 5.28
 Status register
 CONDition part 5.19
 ENABle part 5.20
 ESE 5.23
 ESR 5.23
 EVENT part 5.20
 NTRansition part. 5.19
 overview 5.21
 PPE 5.23
 PTRansition part. 5.19
 SRE 5.22
 STATus OPErAtion 5.24
 STATus QUEStionable ACPLimit 5.26
 STATus QUEStionable FREQuency 5.27
 STATus QUEStionable LIMit ... 5.27
 STATus QUEStionable LMARgin 5.28
 STATus QUEStionable POWer. 5.28
 STB. 5.22
 structure 5.18
 sum bit 5.20
 Status reporting system 5.18
 resetting values 5.31
 STB (status byte) 5.22
 Stepsize 4.76
 center frequency. 4.75
 coupling 4.76
 receiver frequency 4.14
 Stop frequency 4.77
 Storing 8.2
 trace 4.191
 String 5.14
 SUBNET MASK 4.253
 Subrange maxima list 4.37
 Suffix 5.11
 Sum bit 5.20
 Supply voltage
 external noise source 4.263
 Sweep
 continue single sweep 4.92
 continuous 4.91
 count 4.92
 coupling 4.83
 free run 4.60, 4.94
 gated 4.96, 4.97
 range 4.187
 settings 4.91
 single 4.92
 time 4.78, 4.92
 time coupling 4.86

- Switching cycles 4.257
 - Sync signal 4.281
 - Syntax elements 5.15
 - of commands 5.15
 - System messages 4.258
- T**
- Test
 - selftest 4.261
 - Test receiver 4.11
 - Text parameter 5.14
 - Third order intercept 4.181
 - Threshold
 - line 4.66, 4.135
 - signal tracking 4.77
 - Time 4.225
 - axis 4.78
 - input 4.252
 - line 4.220
 - Time domain analysis 4.50
 - Tint 4.227
 - Title for the active diagram 4.225
 - TOI 4.181
 - Trace 4.68, 4.69, 4.101, 4.102
 - averaging 4.103, 4.105
 - blank 4.70, 4.104
 - clear/write 4.69, 4.102
 - copy 4.73, 4.108
 - freeze 4.70, 4.104
 - info 4.113
 - math 4.113
 - max hold 4.69, 4.102
 - min hold 4.71, 4.105
 - position for 0 difference 4.113
 - power measurement 4.164
 - select 4.68, 4.101
 - signal tracking 4.78
 - storing (ASCII format) 4.191
 - Trace info 4.113
 - Trace mode
 - average 4.103
 - blank 4.104
 - clear/write 4.102
 - max hold 4.102
 - view 4.104
 - Tracking generator 4.283
 - Transducer 4.235
 - activating 4.236
 - editing 4.239
 - entry 4.239
 - set 4.242
 - Transmission measurement (built-in tracking generator) 4.285
 - Transmission measurement (external generator) 4.299
 - Trigger
 - external 4.60, 4.94
 - external gate 4.97
 - free run 4.60, 4.94
 - gated sweep 4.98
 - IF power 4.95
 - offset 4.95
 - RF power 4.280
 - scan 4.59
 - slope 4.60, 4.95
 - sweep 4.93
 - video 4.94
 - TV trigger 4.281
- U**
- Unit
 - level axis 4.81
 - limit line 4.216
 - Universal command 8.4
 - Upper case 6.6
 - User port 4.249
 - configuration 4.249
- V**
- Vertical sync signal 4.281
 - Video bandwidth 4.84
 - Video polarity 4.282
 - Video triggering 4.94
 - View trace 4.104
 - V-networks 4.232
- W**
- Weighting modes 4.29
 - White space 5.15
- Z**
- Zero span 4.78
 - Zoom 4.120
 - amplitude 4.70, 4.104
 - x axis (gate signal) 4.98

